

Acknowledgements

Hendricks County would like to thank the following people who served on the Ronald Reagan Corridor Master Plan Steering Committee:

Hendricks County

Sonya Cleveland, County Commissioner
 Larry Hesson, County Councilman
 Wayne Johnson, County Councilman
 Steve Ostermeier, County Commissioner
 Linda Palmer-Ryser, County Commissioner

Brownsburg

Bill Guamery, Brownsburg Town Council
 Robert Waggoner, Brownsburg Town Council

The Indianapolis Airport Authority

Lori Dunlap

Avon

Dave Jackson, Avon Town Council
 Bill Peebles
 Annemarie Varga, AICP

Plainfield

Robin Brandgard, Plainfield Town Council
 Bill Kirchoff, Plainfield Town Council

The committee would also like to thank the following people for their input into the planning process:

County Representatives

Don Reitz, AICP, Hendricks County Planning Director
 John Ayres, Hendricks County Engineer
 Greg Steuerwald, Hendricks County Attorney

Stakeholders

The Indianapolis Airport Authority
 Brownsburg Town Council
 Brownsburg Plan Commission
 Avon Town Council
 Avon Plan Commission
 Plainfield Town Council
 Plainfield Plan Commission

Other Advisors

Terry Smith, AICP
 Todd Barker, AICP

HNTB Design Team

David Wenzel, AICP, Vice President
 Ron L. Taylor, ASLA, Project Manager
 Annemarie Varga, AICP
 Jessica Foerster, ASLA
 John W. Myers, PE, AICP
 Rose A. Scovel, AICP

Contents

Table of Contents



Foreword vi.

Section 1 1

Background and History of the Ronald Reagan Corridor Master Plan

History.....	1-2
Steering Committee.....	1-5
The Planning Process.....	1-5

Section 2 2

Goals and Objectives for the Ronald Reagan Corridor Master Plan

Purpose of the Master Plan.....	2-2
Goals and Objectives.....	2-2
Goal #1: Inter-Governmental Cooperation.....	2-2
Goal #2: Land Use Planning.....	2-3
Goal #3: Corridor Enhancements and Site Design.....	2-4
Goal #4: Access Management.....	2-5
Goal #5: Non-Vehicular Transportation.....	2-5
Goal #6: Preservation of Unique Features.....	2-6

Section 3 3

Existing Natural and Built Conditions Within the Corridor Study Area

Study Area.....	3-2
Existing Land Uses in The Corridor.....	3-2
Existing Land Use Maps.....	3-4
Composite Inventory and Analysis.....	3-6
Natural Features.....	3-7
Utility Service Area.....	3-8
Restricted Lands.....	3-8
Existing and Planned Transportation Improvements.....	3-10
Existing Conditions Conclusions.....	3-11

Section 4 **4**

Planning in Hendricks County, Brownsburg, Avon, and Plainfield

Planning.....4-2
 Brownsburg Comprehensive Plan.....4-3
 Avon Comprehensive Plan.....4-3
 Plainfield Comprehensive Plan.....4-4
 Hendricks County Comprehensive Plan.....4-4
 Areas of Conflict Between Plans.....4-4
 Planning-Related Conclusions.....4-5

Section 5 **5**

Development of a Preferred Land use Scenario For the Ronald Reagan Parkway

Recent Trends and Market Conditions.....5-2
 Recent Development Trends – Proximate to Corridor.....5-4
 Definitions.....5-5
 Land Use Scenarios.....5-6
 True Market Scenarios.....5-7
 Alternative Development Scenario #1: Modified Market Alternative.....5-7
 Alternative Development Scenario #2: Aggressive Intervention.....5-8
 Preferred Land Use Scenario.....5-10
 Conclusions.....5-15

Section 6 **6**

Transportation Enhancements

Corridor Design Enhancements.....6-2
 Opportunities And Constraints.....6-3
 Alternative Design Concepts Exercise.....6-5
 Conceptual Design Summary.....6-6
 Baseline: The Roadway.....6-7
 Landscape and Lighting Enhancements.....6-8
 Gateway Elements.....6-18
 Wayfinding Elements.....6-24
 Structural Elements.....6-27
 Pedestrian Amenities.....6-32
 Corridor Unification.....6-36
 Corridor Unification Recommendations.....6-39

Section 7 **7**

Access Management Planning for the Ronald Reagan Parkway

- What is Access Management?.....7-2
- Definition and Purpose of Access Management.....7-2
- Functional Classification.....7-3
- Location / Alignment.....7-4
- Cross Section.....7-4
- Access Control.....7-6
- Implementation of the Access Management Plan.....7-8

Section 8 **8**

Implementation

- Getting it Done.....8-2
- Ongoing Communications.....8-2
- Implementation Techniques.....8-2
- Financing Plan.....8-4
- Potential Staging of Construction.....8-6

Appendix 1 **A-1**

Model Interlocal Agreement Concerning an Area of Common Interest

Appendix 2 **A-2**

Model Overlay Ordinance

Appendix 3 **A-3**

Recommended Plant Species Charts

Appendix 4 **A-4**

Land Use Recommendations- 56th Street to Hendricks/Boone County Line

Foreword

This report documents the process of the development of a master plan for the new twelve-mile Ronald Reagan Parkway just east of Indianapolis. The new planned roadway will serve as a major north-south connector in Hendricks County, connecting Interstate 70 and the Indianapolis International Airport on the south end to Interstate 74 and beyond on the north.

The master plan contains three distinct components. A new land use plan was established to unify the varying independent community land use plans for the corridor. The preferred land use scenario developed as the final recommendation for land use development includes a broad range of uses with the goal of defining and attracting a desired level of development.

The roadway enhancements portion of the study identified the physical design characteristics that will be applied to the corridor to further reinforce the parkway as a premier economic development corridor. Design concepts included built gateway features, pedestrian and vehicular lighting treatments, bridge treatments, wall treatments, landscape treatments in medians and in the right of way, wayfinding signage, and general development standards. Design guidelines were developed for the corridor utilizing the design concepts developed for the project.

The third part of the study, access management, developed the engineering and traffic movement and management principles to be incorporated in the project.

The master plan will be implemented through the use of the standards and recommendations set for this in this document, and the zoning overlay district that was developed as part of the project.

One

Section 1: Introduction

**Background and History of
the Ronald Reagan Corridor Master Plan**

HISTORY

The growth of Hendricks County in recent years has been phenomenal, and today it is the second fastest growing county in the state. This growth is due in large part to an intricate network of highway, air, and rail transportation systems available in the Indianapolis metropolitan area (Hendricks County Economic Development Partnership, 2004). Hendricks County is located within the eight county Indianapolis Metropolitan Statistical Area (MSA) and is served by multiple interstates that connect important destinations across the country. These interstates include I-65, I-465, I-74, and I-70. In addition, growth in the County is driven by the new configuration of the Indianapolis International Airport with its new front door from the west off the newly constructed interchange with I-70. As a result of natural growth emanating westward into Hendricks County from Marion County, the new airport configuration, and other factors, Hendricks County will continue to be sensitive to the growth pressures of the City of Indianapolis and neighboring suburbs.

In the past decade, Hendricks County has experienced dramatic growth in population as it is pulled more firmly into the urbanized area of Indianapolis. Generally, the fastest growing areas in the Indianapolis region over the last 20 years have been in the areas located along the northern and western borders of Marion County, including Hendricks County. **FIGURE 1.1**, Hendricks County Town Population Growth, indicates the growth of the County's largest communities between 1990 and 2000.

As shown in **FIGURE 1.4** on page 1-4, the population of Hendricks County grew by 37.5% between 1990 and 2000, making it third in the state for overall population growth and second in the state for rate of growth in 2000. Looking more closely within Hendricks County, Avon was not yet a Town at the time of the 1990 Census. The Indiana Business Research Center estimated that between 1990 and 2000 Avon experienced a growth rate of 431%. Using that figure, Avon was the fastest growing municipality in not only the Metropolitan Area, but in the entire State of Indiana. While the actual growth rate of Avon can differ depending on the land area that was used to determine the approximate 1990 population, it is clear that the area is rapidly developing. Brownsburg has shown the second fastest growth (90.3%), followed by Plainfield (23%).

With this growth boom in Hendricks County, it has become more and more evident that there is a need for accommodating present and future transportation demands. Currently, the most important of these transportation needs is stronger and more efficient linkages between the communities of Brownsburg, Avon, Plainfield, and across the County, especially north and south. Hendricks County has determined that this need must be filled. Hendricks County and local governments have engaged in a visionary exercise to establish a plan to construct a corridor linking multiple interstates across the County. The goal is to eventually connect I-65 at the southern end of Boone County to I-70 in Hendricks County. The current project focuses on the 12-mile portion of this roadway between interstates I-70 and I-74 in Hendricks County.

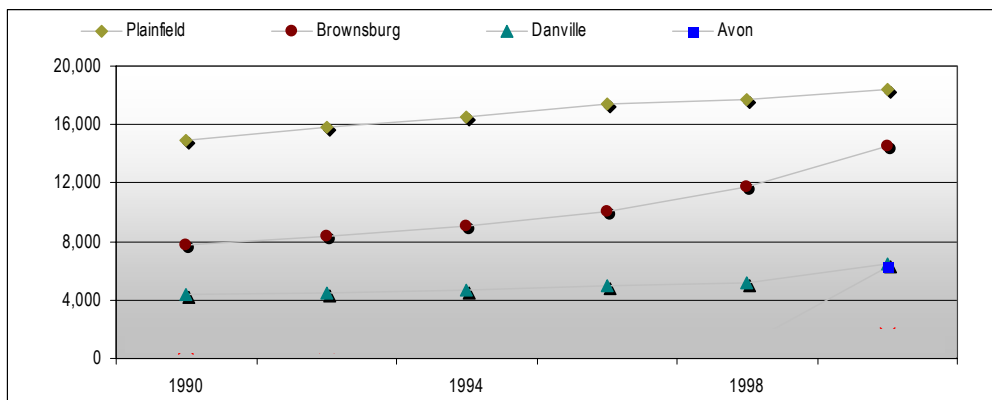

FIGURE 1.1: Hendricks County Town Population Growth

RONALD REAGAN

Corridor Master Plan

The intent of the Ronald Reagan Corridor Master Plan is to construct a 12-mile north-south connector linking I-70 to I-74 near the eastern boundary of the County. When complete, the 12-mile parkway will run from I-70 on the south, north through Plainfield and Avon tying into I-74 at Brownsburg. At this time, the location and alignment of the corridor are established, and a portion of the roadway has been constructed north of US 36, and the Interchange with I-70 is under construction. Commissioners of Hendricks County have initiated preliminary discussions with Boone County Commissioners to extend the roadway north to I-65, but an alignment for this potential extension has not been defined and this portion of roadway is not included in the scope of this study. **FIGURE 1.2** below illustrates the regional context of the project study area. **FIGURE 1.3** to the right further illustrates in more detail the project study area boundary, the existing and proposed alignment within the study area, and the potential future extension to I-65.

For the past decade, plans for the corridor have continuously evolved. An interchange justification report for the Six Points Road interchange and the southern leg of the parkway was prepared in 1992. An environmental impact study was preformed in 1993 and approved by the Federal Highway Administration in 1996. Once the alignment was set, the north-south corridor was named the "Ronald Reagan Parkway."

FIGURE 1.3: Project Location Map

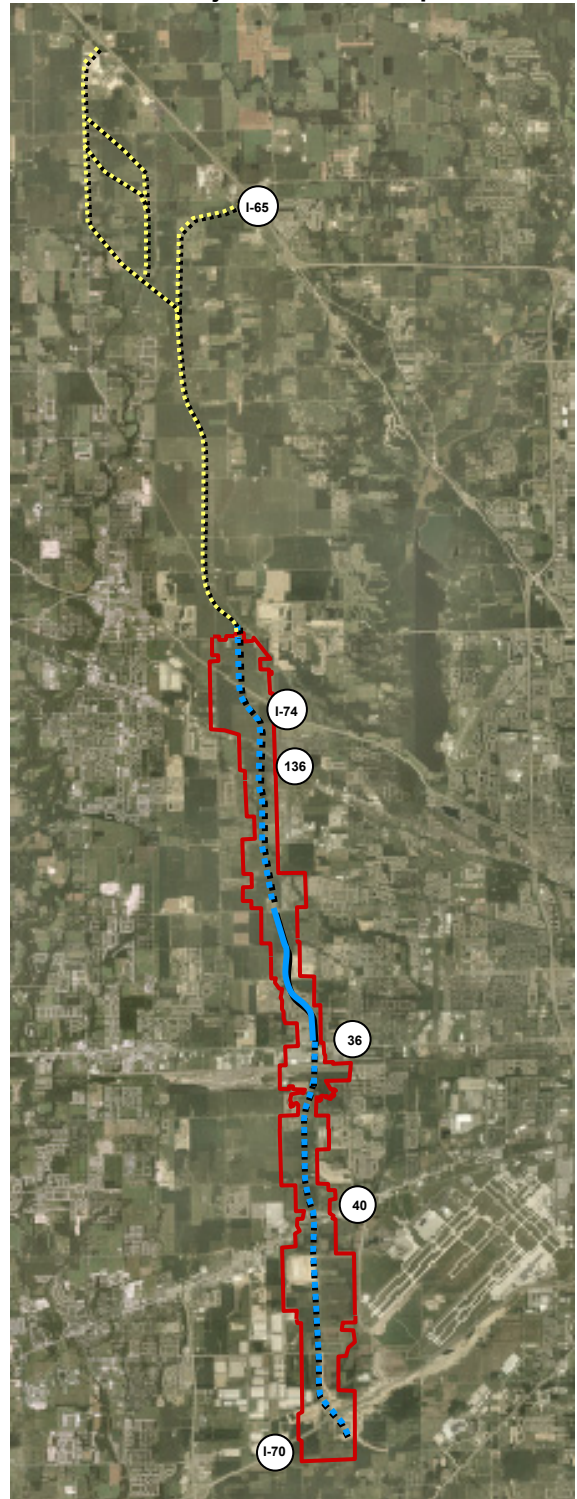

- STUDY AREA BOUNDARY
- RONALD REAGAN PARKWAY -BUILT
- - - RONALD REAGAN PARKWAY -PLANNED
- · · POTENTIAL FUTURE ALIGNMENT OPTIONS FOR EXTENSION TO I-65

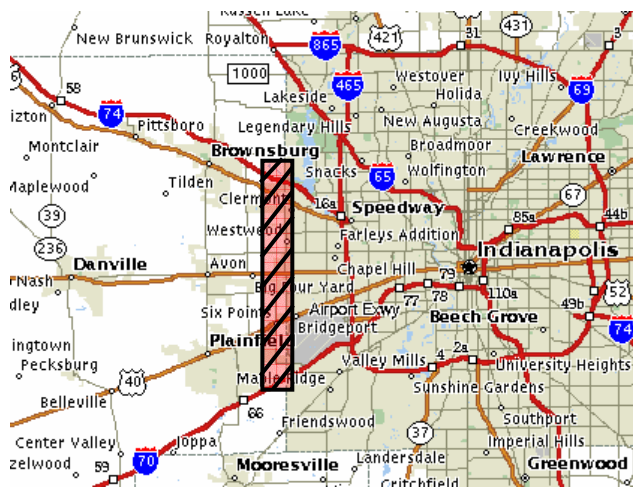

FIGURE 1.2: Regional Location Map-Project Study Area

Those who officially named the Parkway had the foresight and vision to establish a name that represents the values and rich future of our nation. They began with the goal to mold the development of this critical north-south connector, and made plans to establish it as a premier economic address in the region. Once the alignment of the parkway was in place, a steering committee was established to further define the vision of the future Ronald Reagan Parkway.

While the Ronald Reagan Parkway will provide critical north south accessibility, its dual function will be as an economic development corridor. Enormous economic opportunities await the development of the corridor. Much of this opportunity is driven by the new configuration of the Indianapolis International Airport. Its new entrance will come from the west, off the newly constructed interchange with I-70. As a result of the County's tremendous growth, the new airport configuration, and other economic factors, the development of the Ronald Reagan Corridor has the rare opportunity to become a brand new economic development corridor between two major interstates.

The purpose of the Ronald Reagan Corridor Master Plan is to create a collaborative plan that accomplishes three critical objectives for the County. The first objective is to preserve the integrity of the road function through access management planning. The second objective is to maximize the opportunities within the corridor to create a high level development through sound land use planning. Finally, the most important objective of the project is to establish a "premier economic address" by utilizing aesthetic treatments which will make the corridor appear as a twelve-mile unified, cohesive development campus.

Corridor Objectives:

- *Preserve the integrity of the road function through access management planning*
- *Maximize opportunity to create high-level development through sound land use planning*
- *Establish a "premier economic development address" by utilizing aesthetic treatments and design standards*

FIGURE 1.4: Populations Projections: 2000-2010

•Area	•1990	•2000	•% Change 1990-2000	•2010	•% Change 2000-2010
•Avon	•1,176 ¹	•6,248	•431.2%	•10,750	•72.0%
•Brownsburg	•7,628	•14,520	•90.3%	•19,385	•33.5%
•Plainfield	•14,953	•18,396	•23.0%	•22,627	•22.9%
•Hendricks County	•75,717	•104,093	•37.5%	•142,607	•36.9%

•Source: U.S. Census Bureau, Census 2000; Hendricks County Economic Development Partnership;

•¹ Indiana Business Research Center estimate of Avon's 1990 population

RONALD REAGAN

Corridor Master Plan

STEERING COMMITTEE

The Corridor area involves four local units of government including: Hendricks County, the Town of Avon, the Town of Brownsburg, and the Town of Plainfield. To direct the Ronald Reagan Corridor Master Plan implementation, two representatives from each of these local communities were appointed as part of a steering committee to oversee the development of the Plan. A list of these representatives is located in the Acknowledgements. The responsibility of this group was to act as a sounding board for establishing a set of goals and objectives, determining the direction of the land use plan and guiding the development of corridor enhancements and other treatments related to the development of the corridor.

THE PLANNING PROCESS

The planning process for the Ronald Reagan Corridor Master Plan was driven by input of steering committee members, key stakeholders, and local citizens. The result of the planning process will be a collaborative set of recommendations that will help to accomplish the objectives of the master plan through the implementation of access management recommendations, land use planning, and corridor design standards.

In September of 2003, the planning process was undertaken to establish the future direction and vision for the corridor. The planning team began the process with a kick-off meeting that was conducted in September 2003. The entire schedule for the planning process is outlined in **FIGURE 1.5**.

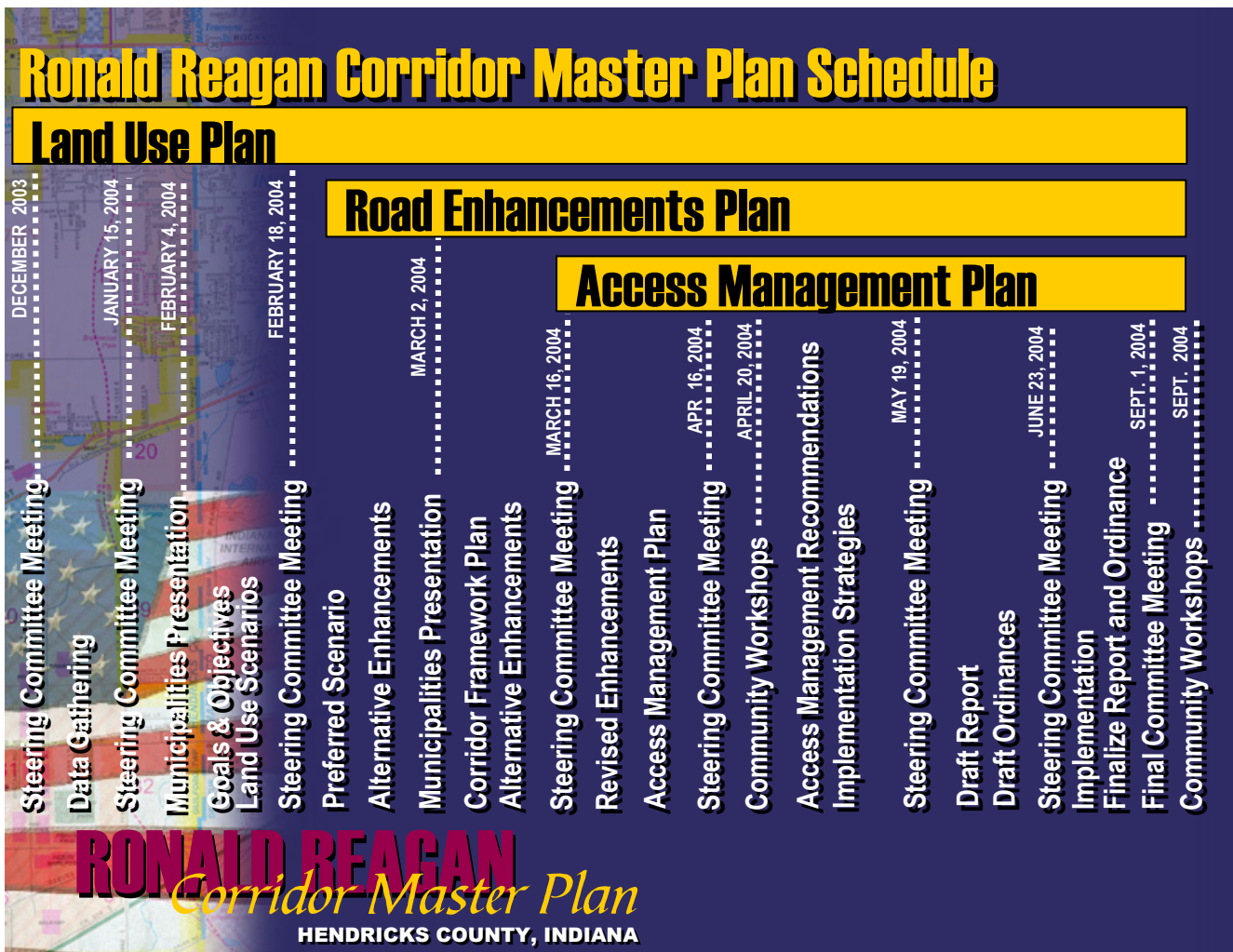

FIGURE 1.5: Ronald Reagan Corridor Master Plan Schedule

The outcome of the plan was guided in a large part by a series of steering committee meetings that were conducted on a monthly basis. The focus of these meetings was to review progress of the plan, present evolving concepts and ideas, and engage in a dialogue with the project team related to plan issues and concepts. The meetings focused on specific issues relating to land use, roadway enhancements, and access management. In order to gain feedback from the steering committee, the planning team initiated exercises to assist in the development of the project goals and objectives. These goals and objectives helped to guide the steering committee and project design team throughout the planning process. Other exercises that were utilized in the steering committee meetings included participatory surveys relating to issues such as land use principles, roadway enhancement treatments, and traffic management strategies.

Two briefings were held with elected officials from the County and participating municipalities to help gain an understanding of joint policy directions so that the recommendations reflect their common goals. These meetings provided valuable information to the local municipalities, and helped to further guide the project team with the progress of the plan.

In addition to the steering committee meetings, the project team conducted several one-on-one meetings with key stakeholders to explain the corridor planning process and concepts and to clarify any questions regarding the potential implications for specific communities or organizations. Interview sessions were conducted with key governmental, civic, business, and development leaders, as well as key land owners along the route. Key stakeholders included representatives from the Indianapolis Airport Authority and Indianapolis Raceway Park, Chamber of Commerce and Economic Development representatives, and representatives from the development community active in each of the communities.

The project team met with representatives of the Indianapolis Airport Authority and many of their key architects and engineers concerning land use and roadway alignments at and around the airport's proposed interchange on Interstate 70. These stakeholder meetings helped to establish appropriate and substantial development in this portion of the County that will meet the goals of the master plan.

A community workshop was also held about two-thirds of the way through the process as a means for informing the public on the progress of the plan and a platform for seeking the input from local citizens. The input provided by local citizens helped to define and reinforce the direction set by the steering committee and stakeholders. A final public meeting was held to present all of the recommendations.

The Ronald Reagan Corridor Master Plan, as outlined in this document, is the final result of the planning process as described above. This process resulted in a final set of recommendations for a future land use plan, access management guidelines, and roadway enhancements. These recommendations are described in detail in the following Sections of this document.

Two

Section 2: Goals and Objectives

**Goals and Objectives for the
Ronald Reagan Corridor Master Plan**

PURPOSE OF THE MASTER PLAN

The Ronald Reagan Parkway provides a rare opportunity to maximize transportation movement between two interstates through the establishment of a brand new economic development corridor. Our country and state have become littered with corridor projects which espoused transportation accessibility with economic development but resulted in poor access management and visual clutter, thereby damaging high-level economic development opportunities. These poor examples clue us in to the necessity of proper planning to ensure the highest and best development practices. The establishment of a master plan for the Ronald Reagan Parkway is a means of managing growth and development before it “just happens.” The guidelines set forth in this document are established as a means to protect the corridor from undesirable land uses and development practices. Without the establishment of goals, objectives, and sound development recommendations, the ultimate vision for the corridor will not be realized. Therefore, the implementation of the master plan is critical to the future success of the parkway. The master plan outlined in this document focuses on three very crucial objectives: to preserve the road function through access management planning, to maximize opportunities for high-level development through sound land use planning, and to develop a cohesive campus through the use of roadway enhancements. These objectives contribute to the overall goal of establishing a “premier economic address” within the region.

GOALS AND OBJECTIVES

The goals and objectives for the Ronald Reagan Corridor Master Plan were established based on information gathered from stakeholder interviews, goal setting exercises with the steering committee, and pertinent evaluation criteria. The project team conducted several interviews with key stakeholders including community and government officials as well as key property and business owners and major developers. The results of these interviews helped guide the project team to lead the steering committee in a goal setting exercise which was conducted at the first steering committee meeting. The goal setting exercise, administered in the form of a questionnaire, was accompanied by group exercises

which allowed the committee to contribute to the goal-building process. With this information in hand, the project team formulated a draft of the goals and objectives by synthesizing key recommendations into a series of strategic goals. The first draft of these goals was presented at the second steering committee meeting and was finalized throughout the process.

The goals for the Ronald Reagan Corridor Master Plan focus on six key outcomes. These include the following:

- Inter-governmental Cooperation
- Land Use Planning,
- Corridor Enhancements and Site Design
- Access Management
- Non-Vehicular Transportation
- Preservation of Unique Features

Each goal is a desired future condition. They are broad statements meant to introduce key concepts and ideas important to the corridor development. The goals express important values and desired outcomes for the community. Established for each goal is a list of objectives which are specific, measurable future conditions that indicate success in measuring the desired goal. The goals and objectives developed for the parkway are outlined as follows.

GOAL #1:

INTER-GOVERNMENTAL COOPERATION

Goal #1: Promote intergovernmental cooperation between Hendricks County and the Towns of Avon, Brownsburg, and Plainfield in the development of land along the Ronald Reagan Corridor.

Intergovernmental cooperation is critical to the success of the implementation of the master plan. In fact, it is probably the single most important goal of the plan, because without it, this corridor would not be able to be realized. The County and local municipalities have taken the first step by implementing this master plan. Open dialogue must continue throughout the process of the plan's implementation in order to ensure its success. This dialogue will help communities establish consistent criteria

for those decision-making parties participating in the development of the corridor. The goal of inter-government cooperation provides a road map for accomplishing specific objectives in the development of the corridor. In conjunction with this plan, an overlay ordinance was established which includes specific development guidelines for the corridor. This ordinance should be adopted by the local municipalities as a decision making tool relating to the development of the corridor. Inter-governmental cooperation will be one of the most important means for accomplishing the ultimate vision of the plan. The objectives for establishing intergovernmental cooperation are as follows:

- Encourage the Hendricks County Commissioners and the Brownsburg, Avon, and Plainfield Town Councils to adopt the Ronald Reagan Corridor Master Plan as the prevailing land use plan for development within the limits of the corridor.
- Adoption of the Ronald Reagan Corridor Overlay District by the Hendricks County Commissioners and the Brownsburg, Avon, and Plainfield Town Councils. This overlay will provide criteria and guidelines, consistent between communities, to assist County and Town officials in decision making for development along the corridor.

GOAL #2:

LAND USE PLANNING

Goal #2: Preserve, protect, and enhance the character of the corridor, adjacent property values, and the economic viability along the corridor by managing future growth and development.

The second goal is to establish a land use plan that preserves the Parkway as an economic development corridor. This goal will be accomplished by:

- weighing potential land uses against tax revenue generated and land size required for use;
- restricting land uses within the corridor to those uses which create areas for economic development;
- and promoting the Parkway as a premier business address in the County.

Because of the market trends towards residential uses, various methods should be explored to attract those uses that are determined to be highly desired and supporting the goals of the land use plan for the corridor.

Incentives should be explored to attract highly desired uses. The local municipalities should explore incentives for attracting office developers to eastern Hendricks County. With incentives, the likelihood of establishing a Class A/B office complex will be much higher.

In addition, the Parkway land use plan should maximize opportunities to create complementary relationships between land uses such as establishing hospitality uses adjacent to the corridor and the expanding light industrial areas with flex-tenant uses.

The objectives for establishing a land use plan are as follows:

- Promote economic development within the Corridor Study Area, focusing on the areas of light industrial and flex tenant space.
- Reserve land for Class A and Class B office space, and explore incentives necessary for attracting office developers to eastern Hendricks County.
- Identify specialized target areas for expansion and development of bulk warehousing and distribution-related industrial uses along the Parkway.
- Restrict the development of heavy industrial uses within the Ronald Reagan Corridor study area.
- Capitalize on valuable rail-accessible land located adjacent to the CSX railroad near Avon by designating the area for future industrial development.
- Allocate area for Indianapolis Raceway Park-related tourism and other uses related to auto racing around the intersections of the Ronald Reagan Parkway and US 136 and I-74.
- Discourage commercial strip development, and require commercial concentrations to develop as focused nodes with internal drives and minimal impact to the mobility of traffic on the Ronald Reagan Parkway.
- Allocate area for medical-related facilities, offices, and services near the Clarian West Hospital located at CR 100N and the Ronald Reagan Parkway.

- Reserve land for Class A and Class B office space, and explore incentives necessary for attracting office developers to eastern Hendricks County.
- Restrict single-family residential development, except where recommended in designated infill areas, as shown on the Ronald Reagan Corridor Master Plan land use plan.

GOAL #3: CORRIDOR ENHANCEMENTS AND SITE DESIGN

Goal #3: Enhance the built environment of the Corridor through aesthetic, placemaking improvements along the Parkway which identify the Corridor as “premier economic address” and enhance the visual character of the built environment. Placemaking improvements should create a sense of arrival and departure to and from the Corridor, as well as a sense of place along the Corridor which reflects the values and culture which are unique to the Hendricks County Community.

Corridor enhancements are important to establishing a high level of visual integrity along roadways. Roadways that do not utilize enhancement mechanisms oftentimes suffer from a lack of a sense of place. Enhancements such as gateway features, special median treatments, tree plantings, ornamental lighting, and wayfinding signage can reinforce the roadway as a unified master-planned corridor. In addition, they can help to create a sense of arrival, making a strong visual impact on those who travel along the parkway. The third goal of the master plan is to utilize transportation enhancements along the corridor to establish a sense of place which reflects the values and culture which are unique to the Hendricks County community and to use high quality aesthetics to demand an equally high quality of development. The quality-level of the corridor will help in the attraction of high quality development, reinforcing the County’s vision of the corridor as a premier economic address. The objectives for corridor enhancements and site design are as follows:

- Adopt roadway design guidelines to direct the implementation of comprehensive streetscape design standards for landscaping, lighting, gateways, wayfinding signs, structural elements and pedestrian amenities throughout the Corridor.
- Establish key gateway areas which, through roadway design enhancements, create memorable entries to enhance the character of the area, and establish an identifiable image for the Parkway.
- Provide a uniform system of directional and informational signage that facilitates wayfinding and assists visitors and parkway users to clearly find destinations while also communicating the unique identity of the corridor
- Design structural elements not only as functional amenities, but to introduce a high level of design into all structural elements, reinforcing the parkway’s status as a premier business address.
- Create an overlay ordinance to address building setbacks, signs, parking lots, screening, landscaping, lighting and building design standards in order to create the appearance of a master planned development campus throughout the Corridor.
- Implement commercial and industrial development open space design standards to preserve scenic views and character, as well as woodlands, streams and wetlands.
- Apply special standards for height restrictions and noise sensitive uses where required by the standards put forth by the Indianapolis Airport Authority and the Indiana Tall Structures Act.



FIGURE 2.1: *Prototypical gateway enhancement treatments selected by the steering committee in an image preference survey.*

GOAL #4: ACCESS MANAGEMENT

Goal #4: Implement an access management plan that optimizes roadway function by keeping regional traffic moving through the corridor while preserving the safety and efficiency of the transportation system by allowing local traffic to efficiently and safely access businesses and destinations located along the parkway.

Access management is the systematic control of the location, spacing, design, and operation of driveways, median openings, interchanges and street connections to a roadway. It also involves roadway design applications such as median treatments and auxiliary lanes, and the appropriate spacing of traffic signals (Access Management Manual, Transportation Research Board, 2003). Access management utilizes these means to optimize the function of a roadway. The access management plan established for the parkway is intended to preserve the integrity of the roadway function. In addition, the implementation of an access management plan will reinforce the roadway as a consistent master planned corridor, while maintaining a high level of safety.

The objectives for implementing an access management plan include the following:

- Regulate the number, location and type of access points to each development along the Parkway.
- Remove local traffic from through traffic lanes by requiring shared access through frontage roads, rear service drives, shared driveways and connected parking lots.
- Create zoning and access management standards for the design of driveways and auxiliary lanes (i.e. right and left turn lanes, deceleration tapers, and exit lanes).

- Recommend roadway standards for the Ronald Reagan Parkway that permit the capacity of the transportation system to be consistent with the approved Ronald Reagan Corridor Master Plan land use plan. Such standards may include signalization, medians for channeling traffic, and auxiliary lanes to remove turning movements from through lanes.
- Set standard thresholds for requiring traffic impact studies for development within the Corridor.

GOAL #5 NON-VEHICULAR TRANSPORTATION

Goal #5: Promote transportation choices through the development of safe, attractive and accessible pedestrian ways, bicycle ways, and multi-use paths which are removed from vehicular traffic movements.

Non-vehicular transportation is integral to the overall transportation network within and beyond the corridor. Not only do amenities such as trails and walks play an important role in establishing a pedestrian-friendly environment, but they are crucial in establishing connectivity within the regional transportation network. A renewed emphasis on walking and its benefits, for health, economic, and environmental reasons, has placed pedestrian amenities on the priority list for the Ronald Reagan Parkway.



FIGURE 2.2: *Prototypical multi-use trail selected by the steering committee in an image preference survey as a model for the design treatments along the parkway.*

Objectives for promoting non-vehicular transportation choices include the following:

- Promote pedestrian trails as a high priority by requiring their utilization in all newly developed areas and along the entire length of the corridor.
- Establish appropriate locations for non-vehicular transportation (i.e. bicycles and pedestrians) which do not interfere with vehicular traffic patterns, and which create a safe environment for non-motorized transportation.
- Establish standards for pedestrian and bicycle access and crossings within the Corridor, most notably where the B&O Trail and other trail systems connect to the Ronald Reagan Parkway.

Objectives for the preservation of unique features include the following:

- Minimize damage to natural resources by encouraging the integration of wetlands, woodlands, and creeks into site development as functional and aesthetic features.
- Avoid the disturbance of lands designated as environmentally sensitive or as habitat for federally endangered or protected species.
- Encourage the use of native plant species and naturalized landscape designs, where appropriate, to enhance the corridor's existing character.
- Encourage the preservation of historic structures.

GOAL #6 PRESERVATION OF UNIQUE FEATURES

Goal #6: Protect environmentally sensitive and historic areas such as bat habitats, wetlands, woodlands, and historic sites and structures by requiring future development to be sensitive to the natural and historic features within the corridor.

Unique features in the corridor study area include natural and historic sites. Some lands in the study area are designated as environmentally sensitive or bat habitats. Development of these sensitive areas should be avoided. These features contribute to the existing local character of the corridor. In addition, natural features are integral to the function of regional systems. Developers are encouraged to integrate wetlands, woodlands, and creeks into site development as functional and aesthetic features. It is important that these features are recognized, and that preservation and conservation efforts are undertaken where appropriate. An ecologically sensitive approach will not only benefit the natural and cultural environment, but it will set standards for the future development in the region. Furthermore, the introduction of native plant species and naturalized landscape designs, where appropriate, are encouraged to enhance the desired natural character of the corridor.

Three

Section 3: Existing Conditions

**Existing Natural and Built Conditions
Within the Corridor Study Area**

STUDY AREA

The study area for the project includes the 12-mile corridor alignment running north/south through Hendricks County, and adjacent properties within approximately 1000 feet of the 12-mile corridor. The study area includes portions of incorporated Plainfield, Avon, and is immediately adjacent to Brownsburg. The parkway will ultimately connect I-74 and I-70 through the growth areas of Avon, Brownsburg, and Plainfield. Substantial open agriculture land and intermittent residential development makes up the study area. In addition, the study area traverses commercial and industrial areas running north/south through the County. **FIGURE 3.1** depicts the corridor study area boundary and some major destinations along the corridor. The solid blue line represents the portions of the corridor that are existing and the dashed represents the proposed future alignment. The areas included within the red boundary illustrate the extent of the study area that was considered in this master plan.

EXISTING LAND USES IN THE CORRIDOR

The corridor study area, with much of its land currently as agriculture, is prime for future land development. Current land uses along the corridor include substantial open agricultural land with some residential subdivisions. The current market for residential uses is currently very strong, and several residential subdivisions have been locating in and around the study area. Commercial and industrial uses are also concentrated in specific areas. In addition, several regional and local amenities are located along or near the corridor. The Indianapolis International Airport, although not fronting the corridor, will soon be reoriented to the west, bringing with it associated development which is anticipated to locate along the southern portions of the study area near I-70. Another regional amenity, the Indianapolis Raceway Park, sits adjacent to the parkway in the northern section of the study area. Other local destinations within the study area are highlighted in **FIGURE 3.1**. All of these destinations will have a large impact on the future development of the corridor. The following sections will describe in more detail the patterns of existing land use development along the corridor. **FIGURES 3.5-3.7** graphically depict the existing land uses within the study area. The classifications of land use are broken down into 11 categories: Agriculture, Cemetery, Commercial, Institutional, Industrial, Single Family Residential, Multi-Family Residential, Vacant Land/Natural Areas, Recreation, Utilities, and Water.

FIGURE 3.1: Study Area & Alignment

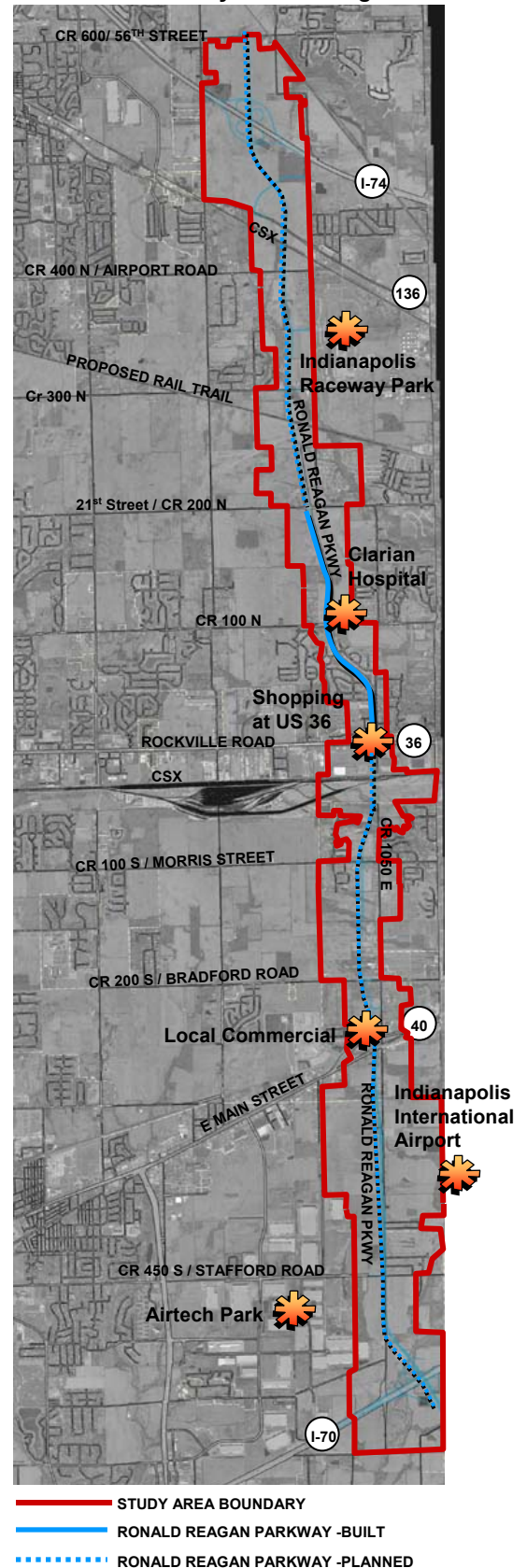

Agriculture

The largest use category within the study area is agriculture. In 1998, agriculture comprised approximately 72.2% of the land area in Hendricks County, or 187,118 acres. However, these rural areas are now becoming desirable locations for large single-family homes and subdivisions. The agriculture land use category generally includes land that is used for the production of food and fiber, but also includes land used for non-food livestock production such as horses. Agriculture land includes: cropland, confined feeding operations for any kind, permanent pasture lands, farmsteads, nurseries, and horse training areas. The total agriculture land use in the study area is approximately 2,922 acres, or 65% of the total land use.

Industrial

Industrial land use includes manufacturing and industrial parks, light industries that fabricate or package products, and transportation facilities that handle heavy materials. These land uses tend to have larger lot sizes (25 acres plus). Their demand is driven by workforce, transportation systems, and end users of the product. As with commercial land uses, industrial land uses tend to locate near major transportation systems. An example of this is the location of Airtech Park just north of I-70. The total industrial land use in the study area is approximately 236 acres, or approximately 5% of the total land use.

Commercial

The commercial land use category includes classifications related to the sale of products and services such as central business districts, shopping centers/malls, strip commercial, and neighborhood stores that are surrounded by noncommercial uses. Examples within the study area include shopping centers at Shiloh Crossing, Avon Commons, and the Raceway Plaza shopping center. This category includes parking areas related to the commercial businesses. These retail land uses tend to have smaller lot sizes (5 acres plus) and tend to locate proximate to major transportation arterials. The total commercial category land use in the study area is approximately 167 acres, or 4% of the total acres.



FIGURE 3.2: *Much of the existing study area is still comprised of agricultural lands*

Institutional

Institutional land uses include a variety of classifications such as education, government, religious, health, correctional, and any military facilities. Institutional land uses in the corridor include the New Clarian Hospital located at CR 100 North. The total number of acres of institutional land use in the corridor study area is 47 acres, or 1% of the total land use.

Recreational

Recreational land uses include all indoor and outdoor recreational facilities, and pedestrian/bicyclist trails. The buildings, parking areas, and immediate grounds are included in this category. Significant recreational land uses have been identified within the study area and nearby, including the Indianapolis Raceway Park and campground, and the Clermont golf course. The total recreational land use in the study area is approximately 103 acres, or 2% of the total land use.



FIGURE 3.3: *Indianapolis Raceway Park*

Residential

Residential land use includes residential dwelling structures such as single family or townhomes, multi-family low rise, multi-family high rise, and mobile home parks. Existing residential communities within or near the study area include: County Meadows, Lake of the Lanterns, Waverly Commons, Avon Trails, Ashton, Shiloh Farms, Glen Elen, Sun Chase, Huntwick, Meadowlark, Brentwood Park, Oakhurst, Clermont Heights, Sunny Meadows, Vondersa, Portwood Addition, Swalley's Addition, Reed's acres, Verdant Acres, and Medallion Meadows. The majority of residential dwellings in the study area are single-family. The total residential land use in the study area is approximately 580 acres, or 14% of the total land use.

The remaining vacant lands and natural areas total approximately 10% of the study area.



FIGURE 3.4: *New residential developments have been occurring near and within the study area*

EXISTING LAND USE MAPS

The following maps in **FIGURES 3.5-3.7** illustrate the land use patterns that currently exist within the corridor. These plans are broken into three sections. The legend to the right corresponds to each of the three land use maps that follow.

A	Agriculture
CE	Cemetery
C	Commercial
M	Institutional
I	Industrial
SF	Single-family
MF	Multi-family
N	Vacant Land / Natural Areas
P	Recreation
U	Utilities
	Water

FIGURE 3.5: Existing Land Use - North

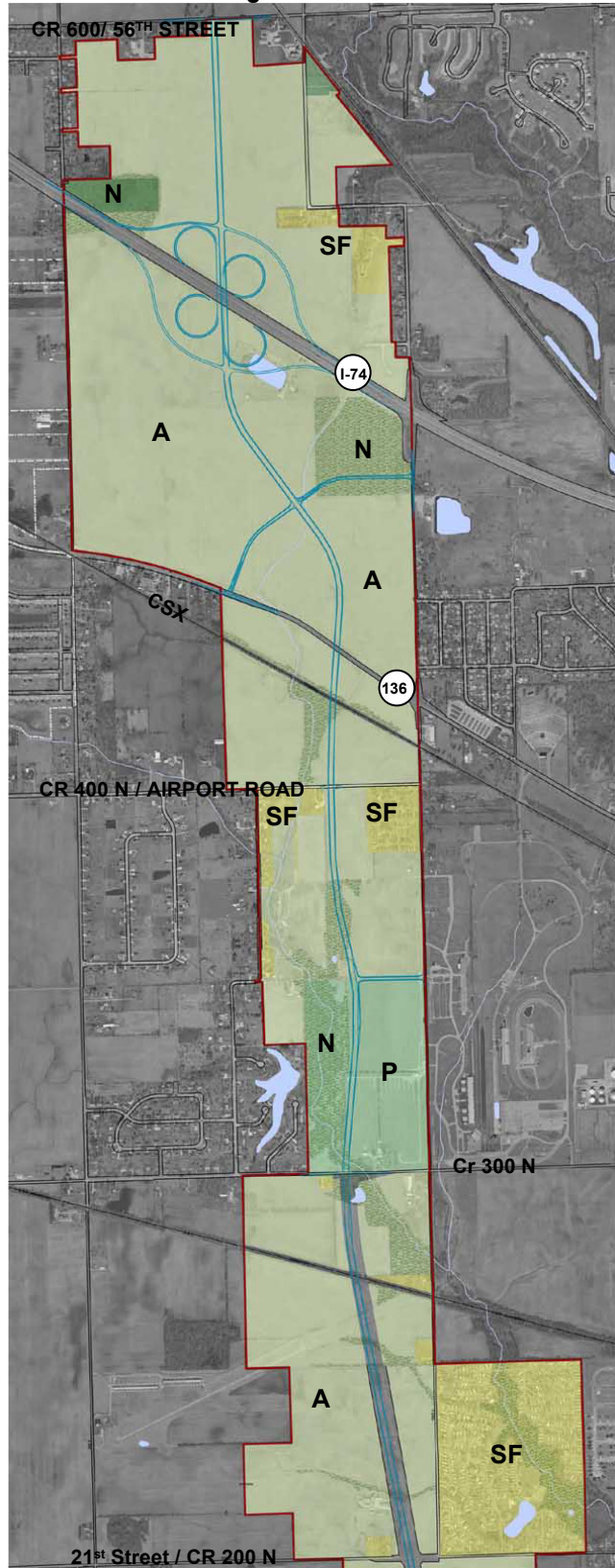

FIGURE 3.6: Existing Land Use - Center

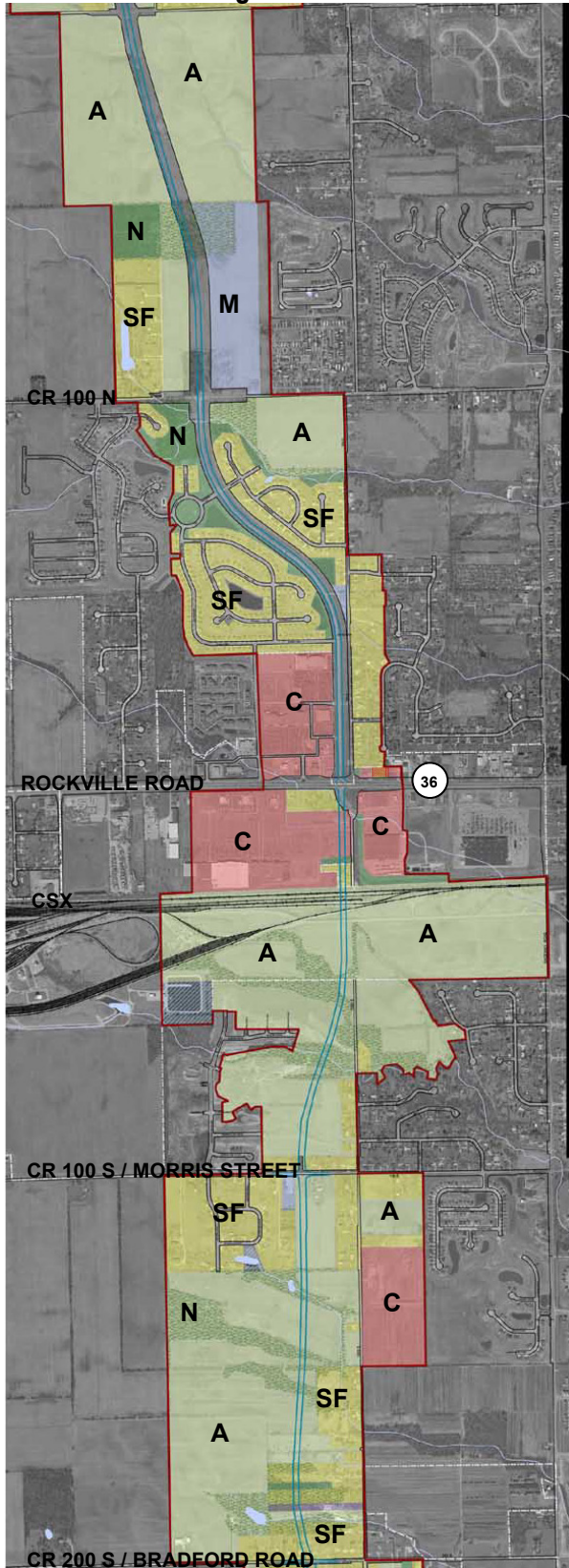
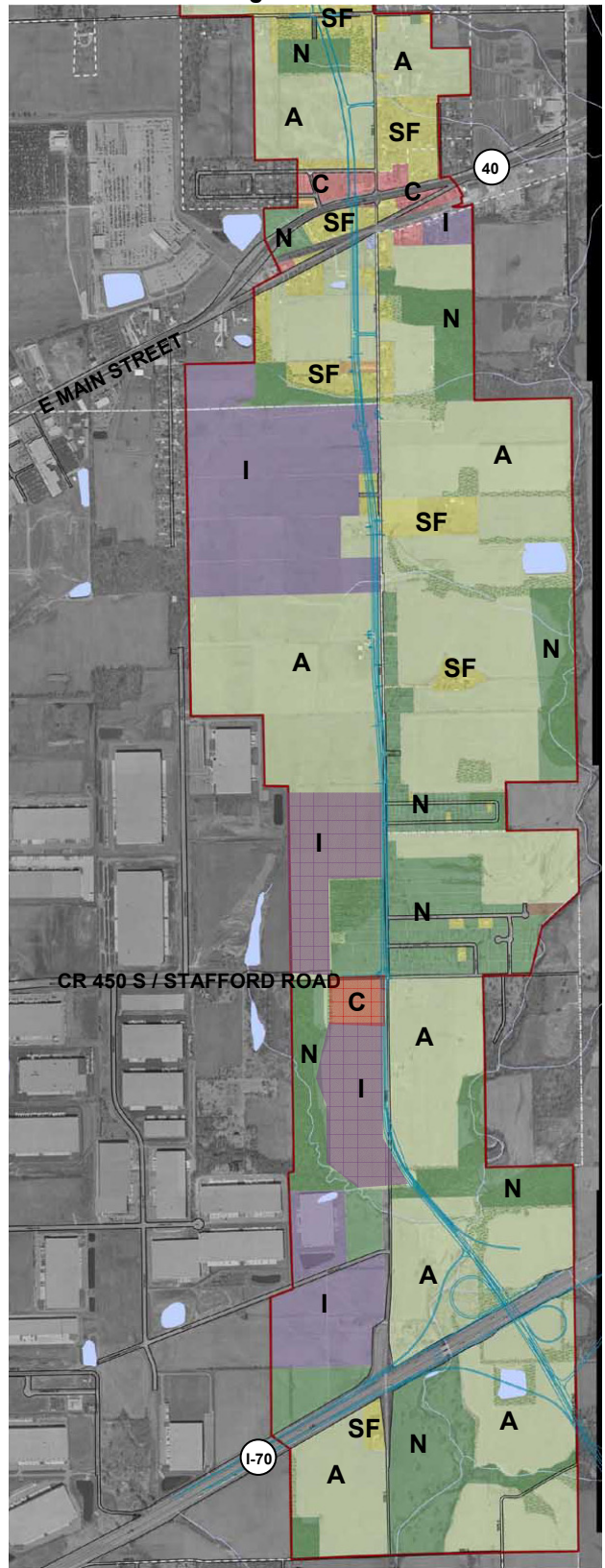

FIGURE 3.7: Existing Land Use - South



As seen in the existing land use maps, the corridor is dominated by agricultural uses, with much open land for future development. The north section reinforces the prevalence of agricultural uses. There are many adjacent residential uses in this section, as agricultural land is slowly being developed with some single family dwellings. The north section also contains significant recreational uses within the corridor and nearby including Indianapolis Raceway Park and the Clermont Golf Course.

The center section has been more aggressively developed in recent years with commercial developments along US 36 and large-scale residential developments nearby. In addition, the new Clarian Hospital is located here along the corridor, at CR 100N. It is expected that without a land use plan in place, residential and commercial uses would expand to fill in the gaps of existing agricultural lands.

The southeast portion of the corridor contains a large amount of airport-owned lands which remain undeveloped. These tracts of land provide opportunities for airport-related uses, but some restrictions may apply such as building height clearance requirements and environmentally protected areas. Development in this area must therefore adapt to those conditions. The southwest portion of the study area is rapidly becoming industrial with the expansion of Airtech Park. It is anticipated that other light industrial uses will gravitate towards this area.

In order to guide the future of the corridor, consistent land use development patterns must be enforced. The steering committee undertook several exercises to generate a preferred land use scenario. The outcome of the preferred land use scenario exercises will be discussed later in Section 5. The goal was to establish a land use plan that maximized opportunities for economic development, created complementary relationships between development types, and established an overall unified corridor. The establishment of well-planned and consistent land use patterns is the first step in guaranteeing the success of the corridor master plan.

COMPOSITE INVENTORY AND ANALYSIS

Several layers of data were gathered about the local features within and near the study area in order to begin analyzing the area's unique opportunities and potential constraints. Data collected include political boundaries, historic sites, destinations, potential gateways, areas of restricted development, existing and planned transportation improvements, the locations of existing residential communities, and natural features. Much of this information has been compiled and translated into a series of inventory and analysis maps. Several of these maps are illustrated on the pages that follow.

The corridor crosses several political boundaries as shown in **FIGURE 3.8**. As discussed in the goals and objectives section, the awareness of these political boundaries and the relationships that must evolve and be maintained in order to accomplish this cross-county corridor plan is very important. Not only does the corridor cross several municipalities, but several important destinations are located along and near the corridor. Several key stakeholders were involved in the process of planning the corridor. These include the Indianapolis International Airport, the Indianapolis Raceway Park, the new Clarian Hospital campus, and Airtech Park. These destinations each provide unique opportunities that relate to their specific uses. **FIGURE 3.8** shows several small pockets of natural areas near the Parkway. Historic sites are also outlined on this map in red. These natural and historic features, along with the existing agricultural character of the corridor, are important to the heritage of the local region, and efforts should be made to preserve, enhance and enrich the natural and cultural landscape of the Parkway. The map also illustrates three key areas that have been identified as having the greatest opportunity for establishing gateways into the corridor. These are located at I-70, Rockville Road/ US 36, and I-74. Each of these key crossroads has the potential to not only develop as an economic node, but also to make a prominent gateway statement.

FIGURE 3.8: Inventory & Analysis

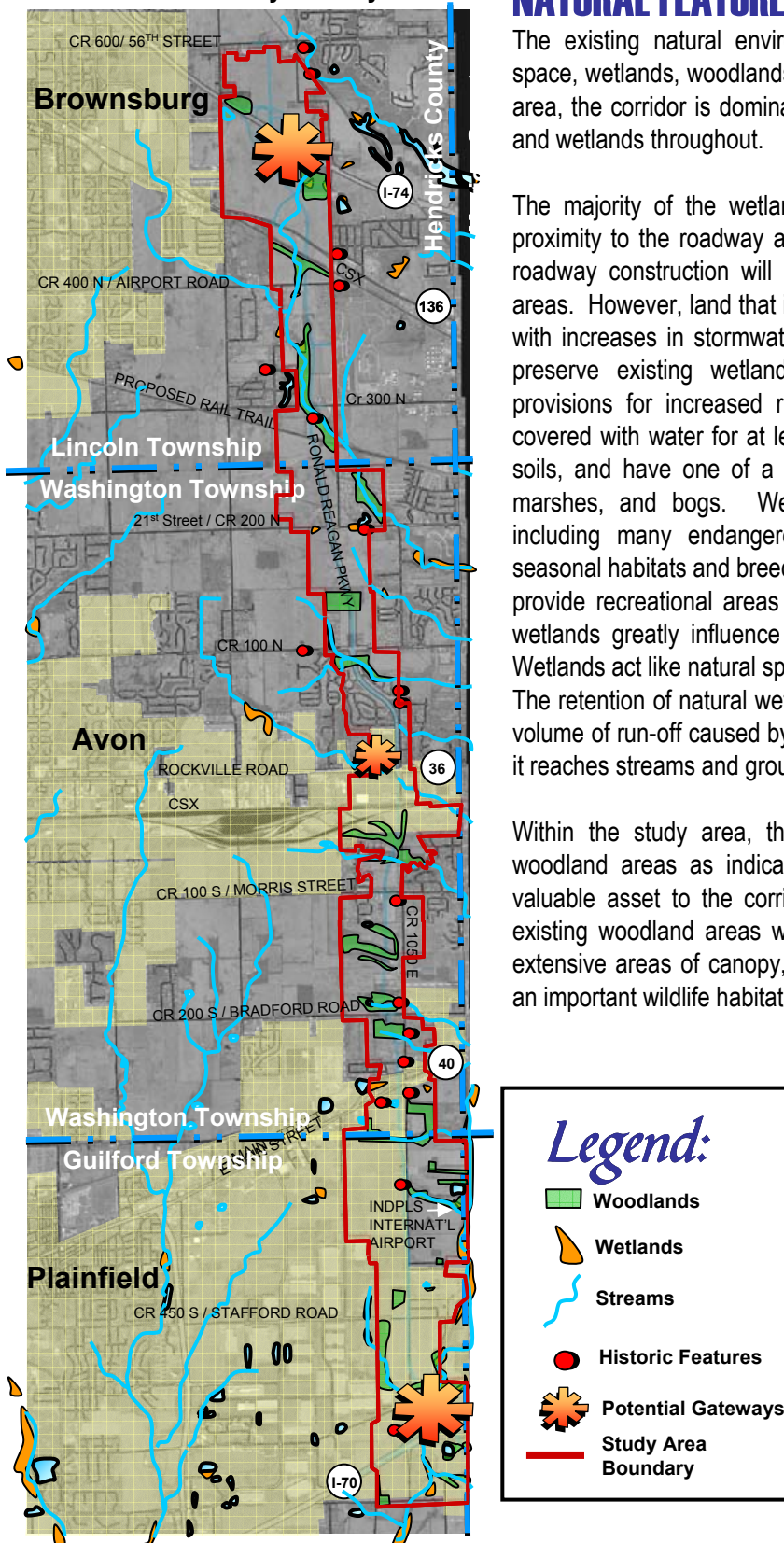

NATURAL FEATURES

The existing natural environment within the study area includes open space, wetlands, woodlands, streams and lakes. Typical of an agricultural area, the corridor is dominated by open space with pockets of woodlands and wetlands throughout.

The majority of the wetlands within the study area are not located in proximity to the roadway alignment. Therefore, it is anticipated that the roadway construction will not have a significant impact on the wetland areas. However, land that is developed will ultimately affect wetland areas with increases in stormwater runoff. Therefore, efforts must be made to preserve existing wetland areas where appropriate, and to provide provisions for increased runoff. Wetlands are areas of land that are covered with water for at least part of the year, have characteristic hydric soils, and have one of a number of distinct vegetation types: swamps, marshes, and bogs. Wetlands are home to many diverse animals, including many endangered species, and seasonal wetlands provide seasonal habitats and breeding grounds for certain species. Wetlands also provide recreational areas for hiking, bird watching and fishing. Finally, wetlands greatly influence the flow and quality of water in the County. Wetlands act like natural sponges, storing the water and slowly releasing it. The retention of natural wetlands can help control the increase in rate and volume of run-off caused by new construction, and cleans the water before it reaches streams and groundwater sources.

Within the study area, the corridor also traverses several pockets of woodland areas as indicated in **FIGURE 3.8**. These woodlands are a valuable asset to the corridor, and efforts should be made to preserve existing woodland areas where appropriate. Although they do not form extensive areas of canopy, these agricultural woodland remnants provide an important wildlife habitat and influence the corridor aesthetic.

Surface water, including areas such as lakes, ponds, rivers and streams, is located in a few areas within the study area. Lakes provide recreational opportunities (fishing & bird watching) for many residents within the area. Smaller-sized ponds are most often artificially created, and often times used for storm water runoff and recreational purposes for residential and agricultural developments.

Streams located in the study area include: School Branch, Bullard Creek, White Lick Creek, Brown Ditch, Comb Run, Cox Ditch, Clarks Creek, Salem Creek, Dead Run, Bridge Creek, Klondike Creek, Bluff Creek, Middle Creek, and Roger Creek. These water features are a valuable asset to the habitat and local ecology of the area.

Several significant viewsheds exist along the corridor including views of natural features as well as man-made features such as the airport. The open nature of the corridor allows for significant view distances, and viewsheds should be considered in all phases of design and development for the corridor.

UTILITY SERVICE AREAS

Access to community or public water and sewer service is necessary for large-scale commercial and residential development. Public water is provided to the study area through the Indianapolis Water Company, Brownsburg, and Plainfield. Sewer service in the study area is provided by AquaSource, Plainfield Sewer, and Brownsburg Sewer. The provision of both water and sewer utilities throughout the corridor supports opportunities for large-scale development within the corridor.

Sanitary sewer service availability is one of the most important factors in determining where and when growth and development will occur. Without sanitary sewers, the density of development is restricted because substantial land area is required to support septic systems. In central Indiana, this is especially true, as most of the soils in the area are poorly suited for septic systems. Because much of Hendricks County has soils that do not percolate well, it is not unusual for failing septic systems to cause waste effluent to rise to the surface and create health hazards. In Hendricks County, this has occurred in a number of locations. Septic failures are most noticeable in established areas where homes are placed on small lot parcels and there is inadequate drainage of storm water and ground water. For this reason, residential development should be restricted to lots that have sewer service available to prevent wide spread septic failure.

To help protect community wells from contamination, the U.S. Environmental Protection Agency has mandated that states develop wellhead protection programs. The concept

of wellhead protection involves managing the land uses and contamination sources in the contributing or recharge area for the community well (Marsh, 1998). About 72 percent of Indiana's citizens rely on ground water for drinking water. Indiana's wellhead protection program, required for each well or well field providing ground water to a community public water supply system, (Indiana Wellhead Protection Rule, 327 IAC 8-4.1) is a strategy to protect ground water drinking supplies from pollution that can threaten health, lives, and community development. A community public water supply system is defined as a public water supply system that serves at least fifteen service connections used by year-round residents or regularly services at least twenty-five year round residents. Currently, there are no wellhead protection areas existing within the study area. Therefore, no special provisions regarding land use restrictions prevail at this time.

RESTRICTED LANDS

Several areas within the corridor are restricted for development. These include airport owned lands, areas at interchanges, a tract of land at the CSX railroad, and some agricultural lands that have been previously approved for residential development. These areas pose constraints because decisions regarding their development is in some way or an other "off the table." There are, however, some exciting opportunities that exist within restricted lands. The majority of the restricted lands are airport-owned. **FIGURE 3.9** shows the location of the airport-owned lands. Even though much of the development is to be determined by the airport, discussions regarding their uses are still appropriate, and the County should continue to be involved in the decision-making process for the future of these lands. Several restrictions will determine the future development opportunities for these areas. Some of these areas have been set aside as bat habitats. In addition, building height restrictions within the runway approaches will affect most of the restricted lands on the southeast portion of the corridor. Some opportunities that may be explored include the establishment of open space areas and the preservation of natural features in areas that may be required as bat habitats. Another important opportunity is the use of roadway enhancements and the establishment of gateway features within airport-owned land at the I-70 interchange.

RONALD REAGAN

Corridor Master Plan

FIGURE 3.9: Airport Owned Lands

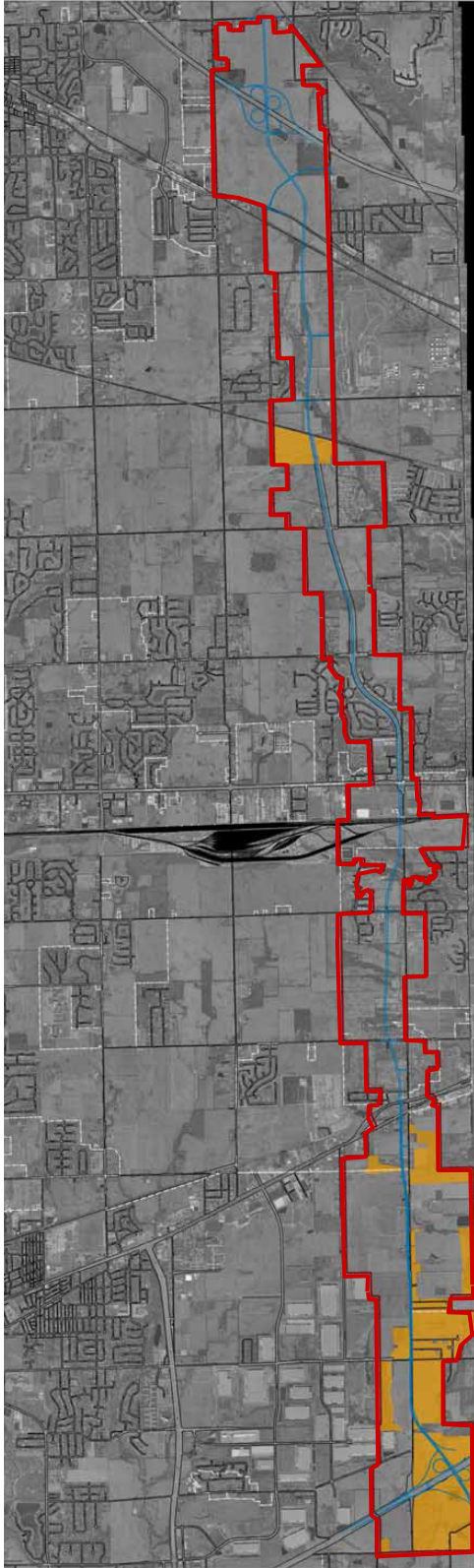

 AIRPORT OWNED LANDS

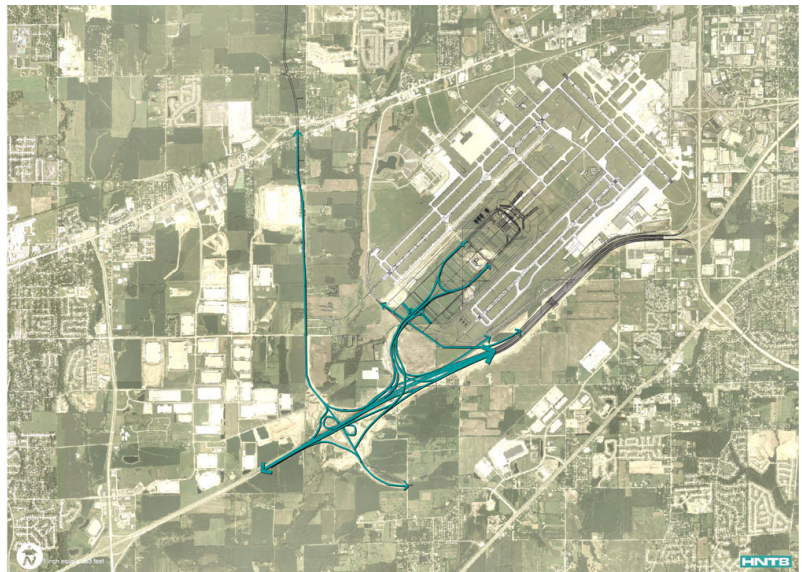

FIGURE 3.10: New Indianapolis International Airport Configuration

EXISTING AND PLANNED TRANSPORTATION IMPROVEMENTS

The Ronald Reagan Parkway will provide key transportation connections for several major transportation systems already in place in Hendricks County. The County is served by surface roadway, rail, air, and pedestrian transportation systems. When completed, the Parkway will serve a role that connects all of these systems and unifies them into a more cohesive and connected system. The surface transportation network contains several significant east-west routes through the County which radiate out from Indianapolis. While east-west routes provide important connections, a lack of north-south routes is a notable detriment in the County. When completed, the Ronald Reagan Parkway will serve as a major north-south connection for these various systems.

Roadways

Two interstates cross the proposed alignment, I-74 on the north side of the county, and I-70 on the south. Both interstates will have interchange connections to the Ronald Reagan Parkway. The I-70 interchange is currently under construction as part of the new interchange to the Indianapolis International Airport. **Figure 3.10** illustrates the new airport and interchange configuration. Federal money has been secured for the design of the I-74 interchange, but no construction funding has been appropriated. Both of these interchanges are key.

US 40 (the National Road), US 36 (Rockville Road), and US 136 also provide significant east-west connections between the County's communities and Indianapolis. All three routes are significant commuter routes, and with increased growth in the County, they are becoming increasingly congested.

The north limit of this study is bounded by CR 600 North (56th Street). Although this roadway doesn't necessarily carry the same traffic volumes as the US routes, it is a significant east-west route in the northern part of the County. Significant residential development in the northern part of the County has increased the need for roadway improvements on 56th Street, and the road is scheduled for upgrade, including additional lanes, in the near future.

Ronald Reagan Parkway

There are portions of the Parkway that have already been constructed. A two lane portion of the roadway has been constructed from CR 200 N to Rockville Road, and serves as a connector between these two roadways. Although only two lanes were constructed, right-of way clearance was secured for the addition of lanes when needed. A second portion under construction is at the south interchange on I-70. The interchange connection will include roadway work and widening north to Stafford Road (CR 450 South).

The next planned phase of the parkway will start at the north end of the completed section at CR 200 North and continue north to CR 300. This portion of the work has been designed and construction will begin in 2004.

There are additional improvements scheduled along the corridor. Federal money has been received for the design of the railroad overpass at US 36, and similar design is scheduled for a railroad overpass and interchange studies at US 136.

Rail

There are currently two main active rail lines that cross the corridor. Both lines are CSX lines. One line parallels US 36 in the central portion of the County, and one parallels US 136 in the northern part of the County. Both carry significant freight. In addition, there is a large CSX rail yard just west of the of the corridor, south of US 36. This railyard creates unique development opportunities, including the potential of use as an inland port.

In addition to freight rail, Hendricks County is also part of the regional study area for Indianapolis' new public transportation system, which potentially could include commuter rail service. Potential service would cross the corridor, and the location at Rockville Road has been designated as a potential terminus for a Hendricks County line.

RONALD REAGAN

Corridor Master Plan

Pedestrian

Several existing and proposed trails intersect the study area. The B&O Rail Trail corridor alignment crosses the Ronald Reagan Parkway in the northern section of the corridor. A pedestrian access tunnel has been planned for the crossing. Several regional trails also are proposed for connection in and near the corridor. These include the proposed Brownsburg Trail, the proposed Avon Creek Trail, the Vandalia Rail-Trail Corridor and the proposed Stafford Road trail in Plainfield. A multi-use path is also located in the Airtech Park campus. In addition, the Indianapolis International Airport is working on plans for the White Lick Creek Trail which will be developed on airport-owned land east of the roadway in the southern part of the corridor. The trail will traverse several specially-designated environmental mitigation areas including passage through protected Indiana Bat habitat.

In addition to its value for vehicular connections, the corridor also provides an abundance of opportunities for creating significant pedestrian and trail linkages.

FIGURE 3.11 illustrates the corridor’s transportation system as discussed above.

EXISTING CONDITIONS CONCLUSIONS

The inventory and analysis provides valuable information that helped the project team to understand the future opportunities and constraints for developing the corridor study area. These opportunities and constraints will become more apparent in the land-planning portions of this master plan, as they are explored in relation to potential future development. Opportunities such as transportation linkages, key regional destinations, natural and historic features, and gateways as addressed in this section provide the basis for many of the decisions that have been made in relation to the future land use plan, corridor enhancement design, and traffic management recommendations.

FIGURE 3.11: Transportation Systems

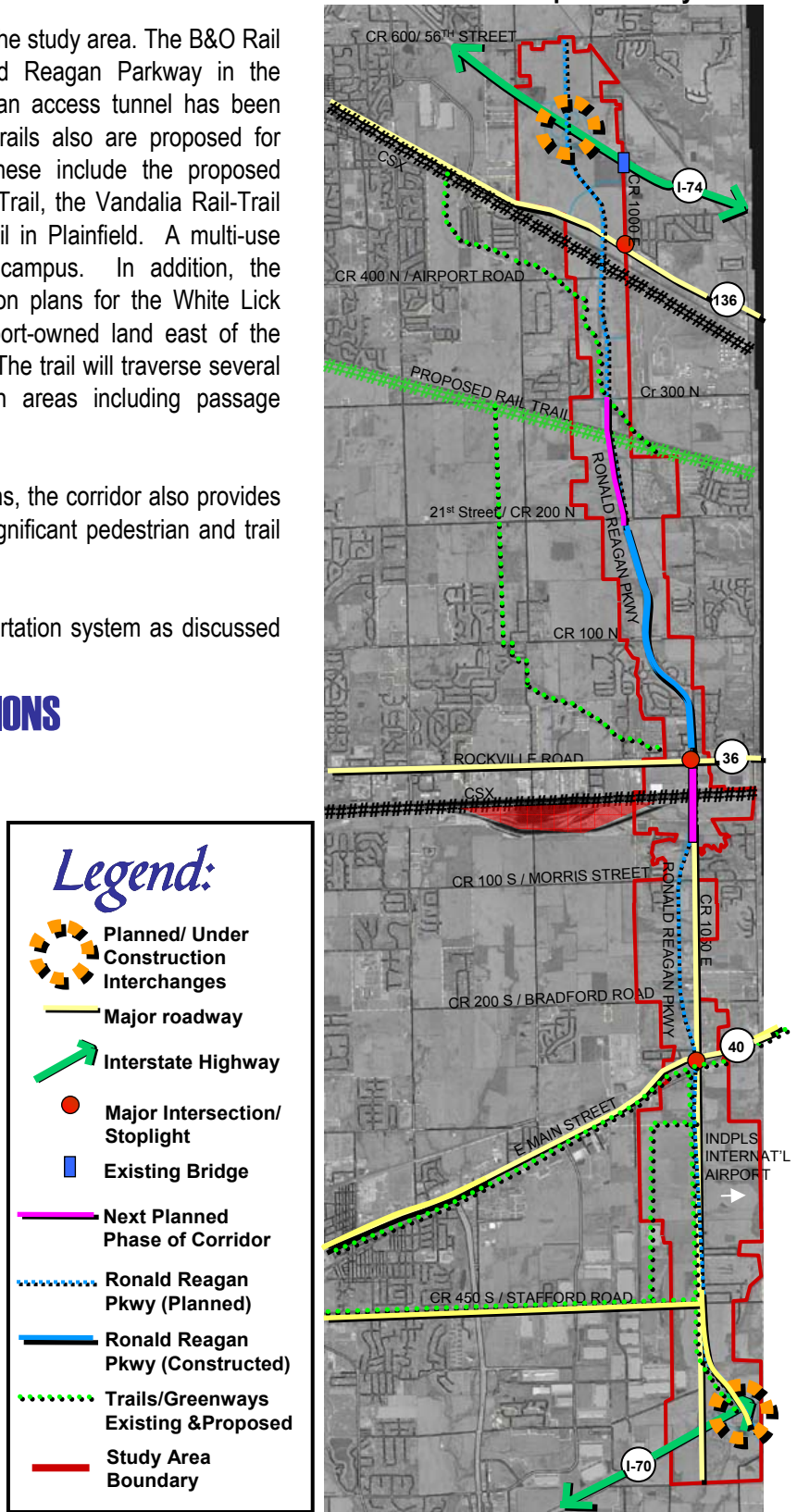

FOUR

Section 4: Planning

**Planning in Hendricks County,
Brownsburg, Avon, and Plainfield**

PLANNING

The establishment of future land use plans and growth management is a major function of the local governments located in the study area. Each local government utilizes its comprehensive plan to help guide their community into the future. The purpose of a comprehensive plan is to outline a community's vision and concepts for specific planning areas through the use of clearly expressed goals, objectives and policies. A comprehensive plan defines a vision for the physical, social, economic growth and redevelopment of a given community. With this being true, the comprehensive plan often influences policy decisions in a broad variety of areas, including land use, transportation and utilities, drainage, environmental conservation, economic development, recreation and open space, and housing. Only with the completion of the comprehensive plan can a community ensure that future growth will provide a higher standard of quality of life for all in the community.

Within the study area, planning activities are occurring at the County and Town level. Hendricks County completed its county comprehensive plan in 1998. The Town of Brownsburg comprehensive plan was completed in 2001, Avon in 1998, and Plainfield is currently developing its comprehensive plan update. Zoning is administered at the county level in the unincorporated areas and each of the local towns administers their own zoning ordinance.

Because of the extent and length of the corridor, it passes through, or adjacent to four different planning jurisdictions. All four have developed land use visions and directions for portions of the corridor, and there are areas of overlap. **FIGURE 4.1** illustrates the political boundaries within and near the study area. The corridor passes through the corporate boundaries of both Plainfield and Avon. Brownsburg's Town limits are located immediately adjacent to the west boundary of the study area. The corridor is located $\frac{1}{2}$ mile from the Hendricks/Marion County Line. In addition, it extends across 3 townships, from Guilford in the South, through Washington, to Lincoln in the North

Given these different planning visions and jurisdictions, the land within the corridor has not necessarily been planned with the whole of the corridor in mind. This has created overlaps in planning, differing land use direction, differing definitions of land uses, and other constraints to a unified corridor development.

For the success of this master plan, it is critical that the individual planning entities support and adopt the preferred corridor land use scenario. In order for that to occur, the plan must recognize the existing planning efforts and visions and build upon those in the final land use plan. The following are brief summaries of the planning done by each community for their portions of land within the corridor.

FIGURE 4.1: Political Boundaries

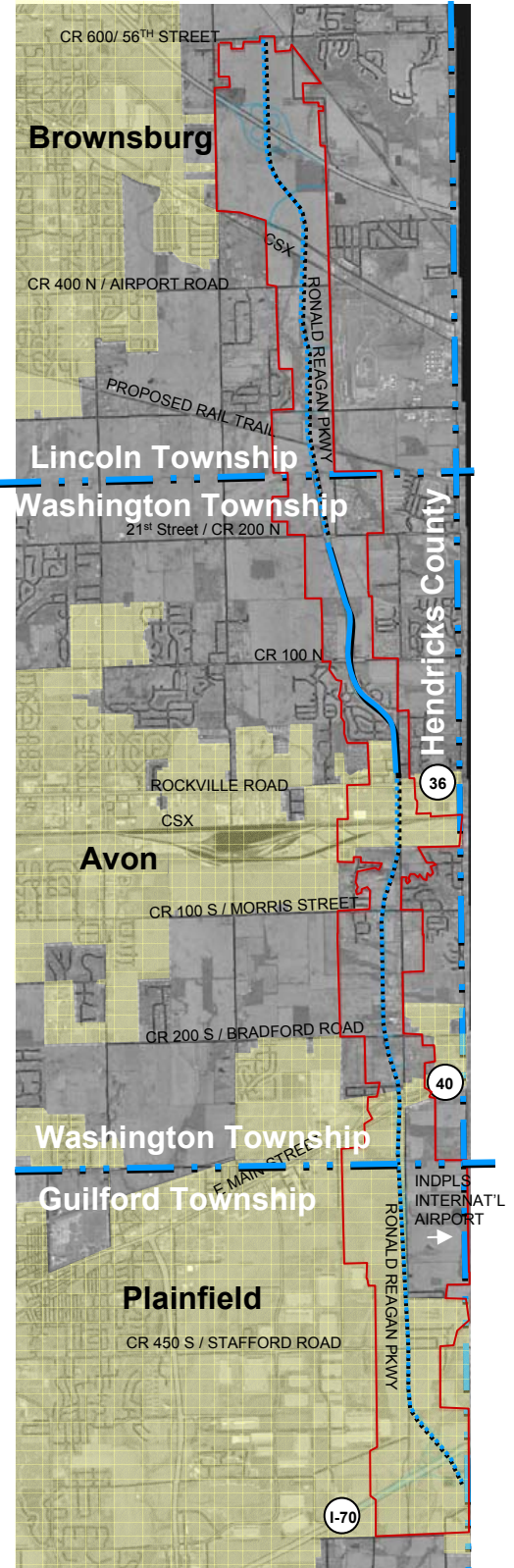

RONALD REAGAN

Corridor Master Plan

FIGURE 4.2: Brownsburg Comp. Plan – Land Uses

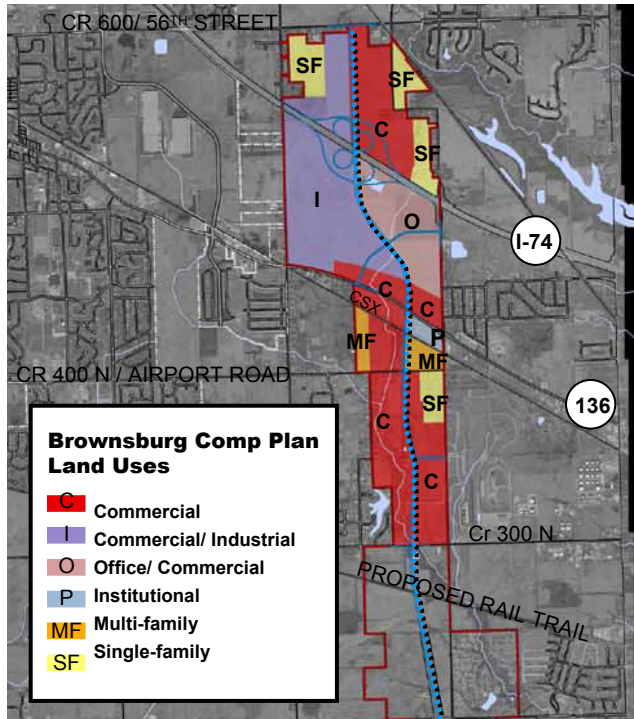

BROWNSBURG COMPREHENSIVE PLAN

The Brownsburg Comprehensive Plan includes land in the northern portions of the study area. The Brownsburg Comprehensive plan calls for mainly a mix of commercial and industrial uses for the portions of land within the study area north of CR 300N. The plan calls for the establishment of a regional and local node with business at the I-74 interchange, and service commercial south of US 136. It also plans for two multi-family residential developments. The portions of the Brownsburg Comprehensive plan affecting areas within the study area limits are shown in **FIGURE 4.2**.

FIGURE 4.3: Avon Comp. Plan – Land Uses

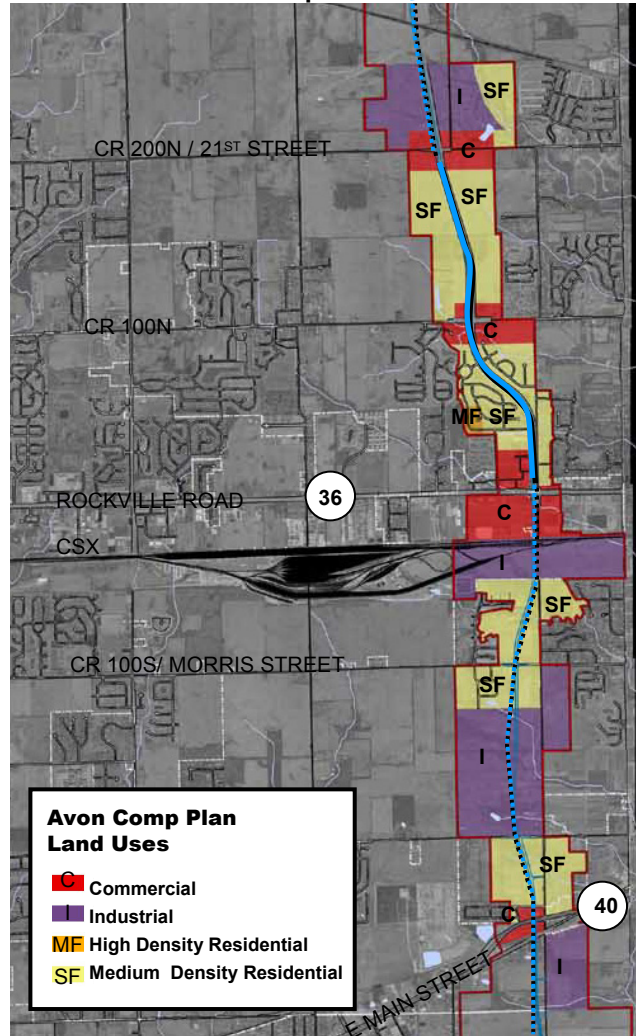

AVON COMPREHENSIVE PLAN

The Avon Comprehensive Plan includes portions of the corridor between CR 300N and US 40. North of US 36 the corridor is designated as residential with an industrial and commercial node at the Lincoln Township Line and a commercial node at CR 100N. South of US 36, the corridor is designated as industrial with existing residential uses. The intersection of US 36 is planned as a commercial area. The portions of the Avon Comprehensive plan affecting areas within the study area limits are shown in **FIGURE 4.3**.

FIGURE 4.4: Plainfield Comp. Plan – Land Uses

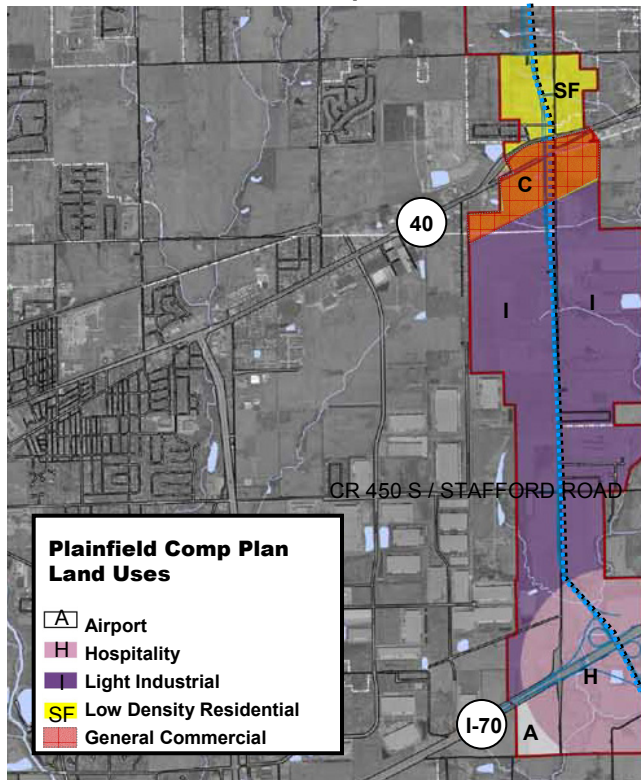

PLAINFIELD COMPREHENSIVE PLAN

The Plainfield Comprehensive Plan affects portions of the corridor south of CR 200S. The plan calls for mainly low general commercial in the areas surrounding US 40. A large area of land is designated for light industrial uses between US 40 and the I-70 Ronald Reagan Interchange. A hospitality node is shown at the I-70 Ronald Reagan interchange and portions of land south of I-70 are also designated as an airport uses study area. These areas are shown in **FIGURE 4.4**.

HENDRICKS COUNTY COMPREHENSIVE PLAN

The Hendricks County Comprehensive Plan illustrates some different land use designations than those seen in the plans of the individual municipalities. The County plan shows most of the corridor as a mix of commercial and light industrial. The entire area North of US 36 and south of CR 200N is shown as medium density residential. The land uses from Hendricks County Comprehensive Plan are illustrated on the following page in **FIGURE 4.5**.

AREAS OF CONFLICT BETWEEN PLANS

There are several areas of conflict between the four plans. The first major difference is that the County classifies most of the corridor as either commercial or industrial. Whereas, in the other plans, there is more of a prevalence of uses such as residential, hospitality, institutional, and office. Each of the local plans are more specific, but some of their uses overlap, and in many cases they do not have jurisdiction of these areas. Overlap occurs in the instance of south Washington Township. Both Avon and Plainfield have included this area as a part of their plans.

The major areas of conflict occur just south of the CSX Railroad tracks and at US 40. South of the tracks, and to the north of Morris Street, Avon has classified this area as residential, whereas Hendricks County has designated it as commercial. In addition, the uses along US 40 have been classified by Plainfield as general commercial, while Avon incorporates them into its industrial designation. These conflicts between the individual plans illustrate the need to coordinate and establish a unified land use plan for the study area of the Ronald Reagan Parkway Master Plan. The areas of conflict are highlighted in **FIGURE 4.5** on the following page.

CONCLUSIONS

There are some differences in the goals and land use designations between municipalities and the resolution of these conflicts is critical to the success of this plan. This corridor master plan was undertaken in cooperation with local municipalities, and discussions were held at steering committee meetings in order to resolve the conflicts that have occurred between these interconnected and overlapping plans. The final land use scenario that will be discussed in Section Five was established in cooperation with representatives from these governing bodies, and is meant to resolve the differences between these comprehensive plans for the areas within the corridor study area. The preferred land use scenario that was developed is recommended as the unifying plan between each individual comprehensive plan. This plan encourages the Hendricks County Commissioners and the Brownsburg, Avon, and Plainfield Town Councils to adopt the Ronald Reagan Corridor Master Plan as the prevailing land use plan for development within the limits of the corridor. An overlay district will be recommended in order to realize development objectives without modifying the objectives/standards of the underlying existing zoning ordinance.

FIGURE 4.5: Hendricks County Comp. Plan – Land Uses

Legend:

County Comp Plan Land Uses

- C/I Commercial/ Light Industrial
- R2 Medium Density Residential
- R1 Low Density Residential
- INC Incorporated
- Areas of Conflict

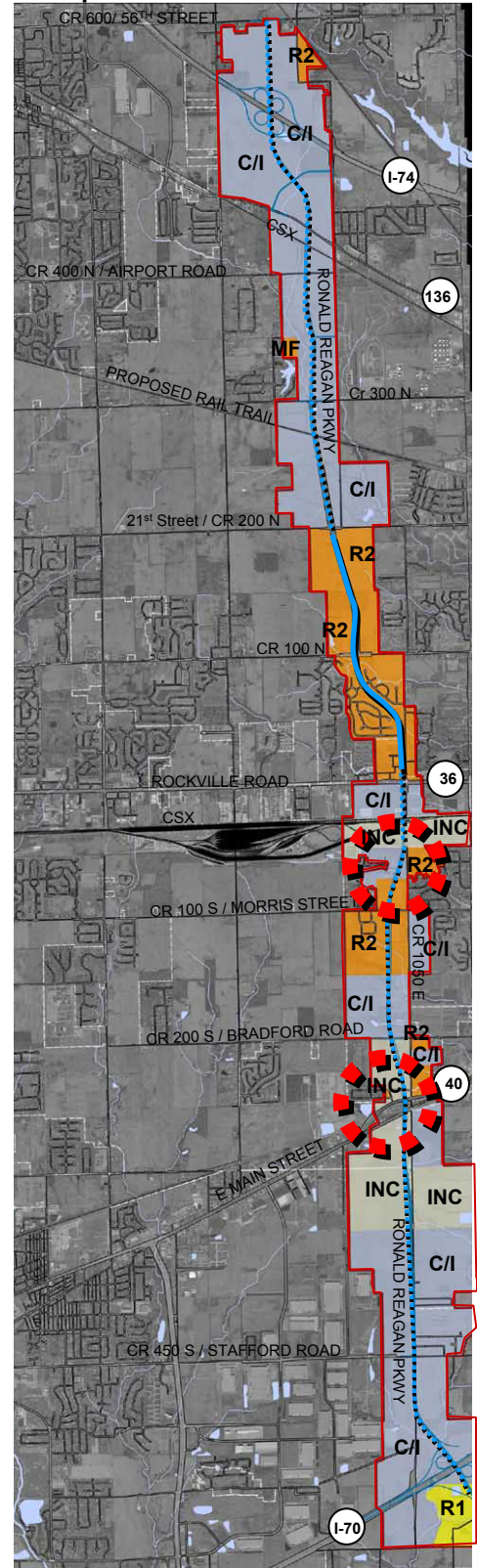

FIVE

Section 5: Land Use Plan

**Development of a Preferred Land Use Scenario
for the Ronald Reagan Corridor Master Plan**

RECENT TRENDS AND MARKET CONDITIONS

The past decade has shown exploding population growth throughout Hendricks County. The regional growth from Marion County towards the Hendricks County line is shown in **FIGURE 5.1** below. The number of building permits issued County-wide has grown by nearly 190% since the early 1990's, and some local municipalities are exhibiting even higher development rates. With this expansion of residential development has come an increase in the number of retail centers, restaurants, doctor's offices, and to a lesser extent, industrial development. Much of the latter has occurred in Plainfield which has experienced significant industrial growth and development in the form of bulk warehousing and distribution.

FIGURE 5.1: MSA Urbanization Trends

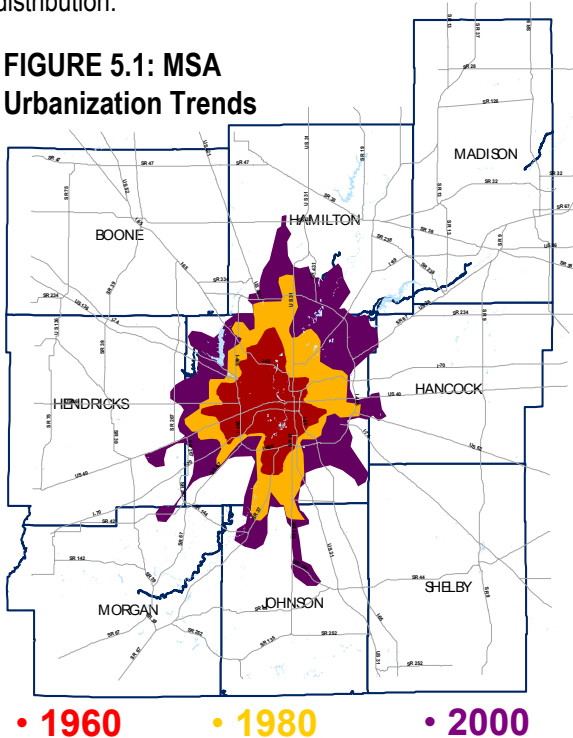

Understanding the current development patterns and local market conditions was an important component in planning for future growth in the Ronald Reagan Corridor study area. The trends and tendencies of the current market indicate which uses are likely to develop in the area with little or no outside influence. They also help decision makers to identify land uses which, if desired, may require a more aggressive economic development approach, such as financial incentives. **FIGURE 5.3** on page 5-4 illustrates an evaluation matrix utilized to analyze the market conditions in the corridor. Development trends for the regional market were analyzed, and applied to the corridor in order to identify opportunities for growth and to help guide the establishment of the land use scenarios developed as part of this master plan. The following summarizes the current market conditions for the four major development types occurring in the area.

Residential Market

The population increases throughout the County reveal a strong residential market in Hendricks County. In fact, in 2003, Hendricks County had the second highest percentage increase in home sales and the third highest increase in number of homes sold in the Indianapolis region (Colliers Turley Martin Tucker). The increase in home sales throughout the region has been fueled by a forty-year low in mortgage rates. Conversely, the availability of low interest rates has slowed multi-family development across the Indianapolis region. Townhouses, condos, and doubles are also still popular home ownership options. Without policy intervention, it is likely that the corridor would continue to develop as predominantly residential with economic development characterized by bulk warehousing and distribution and some retail.

FIGURE 5.2: Hendricks County Residential Building Permits

Hendricks County Residential Building Permits (1990-2002)													
	1990	1991	1992	1993	1994	1995	1996	1997	1998	1999	2000	2001	2002
Permits Issued	660	720	1118	960	1123	1493	1524	1513	2383	1891	1901	2383	2928

Source: US Census Bureau Building Permits Survey

Retail Market

The retail market is dependent on the residential market, because the number of homes in the area supply the retail uses with their customer base. Retail is also location driven and tends to locate along major transportation arterials. The retail market across Hendricks County has been strong, with the most significant growth attracted to major corridors such as the I-74 and I-70 exits, US 36, US 40, US 136 and State Road 267. The local communities across the County have welcomed retail development as a positive property tax generator to offset some of the costs of residential development. However, retail development does bring with it high impacts on the amount of traffic along the commercial corridors. While retail land uses do generate an average of one job per 250 square feet of retail space, these jobs tend to be lower paying than office and industrial jobs (Urban Land Institute).

Office Market

Office development is eagerly sought by many suburban communities. It is a positive tax generator, provides high paying jobs at a rate of one job per 300 square feet of office space (Urban Land Institute), and has less of an impact on the community's roadways than retail and industrial development. However, office development is often the most difficult to attract. Unlike retail uses, which demand only rooftops, office developers are enticed by an area's amenities. A high quality of life offering employees good schools, recreational areas, high quality restaurants and entertainment, and a range of housing options is a very important consideration. Office developers also look for areas with the labor pool that they need and areas which have an aesthetic quality and recognizable address that will promote and enhance the image of their company.

Unfortunately, the suburban office market in the Indianapolis region has been weakening over the past eight years, resulting in a 23% vacancy rate in 2003. Colliers Turley Martin Tucker anticipates an eventual increase in the office market, but until new jobs are created, the market will remain weak. The exception is the medical office sector which has shown some growth around new hospital locations. This is welcome news for Hendricks County which is awaiting the opening of Clarian West on the Ronald Reagan Parkway.

Industrial Market

The industrial market is broad, including uses such as manufacturing, fabrication, assembly, packaging, warehousing, and distribution, to name a few. The range of uses in the industrial category may impact communities significantly.

Light industrial uses and flex-tenant spaces are driven by the availability of the local workforce, transportation systems, and the location of the users of their products. They provide positive tax benefits to a community and provide medium to high paying jobs at a rate of one job per 1000 square feet of industrial space (Urban Land Institute). The current market for these types of uses is relatively flat, meaning growth and the development of new space is slow (Colliers Turley Martin Tucker).

The character of industrial uses in the Indianapolis region is not smaller industrial land uses, but bulk distribution and warehousing. This trend has been most prevalent in Plainfield, although it is also evident in Brownsburg near I-74. In the Avon area, interest is growing for bulk warehouse and distribution uses. Bulk warehousing and distribution is driven by its demand to be located along a regional transportation system, usually an interstate highway. While these uses generate heavy volumes of truck traffic, they are often discouraged by a community's traffic problems. Bulk warehousing and distribution uses provide positive tax benefits for a community and jobs at an average of one employee per 2000 square feet of space. However, bulk warehousing and distribution jobs are generally lower paying (Urban Land Institute).

The Indianapolis regional market for these uses is very strong. Colliers reported earlier this year that an additional 2.3 million square feet of new construction was added to the market in 2003, and that an additional 2.7 million square feet was already planned for 2004. Plainfield and Brownsburg are among the leaders in the Indianapolis area for new bulk warehousing and distribution space.

FIGURE 5.3: Current Market Conditions Evaluation Matrix

Land Use	Property Tax Revenue per Acre	Avg. acres.	Jobs Created	Pay Scale	Market Conditions
Single Family	\$8,900	.1 ac.+	--	--	good
Multi Family	\$14,500	4 ac.+	--	--	fair
Commercial/Hospitality	\$12,500	5 ac.+	4/1000 s.f.	low	good
Office/Medical	\$16,300	5 ac.+	3.33/1000 s.f.	Med. - high	poor
Light Industrial	\$14,600	25 ac.+	1/1000 s.f.	Med. - high	fair
Warehouse/Distribution	\$10,000	50 ac.+	1/2000 s.f.	low	good
Flex Tenant	\$11,500	10 ac.+	1/1000 s.f.	Med. - high	fair

The table in **FIGURE 5.3** above is a summary of the existing market conditions in the corridor.

RECENT DEVELOPMENT TRENDS – PROXIMATE TO CORRIDOR

As discussed in several previous sections, Hendricks County continues to see elevated levels of growth. **FIGURE 5.4** summarizes the recent development trends proximate to the corridor that has occurred between 1993 and 2003. There are numerous single-family residential developments occurring in and around the corridor as a result of the growth developing from the east in Marion County as well as from increases in population. Current economic forces are driving the development of residential communities surrounding Marion County, and Hendricks County is no exception to this rule. Residential development supported by commercial areas are likely to continue to occur along the corridor unless the County intervenes to control the types of development that develop along the corridor. It is important to understand these market forces in order to accomplish the goal of the master plan. If market forces are left to prevail, the development of an economic development corridor would be highly unlikely. Rather, the corridor would likely become a residential collector that is fed by commercial nodes. Therefore, it is necessary for the local governments to implement a land use plan that supports the economic goal of establishing a premier economic address. The land use planning exercise that was undertaken for the parkway considers the various means for accomplishing this goal. Alternative scenarios were considered and discussed in detail before developing a final recommended solution. The objectives set forth in the land use plan, its implications for the corridor, and the means for implementing the land use plan will be discussed in the sections that follow.

RONALD REAGAN

Corridor Master Plan

FIGURE 5.4: Development since 1993

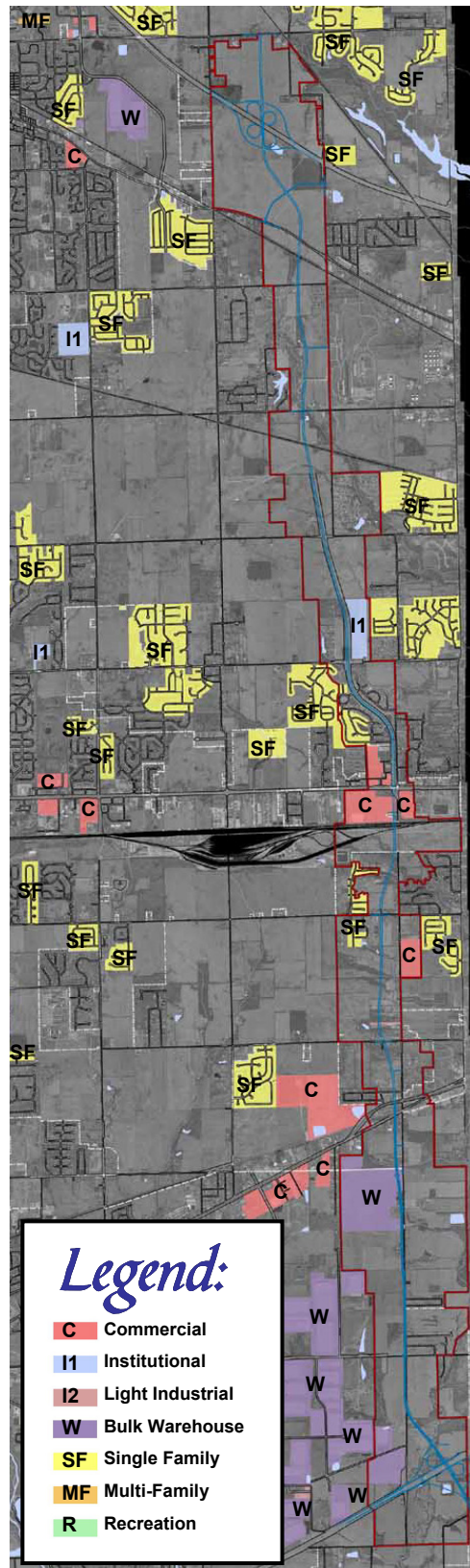

DEFINITIONS

Land use designations such as “commercial”, “industrial”, and “residential” can oftentimes be somewhat vague. Each reader may interpret differently which specific uses fall into each category. The following definitions should be used in reading and implementing the land use plan that follows.

Light Industrial:

Manufacturing and/or processing, fabrication, assembly, packaging, incidental storage, sales, and distribution of products or parts made from previously prepared materials (i.e. cloth, plastic, paper, metal, wood); the operation of which occurs within buildings, does not require exterior storage, does not generate significant amounts of truck or rail traffic, and is free of hazardous or objectionable elements such as noise, odor, dust, smoke, glare or other pollutants. For the purpose of this plan, warehousing and distribution uses which have a floor area of 100,000 square feet or greater shall not be considered “light industrial” but shall be defined as “bulk warehousing/distribution.”

Heavy Industrial:

Manufacturing or processing of products from large, bulky, predominately raw, extracted or hazardous materials; or a use engaged in the storage of flammable, explosive or other materials that may pose a threat to public health or safety. The operation of heavy industrial land uses may require exterior storage, be engaged in outside processing or assembly, generate significant amounts of truck and/or rail traffic or emit limited amounts of objectionable elements such as noise, odor, dust, smoke, glare or other pollutants.

Commercial/Retail:

For the purpose of this plan, a retail or commercial establishment is a business having as its primary function the supply of merchandise or wares to the end consumer. Retail establishments are places where goods, wares, merchandise, substances, articles, or things are offered or kept for sale at retail, including storage of limited quantities of such goods sufficient only to service such store.



FIGURE 5.5: *Flex tenant space permits a variety of uses in a setting that is more compatible with residential and office development than other industrial uses.*

Flex Tenant:

A building designed for multiple tenants, where office space is located at the front of the building with warehouse space, typically accessed by delivery doors, at the rear elevation of the building. The proportion of office vs. warehouse space in each tenant space is not determined until the user occupies the space, and the space may be subsequently re-proportioned to accommodate a new occupant or the current occupant’s changing needs. Flex tenant space may include such uses as offices, retail and wholesale stores, warehousing, manufacturing, light industrial, or scientific research functions.

Bulk Warehousing and Distribution:

Bulk warehousing and Distribution are classified as structures that are used primarily for the receipt, temporary storage, possible modification/customization, and distribution of goods that are en route from production sites to where they are consumed. For the purpose of this plan, warehousing and distribution uses which have a floor area of less than 100,000 square feet may also be classified as “light industrial”.

Office Space Classes:

Office space is classified as Class A, Class B or Class C space based on location, the building’s condition, and tenant amenities, with Class A being the highest quality space. Class A offices are offices that have excellent location and access, attract high quality tenants, and are managed professionally. Class A offices generally offer amenities to their tenants such as a fitness center, bank, or similar uses. Class B office space provides fewer amenities, is not as well located, and/or may not be professionally managed. Class C office spaces are discouraged.

LAND USE SCENARIOS

Planning for future land uses within the Ronald Reagan Corridor study area involved a compromise between current market trends and a desired goal for the overall aesthetic look and economic impacts of the corridor. Prior to determining the layout of future land uses within the study area, the steering committee participated in an exercise to determine consensus on various land use types and their appropriateness for the corridor. The result was a group of land uses that were deemed desirable along the Ronald Reagan Parkway. These included flex-tenant space, light industrial, hospitality, retail, and medical offices. The steering committee also determined it did not wish to see single family residential development within the study area, but preferred to reserve the corridor for economic development.

The desirability of bulk warehousing and distribution, multi-family residential, and professional offices land uses was less clear. While bulk warehousing and distribution provides the tax base desired, the committee worried that the aesthetic impact on the parkway would be negative. Multi-family development could serve as a buffer between new commercial and industrial development and existing single family development. However, multi-family land uses in these areas would also monopolize land which could not then be used for economic development purposes.

Finally, while the benefits of office development are desirable, the cost of subsidizing office development could be significant, or the development may never occur. However, medical-related office uses are welcomed as a positive opportunity if located adjacent to Clarian West.

To lay out placement for the consensus land uses and to come to agreement on those uses where no consensus had been found, three different alternative development patterns were developed for the study area, each requiring varying degrees of market intervention.

The project team presented each of the three scenarios to the steering committee. These scenarios were utilized to initiate dialogue, and to help form the basis for a preferred land use scenario.

The first alternative, the “true market scenario” examined past market trends in immediate proximity to the study area and assumed a continuation of those trends, without government intervention through land planning, zoning, or economic development strategies. The “modified market” scenario (Alternative #1) removed single family residential from the scenario, resulting in more land area for economic development uses which are driven by the current market.

FIGURE 5.6: Land Use Alternative Scenarios

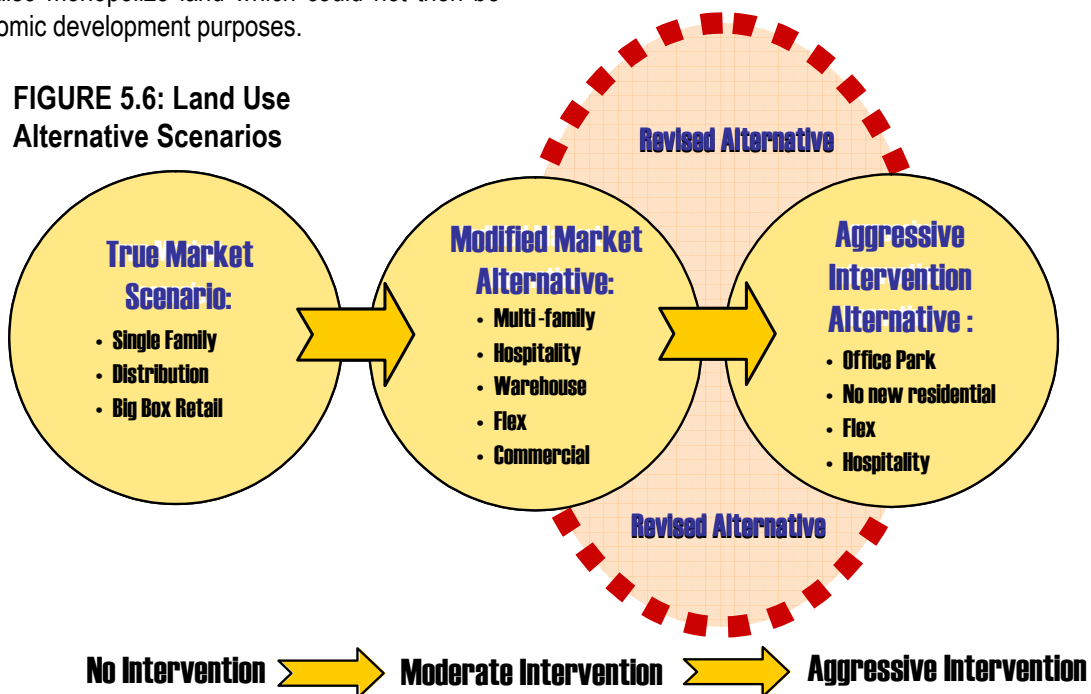

The “aggressive intervention” scenario (Alternative #2) introduced professional offices as a possible land use, assuming the use of further government intervention. This scenario also prohibited new development of multi-family and single family housing, bulk warehousing and distribution. Based on the dialogue that was initiated, a final preferred land use scenario was established which illustrates a final vision for the future development of the corridor. **FIGURE 5.6** to the left summarizes the three market scenarios, and the process that led to the creation of the final preferred land use scenario. A detailed summary of the three initial scenarios is as follows.

TRUE MARKET SCENARIO

To determine the likely build out of market trends in the study area, new development over the past decade within approximately 3 miles of the study area was mapped using a time series of aerial photography. The results showed

that nearly half (49%) of all new development (in acres) near the corridor in the past ten years had been single family residential. Another 30% of new development was bulk warehousing and distribution, followed by commercial uses (13%), institutional uses such as churches and schools (4%), multi-family (2%), and light industrial and recreation (each 1%). A pie graph of these trends is shown in **FIGURE 5.7**.

Looking specifically at the Corridor study area, the same trend was exhibited, though slightly distorted towards the institutional uses as a result of the fifty acres being developed by Clarian Hospital. Therefore, the County can expect that if there is no intervention of land use policy or zoning, the corridor study area will develop along the same trends as the rest of eastern Hendricks County, primarily residential with economic development largely characterized as bulk warehousing and distribution as well as retail. As this outcome is not the desire of the County, two alternative land use development scenarios were presented that focused on using land use policies and zoning to influence development trends.

**FIGURE 5.7: Development Trends 1993-2003
Proximate to Corridor Area**

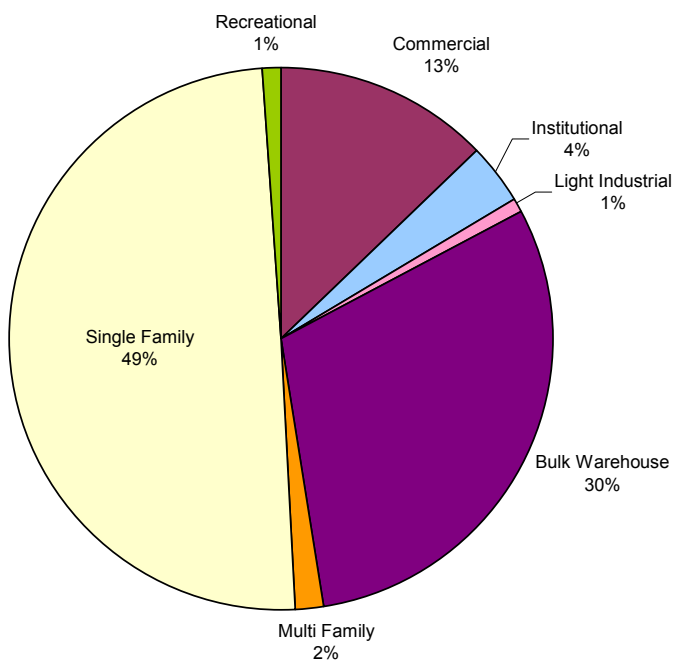

ALTERNATIVE DEVELOPMENT SCENARIO #1: MODIFIED MARKET ALTERNATIVE

The primary market intervention in Alternative #1 was the restriction of all new single family housing in the study area. Multi-family housing was still permitted in this scenario and was proposed as a buffer from commercial and industrial uses in areas where there is already a significant single family residential presence. Thus, multi-family uses were located on the east side of the Parkway alignment, generally between US 40 in Plainfield and the CSX rail yards in Avon.

Retail uses will naturally be drawn to the corridor, and Alternative #1 allowed for concentrations of retail development at the Parkway’s intersections with US 40, US 36, US 136, and CR 100N near Clarian West. Retail development was also shown around the I-74 interchange. For the I-70 interchange, rather than showing an all inclusive “retail” land use category, Alternative #1 reserved this land for “hospitality” uses – generally hotels and restaurants which would be attracted to the close proximity of the airport.

While some of this land is owned by the airport, much of the airport-owned land in Alternative #1 was classified only as “airport uses”, leaving the final designation of use to the discretion of the airport.

The remainder of undeveloped land in the study area was identified for industrial uses. Land was reserved adjacent to Airtech park in Plainfield and Eagle Point in Brownsburg for the expansion of bulk warehousing and distribution uses. Land between US 40 and the CSX rail yards in Avon was designated for flex-tenant space. The land between US 136 and midway between County Roads 300 N and 200 N was also designated by Alternative #1 as flex-tenant space to accommodate the light industrial and commercial uses associated with Indianapolis Raceway Park. The area immediately adjacent to the CSX rail yards was proposed for light industrial in order to take advantage of the potential for rail transport of goods. This site is one of the few remaining rail accessible sites in the Indianapolis area, and therefore should be developed for industrial uses that will benefit from rail access.

ALTERNATIVE DEVELOPMENT SCENARIO #2: AGGRESSIVE INTERVENTION

Alternative #2 further modified market trends by restricting both single family and multi-family residential, restricting bulk warehousing and distribution, limiting retail north and south along the Parkway, and introducing professional office uses.

In Alternative #2, the interchanges of both I-70 and I-74 were dedicated to hospitality uses – hotels and restaurants in the north to serve Indianapolis Raceway Park (IRP) related tourism, and hotels and restaurants in the south to cater to the Indianapolis International airport. Retail-oriented commercial was limited to the Parkway’s intersections with US 136, US 36, and US 40 and did not expand far north or south of the intersections. The intent was for retail to concentrate on cross streets where more access could be provided, rather than along the Parkway which will have limited access.

Alternative #2 introduced an area for professional offices north of the Clarian hospital, between the hospital and CR 300 N on either side of the Parkway. While the overall market for office space is poor, the corridor has a market opportunity for medical-related office facilities adjacent to Clarian West. The decision to incorporate office space was made in order to promote a long-term vision for the corridor. Medical-related office uses would be a positive tax generator, providing high paying jobs. In addition, this area designated for office would be more compatible with the nearby public and residential uses than other types of uses such as industrial or commercial.

Like Alternative #1, the remainder of undeveloped land in the study area was designated for industrial uses. However, unlike Alternative #1, these uses did not include bulk warehousing and distribution. The land adjacent to IRP between US 136 and CR 300 N, the east side of the Parkway between the CSX rail yards and CR 200 S, and US 40 to the I-70 interchange were all designated for flex-tenant space. Flex-tenant uses will provide more visually appealing “storefronts” or “office-fronts” on warehousing or light manufacturing spaces.

Flex-tenant space permits a variety of uses in a setting that is more compatible with nearby residential development than other industrial uses.

Finally, the property south of the CSX rail yards in Avon and between CR 100 S and CR 200 S on the west side of the Parkway in Avon were designated as light industrial.

FIGURES 5.7 and 5.8 on the following page illustrate Alternative Development Scenarios #1 and #2. The legend on the following page depicts the land uses along the corridor and corresponds to the alternative development scenarios and the preferred land use scenario on the pages that follow. Land uses are color coded and identified with letters on each map.

FIGURE 5.8: Scenario #1

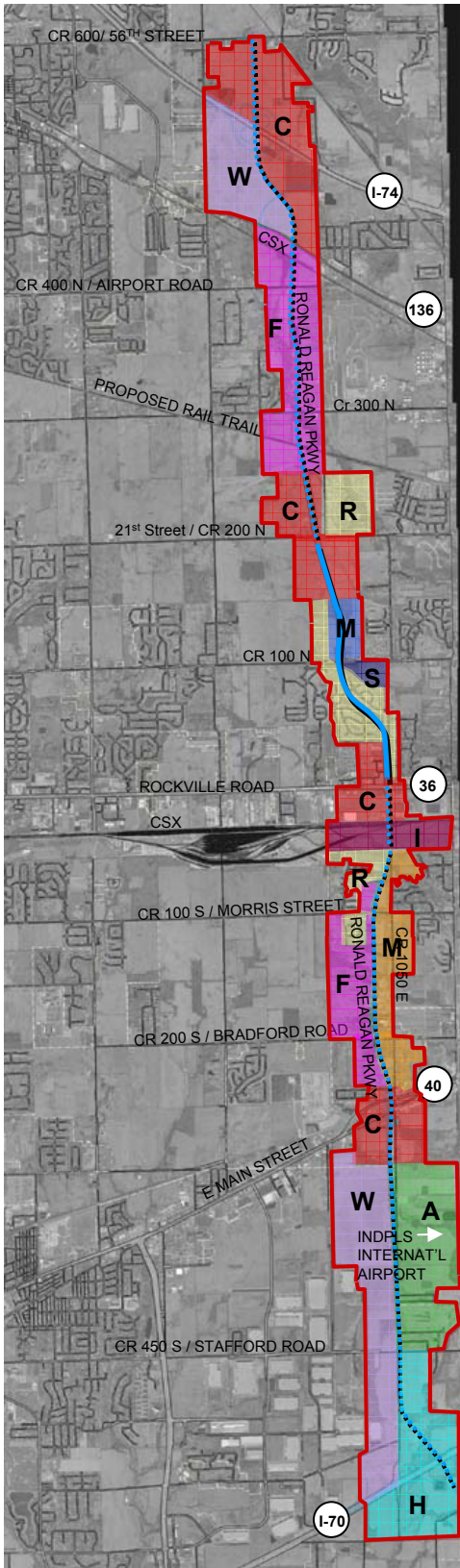
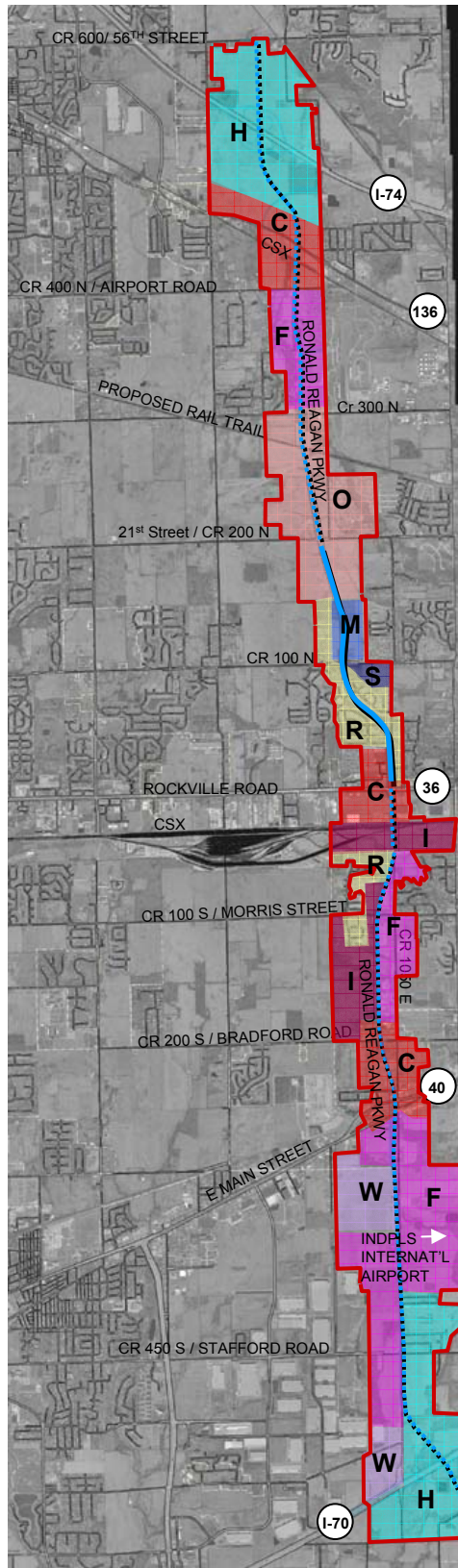

FIGURE 5.9: Scenario #2



Land Uses:

C	Commercial
W	Warehouse
O	Office
R	Single-family
M	Medical
S	School
I	Lt. Industrial
F	Flex
A	Airport Uses
M	Multi-Family
H	Hospitality

PREFERRED LAND USE SCENARIO

The final land use plan for the Ronald Reagan corridor utilizes some components of each of the various alternative development scenarios presented. During the creation of the preferred scenario, the local market was weighed against the goals of the County for economic development and the aesthetic character of the parkway. The alternative development scenarios were utilized in an exercise with the steering committee to invoke discussion and to provide a decision-making platform to establish the preferred land uses and characteristics that should be implemented in the final development scenario. Components of each scenario were discussed, and the result of this exercise was the development of the final scenario with consensus of the committee. The preferred land use scenario illustrated in **FIGURE 5.10** illustrates the outcome of this exercise and the final land use decisions made by the committee. The result is a land use plan that restricts residential development to areas in which it already exists, locates commercial development in concentrated nodes, emphasizes the need for hospitality uses in connection with local tourism and the airport, reserves land for professional office development, and provides land for a wide variety of industrial uses, including bulk warehousing and distribution. The preferred land use scenario is illustrated in **FIGURE 5.10** to the right, and larger scaled maps are illustrated in **FIGURE 5.11**, **FIGURE 5.12**, and **FIGURE 5.13**. Each land use is described below in the sections to follow.

Residential Land Use

The final land use plan restricts new residential development within the corridor study area. Existing neighborhoods under development will be permitted to continue to build out, but no new residential developments, whether single or multi-family, should be created. The land use plan for the corridor is intended to develop the land along the parkway for the purpose of economic development. Residential development would not only consume valuable commercial and industrially suited land, it would create new areas of conflict between residential and non-residential land uses.

FIGURE 5.10: Preferred Land Use Scenario

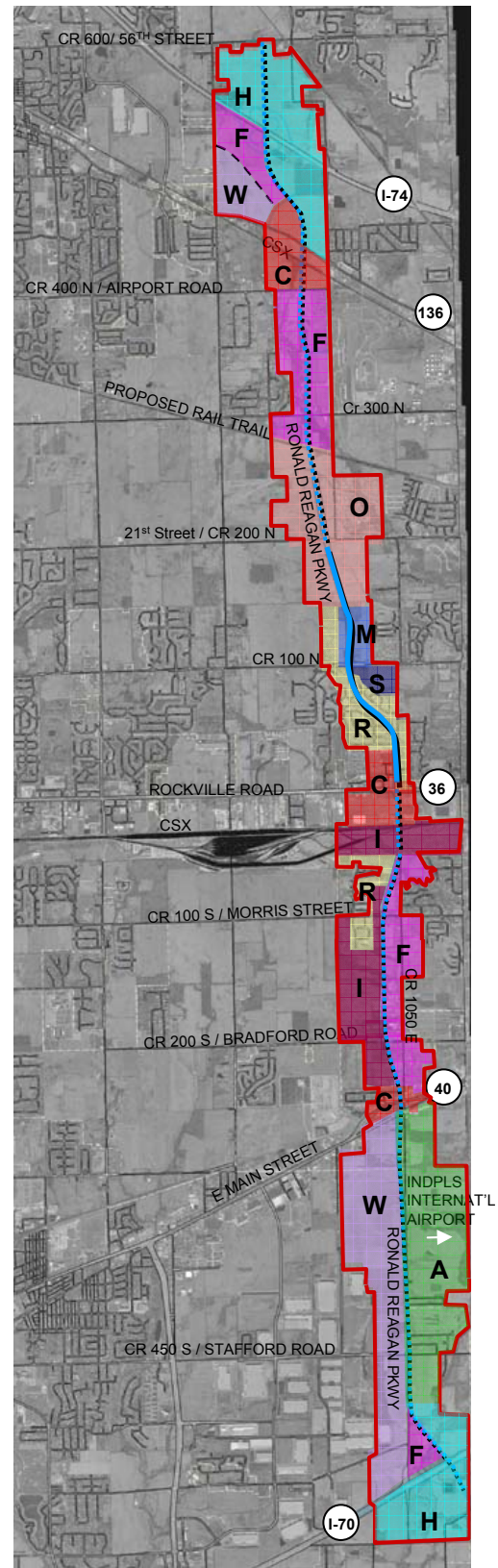

FIGURE 5.11: Preferred Land Use Scenario- North

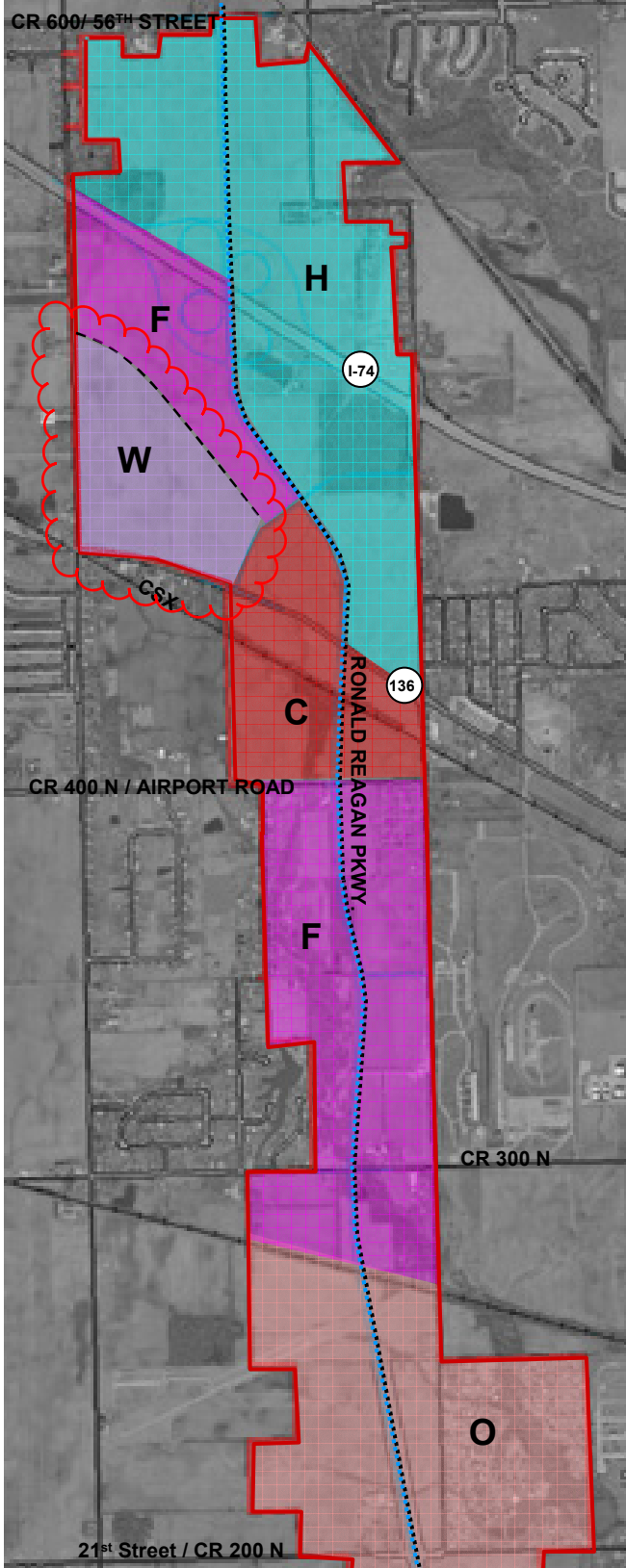

FIGURE 5.12: Preferred Land Use Scenario- Center

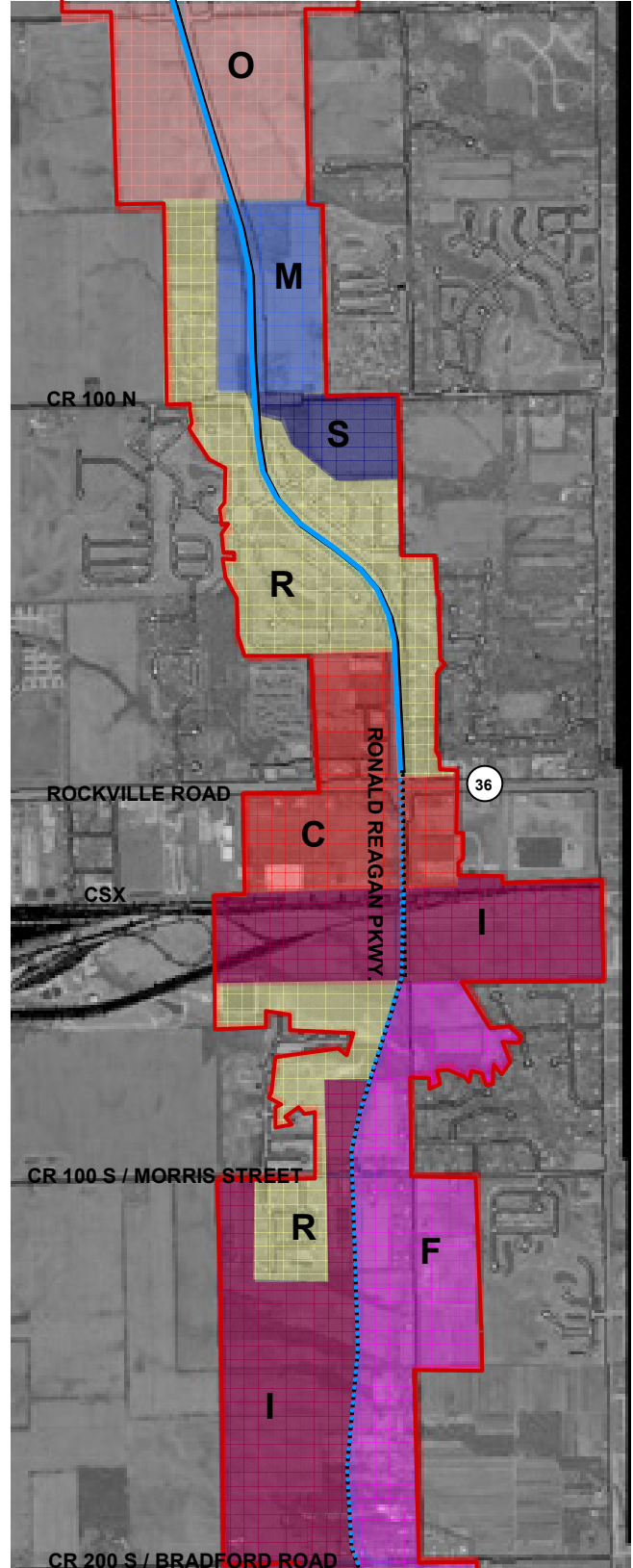
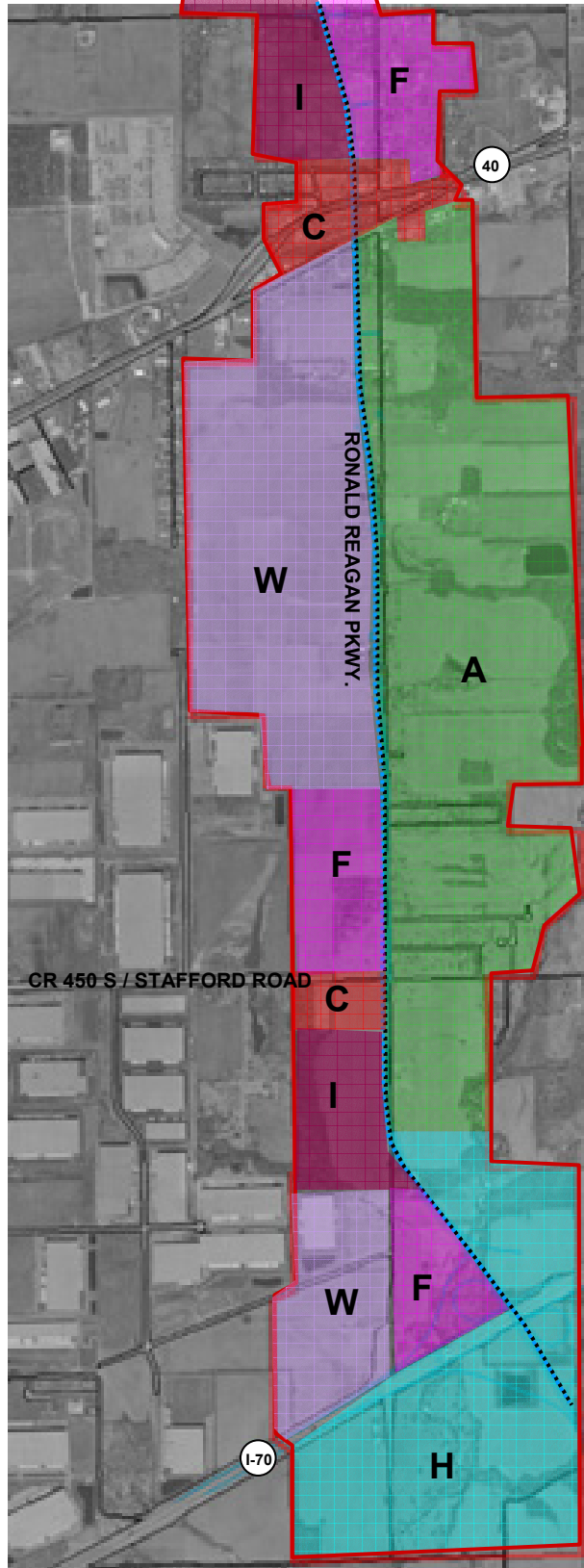

FIGURE 5.13: Preferred Land Use Scenario- South



Retail Land Use

Major transportation thoroughfares are attractive locations for retail development. They provide high visibility and high accessibility for customers. However, the traffic generated by retail development can quickly change the character of a roadway by slowing traffic with frequent curb cuts. The final land use plan recognizes that retail development will naturally be attracted to the Ronald Reagan Parkway. Therefore land is allocated for retail development at major intersections, including the intersections of Ronald Reagan Parkway and US 136, US 36, and US 40. A total of 335 acres are allotted for commercial uses, approximately 7.5% of the study area. Many of these intersections already have retail development. While these uses will be encouraged to continue and to redevelop as needed, retail development should be limited to the areas designated by the plan and is discouraged to develop in a north-south fashion along the corridor. It is the intent of the final land use plan to create commercial nodes which can provide a concentrated access point for vehicular traffic and to minimize the number of curb cuts located on the Parkway. These nodes would therefore have internal circulation systems to distribute traffic to the various individual properties. As a result, there will be much less demand from development to create access points from the Parkway, resulting in fewer turns, fewer stops, and generally better mobility along the Parkway itself.

Hospitality Land Use

Hospitality uses are generally described as land uses which cater to visitors. The alignment of the Ronald Reagan Parkway provides access to both the Indianapolis International Airport and Indianapolis Raceway Park, both of which will attract large numbers of visitors to the area. The intersection of the Parkway with I-70 will be a natural location for hotels to service the airport once the airport's orientation changes towards Hendricks County. Hindering the development of this area are restrictions on building heights within the runway approaches, and several environmentally protected areas. Development in this area must therefore adapt to those conditions. While high-rise hotels may not be an option, smaller hotel facilities, restaurants, and other retail uses are well suited for this area.

Similarly, the Parkway's interchange with I-74 provides opportunities for tourist oriented uses such as hotels, restaurants, and retail. Indianapolis Raceway Park (IRP) is located just south of the interstate interchange at CR 1050 and US 136. Demand for hotels in the Brownsburg area has grown, and the I-74/Ronald Reagan Parkway interchange will provide convenient access to the racetrack as well as the high visibility hotel developers demand. With the location of hotel development will come increased demand for retail and restaurant uses to serve the needs of visitors. These too are encouraged to develop around the interchange and as far south as US 136. A total of 833 acres has been designated for hospitality uses. This is approximately 18.6% of the corridor study area.

Like retail land uses, hospitality uses can result in increased traffic congestion if the number of curb cuts onto the parkway is not limited. Interstate interchanges are especially important to economic development along the parkway, as they provide access for residents and the rest of the County for the transfer of goods and services. Accessibility to the interchanges and mobility along the parkway must remain a high priority. Therefore, like retail uses, hospitality uses must be limited in their number of curb cuts and instead use internal road networks to access individual properties. Restrictions on access will be further discussed in Section 7 of this report.

Office Land Use

While the market for the development of suburban office space has been slow in the Indianapolis area, the steering committee determined the need to set aside a portion of the corridor for office development. The steering committee recognized that the development of office space in Hendricks County may take time, but determined that the potential benefits for the County will exceed the drawbacks of waiting for development to occur. Because medical related office uses are the strongest market segment at this time, and because the area is within close proximity of a strong retail center, the area surrounding the new Clarian West Hospital was selected for the development of professional office space. This area extends north from the hospital site on both sides of the parkway to the former B&O rail line. Five hundred and four acres have been set aside for office land uses, approximately 11.2% of the corridor study area.

While the office park area is designated for office uses, other uses which are compatible with an office park environment may also be supported in this location. Offices generally attract and are attracted to areas which offer services to employees such as restaurants, personal services, and convenience type retail. However, care should be taken to avoid allowing commercial uses to consume large quantities of land. Development pressures for commercial will likely occur before office development locates in this area, requiring dedication from the Town of Avon and Hendricks County to reserve the area for office space.

It should be noted that this area is discussed in the Town of Avon Vision Plan. The vision plan refers to the area as part of its "health park/sports/education activity center". The plan discourages this type of outdoor recreation use to develop immediately adjacent to the Parkway due to the amount of vehicular traffic, including a large volume of truck traffic. However, the location of a fitness center, YMCA or other indoor sports facility could be compatible and very beneficial to the development of office related uses. Should the Town develop this section of the corridor for health, sports, and education related uses, the final land use plan could support indoor facilities within the study area but would discourage outdoor recreation and schools immediately adjacent to the parkway where the high traffic volumes would create hazardous conditions, especially for children.

The purpose of establishing a land use plan is to regulate land uses within the corridor to those which create an area for economic development and contribute to the establishment of a premier business address.

Light Industrial Land Use

Two locations within the study area are designated specifically for light industrial land uses. These land uses may include manufacturing, assembly, packaging and some small scale distribution and storage. A complete definition can be found earlier in this Section.

The first location reserved for light industrial use is located on the south side of the CSX railroad tracks near Avon. Very few undeveloped rail-accessible sites remain in the Indianapolis area, and the steering committee considered it a high priority to reserve this valuable land for its highest and best use. The light industrial classification would permit any variety of industrial uses which may benefit from the proximity of the railroad tracks, provided CSX can supply a rail spur to the site. The second light industrial site is located south of Avon on the west side of the Parkway between CR 100 S and the retail area along US 40. Avon is currently anticipating bulk warehousing and distribution uses west of this location. With that demand being supplied elsewhere, the steering committee felt it important to provide an area for smaller scale industrial development immediately adjacent to the Parkway. The total area for industrial uses is approximately 439 acres or 10% of the corridor study area. These light industrial uses should be integrated into the road network of any industrial development which occurs west of the study area to provide for concentrated access onto the Parkway.

Flex-Tenant Land Use

Flex-Tenant land uses can take on many characteristics. These spaces are created to provide “store fronts” at the front of buildings with warehousing space behind. Thus, these buildings are generally attractive, giving the appearance of an office structure, but providing multi-functionality, ranging from an office or retail space to a warehousing or even light manufacturing space. Because of its versatility, flex tenant space was selected as the most appropriate land use for the east side of the Parkway between US 40 on the south and the CSX railroad on the north. This area has a great deal of new and established residential housing, making it a difficult location to propose new industrial development.

Flex-tenant spaces tend to have less truck traffic and create a more aesthetically compatible land use adjacent to residential uses than light industrial or warehouses/distribution. Because they generally operate between 8:00 AM and 5:00 PM, they are also more compatible with residential than busy commercial uses. Flex-tenant development in this location should consider its residential neighbors, providing buffering, orienting loading bays so that they do not face residential properties, and restricting lighting adjacent to residential uses. The character of buildings in the area can also be designed to be more compatible with residential uses, highlighting entryways with architectural detailing, providing windows rather than blank facades, and screening parking areas. 656 acres designated for flex will occupy approximately 14.6% of the corridor study area.

The second area designated for flex tenant space is on both sides of the parkway between CR 400 N and the former B&O railroad. This area is within close proximity of Indianapolis Raceway Park and provides an opportunity for racing related facilities. In addition to general industrial users, use of this space may include garages for uses associated with the track and automobile related commercial products.

Bulk Warehousing and Distribution Land Use

Bulk warehousing and distribution uses are already prevalent in the Plainfield and Brownsburg area, both adjacent to the Ronald Reagan Parkway alignment and to the west of the study area. 648 acres, approximately 14.4% of the total land uses are designated for the bulk warehousing distribution uses in the study area. Because these uses present themselves to the roadway as large boxes with featureless facades and because their size tends to dwarf other neighboring uses, the steering committee debated their appropriateness immediately adjacent to this high profile roadway. However, their importance to the economy of Hendricks County is highly valued, and the steering committee agreed that both Plainfield and Brownsburg should be permitted to expand their existing industrial parks to the corridor. This expansion will provide access for the truck traffic from these uses to the I-70 and I-74 interchanges. This access should be provided through a common curb cut onto the Parkway, and bulk warehousing and distribution uses should not be permitted to expand within the corridor beyond the areas laid out in this preferred land use scenario for the expansion of the two existing warehousing and distribution centers.

Special Study Area/ Airport Related Uses

Finally, the area between US 40 and the I-70 interchange on the east side of the Parkway is designated as a special study area for “airport uses”. Much of the land in this area is currently owned by the Indianapolis International Airport.

This special study area is approximately 619 acres, or approximately 13.8% of the project study area. Because the airport has not yet determined its needs for this area as part of the relocation of the terminal and reorientation of the Airport entrance, and due to the environmental constraints on much of the property, this area has been designated by the future land use plan as a special study area. The Town of Plainfield should work with the Airport in the development of this land to ensure it meets the goals and objectives of this document. The airport has agreed to meet with Plainfield to establish guidelines for these areas. In addition, the airport has issued a support statement for the Ronald Reagan Corridor Master Plan.

Development plans in this area should consider the aesthetic appearance of uses, and their impacts on the surrounding land uses. The land close to the I-70 interchange is especially important from a visual standpoint as it will serve as a gateway to Hendricks County for many visitors and consumers. The appearance of the roadway and the impression one receives after exiting the interstate will have a significant impact on the development that is attracted to the corridor and on the overall first impression people get of the County as well. In addition to aesthetic considerations, development in this area should strive to maintain the wildlife habitats that have been created by the airport as mitigation from other development projects.

CONCLUSIONS

In summary, the prevailing theme of the final land use plan for the corridor master plan is one of economic development. There are four major outcomes of the land use plan recommendation. These are the preservation of the corridor as an economic development corridor, the introduction of a Class A/B office space, the establishment of hospitality districts, and the establishment of guidelines for the delineation of industrial and warehouse areas.

The first and primary recommendation is to preserve the corridor as a strictly economic development corridor. Residential development is restricted along the Parkway, reserving land for office, industrial, and commercial uses. The goal of the plan is to establish the corridor as a “premier economic address” for the County, recognizing the opportunities that exist along this corridor, including its access to the “front door” of the airport. By having the foresight to set aside development parcels for their highest and best use, the County and the local municipalities will benefit from an increase in higher paying jobs and higher tax revenue.

The second major outcome of the plan is to introduce an area in Hendricks County for the creation of a Class A/B office complex. With the new Clarian Hospital now situated along the corridor, its adjacent parcels to the north provide the opportunity to tap into the market for medical related office spaces. Intervention will be necessary to set this land aside for the highest and best future use, rather than letting it develop according to current market trends. In the long term, it is anticipated that the potential benefits for the County will greatly outweigh the drawbacks of waiting for development to occur.

The third major outcome is the establishment of Hospitality districts at interchange locations at I-70 and I-74. The development of the I-70 hospitality district will be driven by the market demand for airport-supporting uses. This represents an enormous opportunity, as the corridor will soon become literally the “front door” to the airport. The plan has set aside a special study area for airport-related uses. Many aspects of this area will involve special attention, including environmental issues, height restrictions, and property ownership restrictions. It is the vision of this plan that the hospitality districts will become major anchors to the corridor.

The development of the I-74 hospitality district will be driven by the adjacent Indianapolis Raceway Park. This area will support this key destination with opportunities for tourist oriented uses such as hotels, restaurants, and retail.

The final outcome of the land use plan recommendation is that it establishes guidelines and boundaries for the delineation of industrial and warehouse areas. The market is strong for industrial uses, and it is understood that allowing these uses in a controlled manner will provide numerous benefits to the growth of the local economy. The plan allows for the expansion of the highly successful Airtech Park to its east, and provides other areas for flex-tenant uses. By controlling industrial development before it happens, the outcome will be a more consistent and well-planned corridor.

In addition to the goal of economic development, there are also strong secondary themes of accessibility and mobility along the road itself as well as an overall desire for a high aesthetic quality for the Corridor. These three elements will function together to create a unique, efficient and beneficial roadway for Hendricks County. The access management and aesthetic themes for the study area are discussed in detail in Sections 6 and 7.

The four major outcomes of the land use plan recommendation are:

- The preservation of the corridor as an economic development corridor*
- The introduction of a Class A/B office space*
- The establishment of hospitality districts*
- The establishment of guidelines for the delineation of industrial and warehouse areas.*

Six

Section 6: Transportation

Transportation Enhancements

Enhancements

CORRIDOR DESIGN ENHANCEMENTS

The Ronald Reagan Parkway is not unlike many other similar important roadway connector projects throughout the country. Its underlying purpose is to provide critical transportation infrastructure and function. What is extraordinary about the Ronald Reagan Corridor is the level of thought that is going into its conceptual development--and understanding that the true functional success and potential of a corridor such as this goes far beyond traffic counts and engineering schematics. Hendricks County and the Towns of Avon, Brownsburg, and Plainfield have recognized the immense economic development potential of the corridor, and have prioritized the implementation of key design elements to reinforce that potential. When completed, the Ronald Reagan corridor will not only become a major link within the Indianapolis metropolitan region, but will also be one of the region's few fully-planned corridors.

The Ronald Reagan Corridor Master Plan provides the unique opportunity to establish a design aesthetic and guidelines that will influence both the land use patterns within the corridor and its design aesthetic before it is built. This ability to shape the corridor "before it happens" provides an exciting avenue for establishing a series of goals and having the ability to implement them with less constraints than on an existing roadway enhancement project. The master plan creates opportunities to promote high quality, innovative, and unique design treatments that reinforce the community's vision for the corridor.

The design process of the corridor began with the development of strategic land use decisions, as discussed in the previous Sections. A set of target land uses has been identified that establish a direction for corridor development. Once the preferred land use scenario was established, the second major component of the project was the establishment of a conceptual design for the roadway enhancements. These enhancements further define the overall vision for the corridor set forth in the land use master plan, and are designed to reinforce a level of development desired for the corridor. The result will be a high-quality design statement along the entire corridor that attracts and maintains a similar high-quality level of development.

Goals specifically related to enhancements have been set and established as the guiding principles to be used throughout the design process. The prime goal of the enhancement and site design portion of the master plan, as set forth in the early stages of this project (described in Section 2), is to identify the corridor as a "premier economic address" with the appearance of a master planned development campus. This corridor will not only serve as a critical connector for the local and regional transportation network, but it will also serve as the "front door" to the local communities of Avon, Brownsburg, and Plainfield. This goal will be carried out by implementing place-making improvements along the corridor and enhancing the visual character of the Parkway.

Utilizing design tools to establish a visual richness at a scale that matches the built environment is key to the success of a project such as this one. The recognition that corridors play an important role in defining the image and aesthetics of a community or region is an important first step in creating a unique image for the Parkway. Establishing a visual aesthetic for the corridor requires an understanding of the tools and elements available for creating local aesthetics. There must also be an understanding that these aesthetics must appeal to an auto-oriented community.

The objective of this master plan is to illustrate unified corridor enhancement opportunities in order to guide new development and to establish a consistent theme and palette of enhancements along the entire length of the 12 mile roadway. With this goal of establishing a "premier economic address" as well as implementing a high level of design and unique image for the parkway, the committee explored options for enhancement opportunities and was lead through a decision-making process.

At this highly visible location, it is critical that the gateway be treated with a special design approach. The design of the gateway should create an entry statement that reflects the unique character of the local region, drawing users into the corridor and reflecting a high quality level of design treatment.

Other major destinations have been targeted within the corridor as opportunities to be explored in the design process. These major destinations include the Indianapolis Raceway Park, the new Clarian Hospital, Airtech Park, and local commercial nodes. In particular, Raceway Park has a strong presence along the corridor. Gateway elements and signage will be important features in directing visitors to this destination and celebrating its presence.

Through a series of meetings to determine enhancement options that would best support the project, the steering committee helped the project team identify enhancements that furthered their vision for the corridor. This process resulted in the conceptual design summary plan, the end product of the corridor design enhancements study. The conceptual design summary plan identifies prototypical elements and guidelines for enhancements such as landscape and lighting treatments, gateway elements, a wayfinding system, structural elements, and pedestrian amenities. These elements are programmed in ways which allow opportunities for establishing a consistent character throughout the entire corridor through the use of materials and themes. The character of the corridor will continually evolve as the roadway and new buildings are constructed.

With a plan in place, the Ronald Reagan Parkway will become a premier business address through the development of aesthetic standards which reinforce the high-quality development programmed for the corridor.

OPPORTUNITIES AND CONSTRAINTS

The first step in the process was to explore the existing conditions and important features to determine the opportunities and constraints that exist along the corridor. An existing conditions study was undertaken which included the documentation of existing features including major destinations, existing land uses, residential areas, restricted lands, environmental features, historic and cultural sites, existing transportation systems, and planned transportation improvements. These existing conditions were described previously in Section 3. Several important characteristics have been observed in the site design analysis that will affect the design of the corridor enhancements as both opportunities and constraints.

One primary opportunity for the corridor, as discussed in the previous land use section, is the realignment of the entrance to the airport. This new “front door” will bring airport traffic and visitors to the southern portion of the corridor. The development of a hospitality district with airport-supported uses at this location will naturally establish a major gateway district at I-70 that will be utilized by local, national, and international visitors.

The airport also creates some additional opportunities and constraints. One of the primary constraints in the development of land within the district will be the building height restrictions. The southern portion of the corridor runs directly below the approach patterns for the two major runways at the Indianapolis International Airport. As such, there are Federal airspace requirements governing these approach zones. The calculations and formulas used in designating the height restrictions is based off of pre-determined glide ratios in relation to sea level. The glide path is calculated from the end of the runway. The height restriction begins 2000 feet from the end of the runway and rises 1 vertical foot for every fifty horizontal feet. The elevations are fixed points based off of sea level and an established elevation at the end of the runway. From these two datum points, maximum heights can be calculated. Because the existing topography fluctuates, height limitations vary in the approach zone.

For purposes of illustration, the federal height restriction was roughly calculated and presented to the steering committee at its February 18 meeting. The intersection of the Ronald Reagan Corridor and Stafford road was used as a fixed point. The height restriction for this location was estimated at 70 feet, based off of the federal regulations.

Marion County has much stricter height restrictions that they use in similar areas in Marion County. It uses the same datum, but uses a 1:100 ratio of vertical to horizontal for the glide path. If the Marion County standard was used at this same intersection, the height restriction would be 9'. It is important to note that Hendricks County *has not* adopted the Marion County standards.

These height restrictions will affect the types of development that may occur at this major gateway and could become a constraint. However, if deemed undevelopable for airport-related reasons, these areas may provide opportunities for potential enhancement treatments, landscape treatment areas, view enhancements, or community open space.

Another significant airport-related constraint to development near the airport is land restricted for environmental purposes. Several environmental mitigation areas occur near and around the airport. Most significant of these is the endangered Indiana Bat habitat. Specific airport-owned lands have been designated to preserve crucial habitat and mitigate the environmental impacts of recent construction activities. These areas will not be open to development, but could offer future opportunities in other areas. An example of these opportunities included the current development of the White Lick Greenway in or near these restricted lands.

Pockets of valuable natural features also exist within the corridor. Woodlands, wetlands, streams, and lakes, are a valuable asset to the corridor, and efforts should be made to preserve these areas where appropriate. The preservation of natural features provides the opportunity to enhance the overall aesthetic of the corridor while preserving natural systems. These natural systems are discussed in more detail in Section 3.

Another major element to be considered in the design is the proximity of numerous residential neighborhoods. There are several residential communities near the corridor that have been documented in the site design analysis. These are illustrated in **FIGURE 6.1**. These communities afford the opportunity to support many of the land uses proposed in the preferred land use scenario with a readily accessible employment and consumer base. These residential areas near the corridor must be considered in the design development of the Parkway. It will be important to establish pedestrian amenities and trails in order to link the local residential community to the corridor and the surrounding region.

The presence of rail lines, both active and abandoned, have also been identified in the site design analysis as having an important impact on the corridor. The rail lines provide huge opportunities for development by providing potential access to rail transportation. The physical constraints include the free movement of vehicles and pedestrians across very active lines. The County has taken this into account, and both rail lines will have grade-separated bridges. It will be important that these bridges accommodate the pedestrian movement along the corridor as well. The abandoned B&O corridor, currently an abandoned rail line but proposed as a greenway, will provide the unique opportunity of linking the Ronald Reagan Corridor to outlying areas by way of a rail-trail.

FIGURE 6.1: Residential Communities

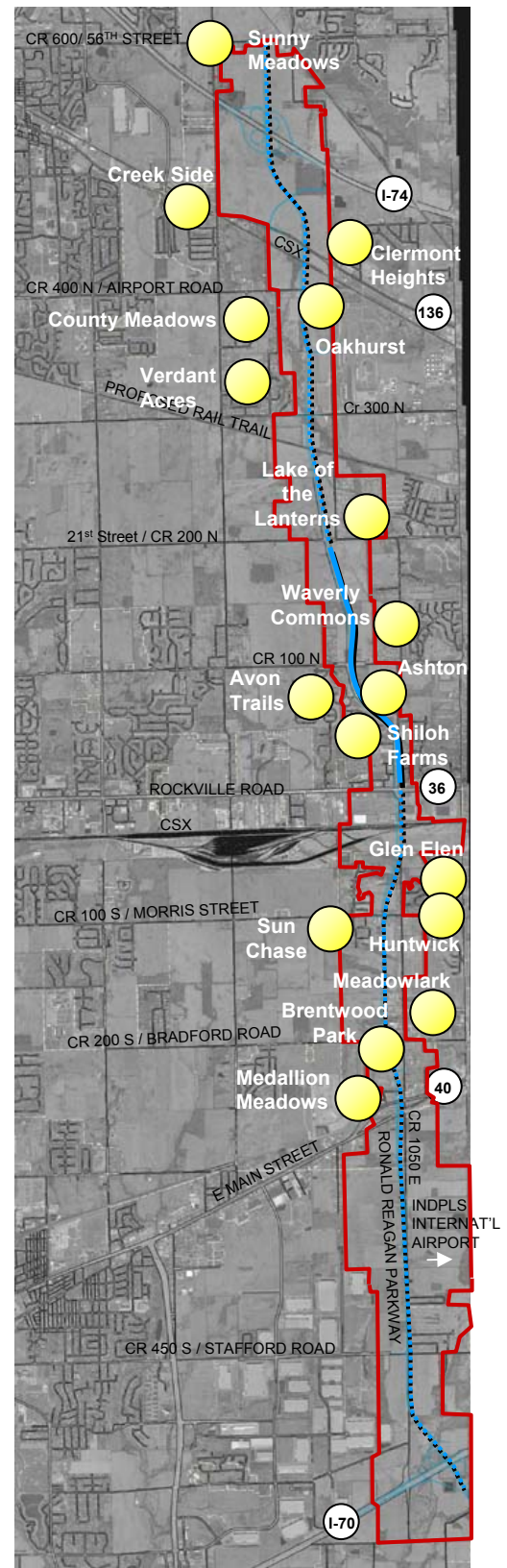

The corridor offers significant opportunities for pedestrian connectivity. Construction of a trail along the corridor would provide major pedestrian connections between the three communities, connecting Avon, Brownsburg, and Plainfield. Furthermore, the corridor's connection to the future B&O rail corridor and the White Lick Greenway, creates a county-wide connection to areas beyond Hendricks County. When completed, the connection to the B&O trail would make it so that residents in any of the three communities could walk or bike from downtown Indianapolis, via the connections to Indianapolis' greenway system. This opportunity demonstrates how completion of the 12-mile corridor results in much greater impacts than just that 12 miles.

The corridor's unique opportunities provide a basis for the design exercises to follow, and most importantly, they provide a justification for corridor-specific issues that must be considered in the design of the parkway.

The opportunities and constraints analysis also highlighted several key nodes along the route. The nodes included:

- Key entrance and exit points to the corridor
- Key destinations along the corridor
- Key routes and connections made available by the roadway
- Key transportation improvements

By identifying and understanding these nodes, design opportunities and constraints were brought into the design process in order to make the plan a comprehensive tool.

ALTERNATIVE DESIGN CONCEPTS EXERCISE

As part of the enhancement development for the Ronald Reagan Corridor Master Plan, an alternative design concepts exercise was conducted to establish a clear direction for the preparation of the design treatment for the corridor. The alternative design concepts exercise was undertaken to engage the committee in a decision making process to determine the preferred level of treatment for the corridor enhancements.

FIGURE 6.2 outlines the corridor enhancements design process. Several treatment options were presented, and the committee was asked to vote on their preferred level of treatment. Minimal, moderate, or aggressive levels were presented for each type of treatment. The categories included landscape and lighting elements, gateway elements, wayfinding signage, structural elements, and pedestrian amenities. The results of this survey were tabulated and utilized to establish a consensus for the preferred level of treatment for each enhancement considered. The final result is a summary of consensus issues that were used to determine the overall level of enhancement treatment and to guide the design process.

FIGURE 6.2: Corridor Enhancements Design Process

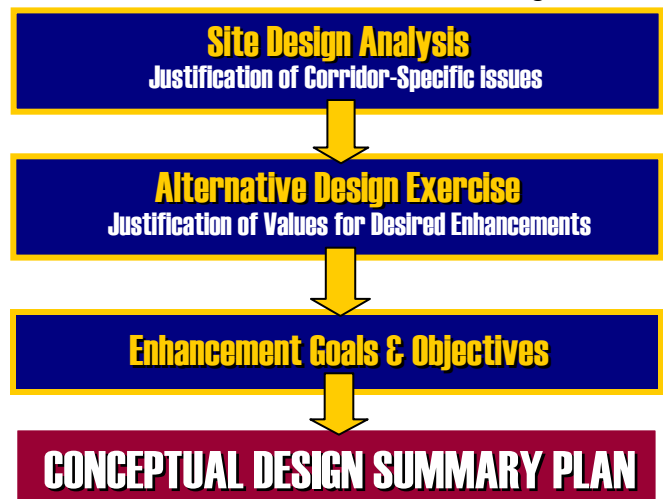

The summary of consensus issues that resulted from this exercise is listed as follows. These items represent the preferences indicated by the steering committee:

- Informal Landscape treatments
- Landscaped Berms
- Landscaped Medians With Minimal To Moderate Hardscape And Softscape Accent Treatments
- Moderate Lighting Enhancements
- Structured Gateway Treatments
- Specialty Wall Treatments
- Moderate Thematic Treatments
- Themed Corridor-Specific Wayfinding System
- Enhanced Wall Treatments at Bridges
- Inclusion of Multi-Use Trail

The overall recommendation of the steering committee reinforced a high-quality of physical design treatment along the corridor. The committee recognized that the value of development will be dictated by the level of enhancement treatment. They selected a high-quality above average level of treatment, but rejected an overly aggressive enhancement plan. The overall recommendation was that the physical design enhancements along the corridor should be unique to the corridor, and should maintain a higher level of design standards than other roadways in the region. This exercise was very valuable in the overall process, as it provides a strong justification of values for the desired enhancements along the parkway.

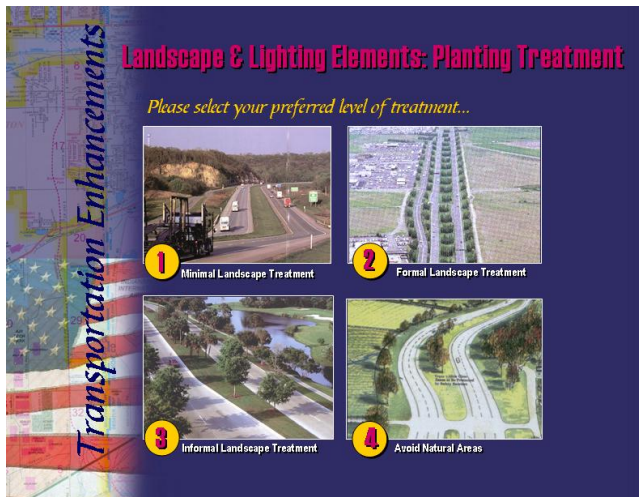

FIGURE 6.3: Example of Alternative Design Concepts Exercise

The purpose of the roadway enhancement plan is to reinforce the level and quality of development along the corridor by creating a unified, consistent, recognizable, and high-quality aesthetic unique to the corridor.

CONCEPTUAL DESIGN SUMMARY PLAN

Once a desired level of treatment was established, the design team began preparing the conceptual treatments. The findings from the alternative design concepts exercise were utilized as a basis for the creation of the prototypical concepts in the conceptual design summary plan. The conceptual design summary plan is the translation of the consensus issues into a conceptual design. This plan utilizes prototypical concepts and shows how they can be applied to the corridor. The plan covers a wide range of enhancements, and directly corresponds to the desired levels of treatment established as the consensus issues. Conceptual sketches were used to illustrate each prototypical concept. In addition, each prototypical concept was applied to the roadway section in order to demonstrate how the concept would fit into the context of the corridor and other roadway features. Typical examples of these prototypical concepts are illustrated on the following pages. Specific recommendations and illustrations for each prototypical concept are described in more detail in the sections that follow. All of the concepts are directly related to the desired level of treatment determined by the committee.

The conceptual design summary plan is based on 5 design categories of design enhancements. These categories, landscape and lighting treatments, gateway elements, wayfinding signage, structural elements, and pedestrian amenities, together establish the basis for the enhancement design. Some of these elements, including pedestrian amenities and landscape and lighting treatments, will be utilized the entire length of the corridor. They are the unifying elements that will help to establish a framework for the corridor's visual image. Additional customized elements will help to create a special identity for the corridor, and reinforce its image as a premier address in the region. These elements include gateway elements, wayfinding signage, and structural elements that will be introduced at key locations as accents and special treatments. They will complement those elements that extend the entire length of the corridor by careful attention to detail in the design development stages of the project. The means for applying the conceptual design elements to the corridor is illustrated in the diagram in **FIGURE 6.4**

RONALD REAGAN

Corridor Master Plan

BASELINE: THE ROADWAY

In order to illustrate the prototypical concepts for the roadway, the design team established basic roadway design standards for the corridor. The roadway will function similar to a divided 2-lane highway with two lanes in each direction. The given right-of-way for the parkway has been set at 160'. The fairly generous right-of-way will provide ample room for the inclusion of turn lanes where necessary as well as additional right-of-way for enhancement features. For purposes of this exercise, the median has been set at a typical 16' width, with the understanding that exact dimensions of this median shall be determined in final design stages. This roadway cross section with 160' right of way, median treatments throughout the corridor, and 2 lanes in each direction provides the "baseline" which was utilized for the prototypical design concepts for the parkway. The baseline section of the roadway will be utilized to help portray how design components will fit into the context of the roadway. A typical cross-section of the roadway shown in **FIGURE 6.5** illustrates the baseline that will be utilized in the enhancement design process.

FIGURE 6.4: Conceptual Design Elements

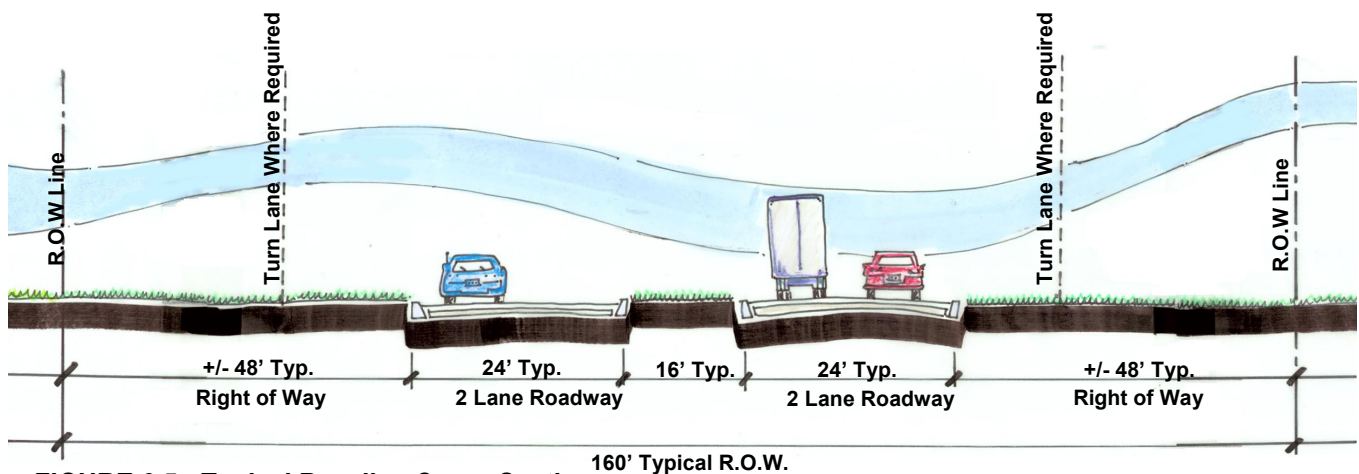
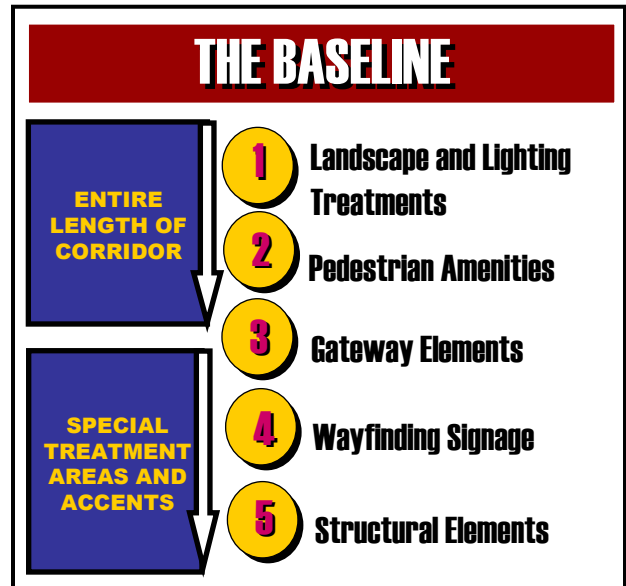

FIGURE 6.5: Typical Baseline Cross-Section

LANDSCAPE AND LIGHTING ENHANCEMENTS

Design Intent: to utilize landscape and lighting features as important unifying design elements within the corridor to promote a well defined aesthetic and a safe environment along the entire length of the Parkway.

The first level of enhancements that was explored was the utilization of landscape and lighting elements along the corridor. These types of features, by their very nature and function, can be applied to the corridor in a very simplistic manner. For example, roadway lighting is a very necessary component of any major roadway. The decision to utilize an ornamental light versus a standard will certainly be at an additional cost, but the additional cost of enhancing the aesthetic value of a functional light pole is overall a very effective means of establishing a unique visual image for the corridor.

On their own, lighting and landscape features represent the simplest and most cost effective means of providing a unifying element that will help to establish an enhanced level of treatment for the corridor. The following landscape and lighting treatments have been recommended for use along the parkway:

- Informal landscape treatments in right-of-way
- Landscaped berms and screens
- Landscaped medians, and
- Ornamental lighting.

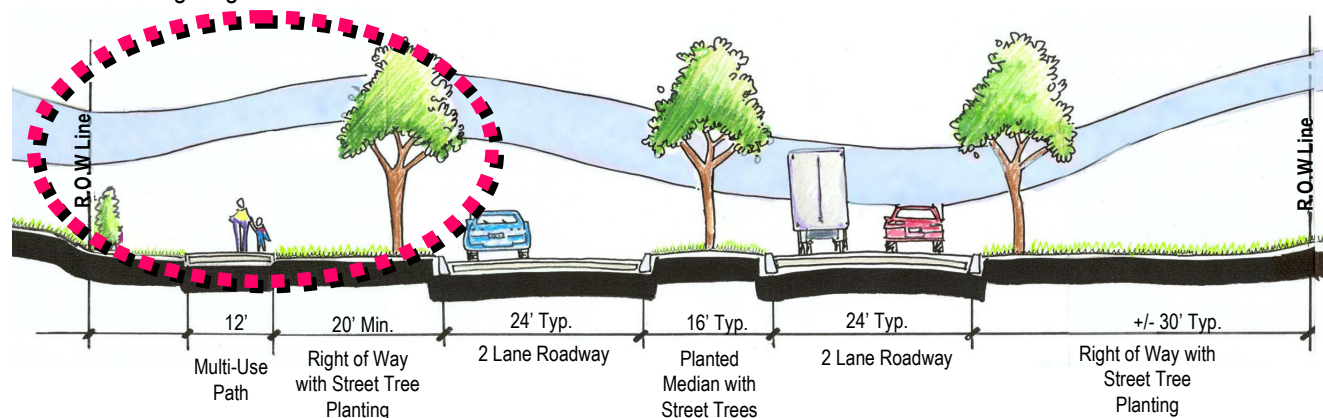

FIGURE 6.6: Informal Landscape Treatment Section

RONALD REAGAN

Corridor Master Plan

Informal Landscape Treatment

The landscape theme adopted by the parkway is the establishment of an informal landscape treatment with a natural look and feel. In the alternative design concepts exercise, the steering committee was presented with optional types of landscape treatments in order to determine a landscape aesthetic for the corridor. The options presented included a minimal level treatment that depicts no special landscape treatments, a landscape treatment with a formal look, one with an informal look, and a more aggressive approach which completely avoids existing natural areas in an effort to preserve the existing character of the roadway.

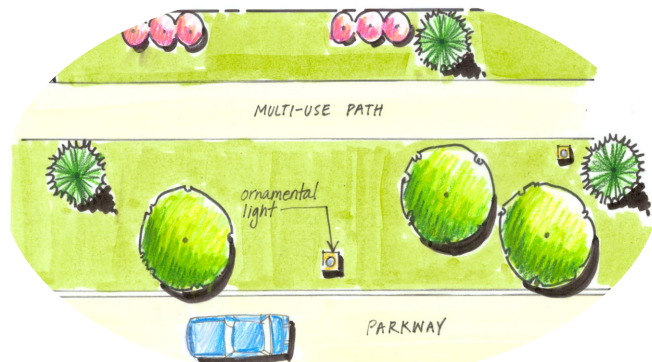

FIGURE 6.7: Typical Informal Landscape Treatment

The options presented are not necessarily ranked in the order of treatment level, but rather by a design aesthetic and character. By consensus, the character that was selected by the steering committee was an informal landscape treatment, similar to that of a “traditional parkway.” **FIGURE 6.8** represents the image that the steering committee selected.

Right-of-way plantings and buffer plantings will be utilized in the landscape design to establish a look and feel that is distinctly the Ronald Reagan Parkway. The vision for the corridor landscape is to establish a scenic roadway design with a natural appearance. This is accomplished by utilizing the right-of-way as a palette for the establishment of a consistent landscape theme. In contrast to the formal scene depicted by rows of marching trees along many urban roadway treatments, the concept for the Ronald Reagan Parkway is that of a naturalistic or scenic appearance. This look can more easily be achieved because of the generous right-of-way available for enhancements, typically around 30 feet.

The landscape treatment concepts, as illustrated in **FIGURE 6.6 and 6.7** portray groupings of shade trees, ornamentals, and evergreens, in naturalistic patterns. These natural patterns, used consistently throughout the corridor will establish a natural feel throughout. Trees will not only provide a dramatic roadway aesthetic, but will also create an attractive visual and psychological separation for pedestrians utilizing the multi-use trail.



FIGURE 6.8: *The steering committee selected an informal landscape theme for the parkway, with informal plant massings and naturally, random spacings.*

A list of recommended trees and shrubs is included in the appendix of this document. Tree and shrubs selected should reflect the regional landscape and preference should be given to locally grown, native species.

Informal Landscape Treatment Guidelines

- The corridor should portray a natural appearance in plant types and densities.
- Tree and shrub plantings shall be planted in natural patterns or clusters in order to convey a naturalistic appearance.
- The trees and plants selected should reflect the surrounding regional landscape, and preference should be given to native species. Locally grown nursery stock is highly encouraged.
- Groundcovers, shrubs, perennials, and native seed mixes are encouraged at gateway locations and special accent areas.
- Natural woodland areas should be protected to the greatest extent possible.
- Where streets intersect with Ronald Reagan parkway, proper sight lines shall be preserved.
- Special attention shall be given to plant trees to provide shade in those areas of high pedestrian-activity.

Landscape Screens

The committee also discussed the use of screens along the parkway. The optional screen types presented included a minimal level treatment that depicts little or no screen treatments, a screen treatment utilizing plant material only, one utilizing a combination of screens and berms, and a more aggressive approach which utilizes plantings, berms, and walls. The consensus adopted by the steering committee is the use of a combination of screen plantings and berms to block undesirable views. **FIGURE 6.9** shows the photo that the steering committee selected that best represents the desired image for parkway screens.

Screen treatments should be used to provide landscaped buffers in areas where screening is necessary to maintain the visual character of the site. This is especially critical in predominantly industrial type land uses. Berms with dense landscaping shall be incorporated into projects to screen unattractive views and features such as storage areas, trash enclosures, parking lots, public utilities, and other elements that detract from the appearance of the surrounding area. Parking areas fronting the parkway should be screened with landscaped berms, providing a natural and harmonious appearance with parkway landscaping and nearby structures. In the case of parking lots, vehicles need not be completely screened from sight, but rather, a visible break should be provided between the parkway and parking areas. Screening should also be provided for mechanical equipment and dumpsters, if visible from the roadway. Reasonable efforts should be made to position such equipment at the rear of buildings. The use of landscape and berms to screen undesirable views will help to further reinforce the continuity of the parkway and the desired naturalistic landscape aesthetic. **FIGURES 6.10 and 6.12** on the following page illustrates prototypical screen treatments. The following is a list of guidelines for landscape screens.

Landscape Screen Treatment Guidelines

- Screen plantings should consist of a combination of plantings and berms. Tree and shrub plantings on berms should be grouped together in natural patterns or clusters in order to create a naturalistic appearance.
- Landscaping in conjunction with the use of berms should be incorporated into all projects in order to screen unattractive views and features from the parkway. The following new facilities should be screened from view:
 - trash collection areas
 - delivery/loading areas
 - major above grade utility installations
 - most surface parking lots
- A themed plant palette should be established, listing plants for repeated use along the entire length of the parkway to further establish a sense of landscape consistency.
- The design of berms should be compatible with the local landscape character and topography. Significant landscape screening shall be provided between incompatible uses.



FIGURE 6.9: *Landscape Berms are the preferred type of screening treatment along the parkway.*

Landscaped Medians

The steering committee looked at four treatment options for landscaped medians along the corridor. The options presented included a minimal treatment with a grass-only median, a moderate treatment with a tree-lined median, a moderate median treatment with a mix of hardscape and softscape, and an aggressive theme-related treatment with landscaping, lighting, and custom designed theme structures similar to the level of Hulman Memorial Way.

The response to this discussion resulted in a preference for two of the options presented: a mix of hardscape and softscape treatments in a fairly aggressive level and the use of landscape elements only in the median. The recommendation for this treatment is to compromise the differing options by using landscaped medians with a moderate use of additional hardscape and softscape accents.

FIGURE 6.13 on the following page shows both photos that the steering committee selected representing the ideal for the use of median treatments along the parkway. Keep in mind that the recommendation is a treatment that reflects a consensus somewhere in between the two options selected by the steering committee.

Medians will result in many other positive outcomes for the corridor including establishing a high level of pedestrian and vehicle safety, ensuring smooth traffic operations, minimizing traffic congestion, and supporting the efficient movement of freight and goods. Not only will medians function to improve safety by directing and separating traffic, they will also provide a strong visual impact along the corridor. FIGURE 6.10 and 6.11 below illustrate a typical landscaped median in section and in plan view.

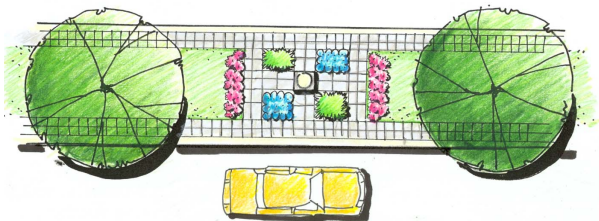

FIGURE 6.11: Typical Median Accent

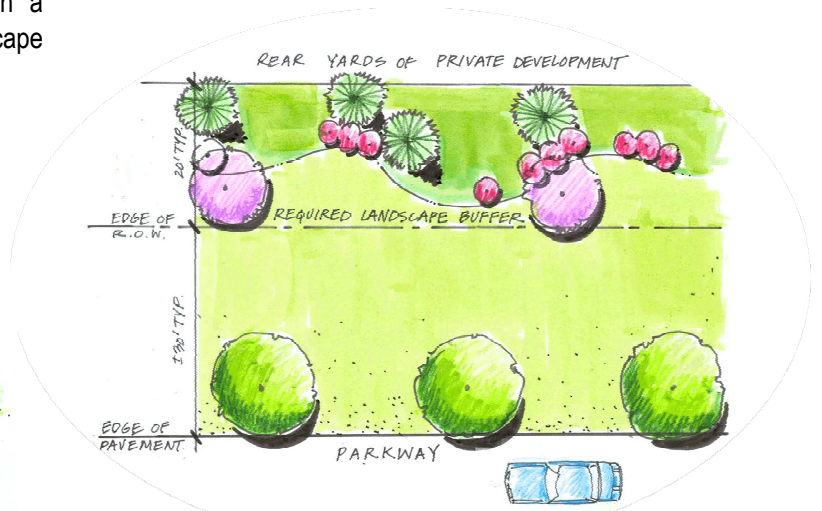

FIGURE 6.12: Typical Landscape Screen

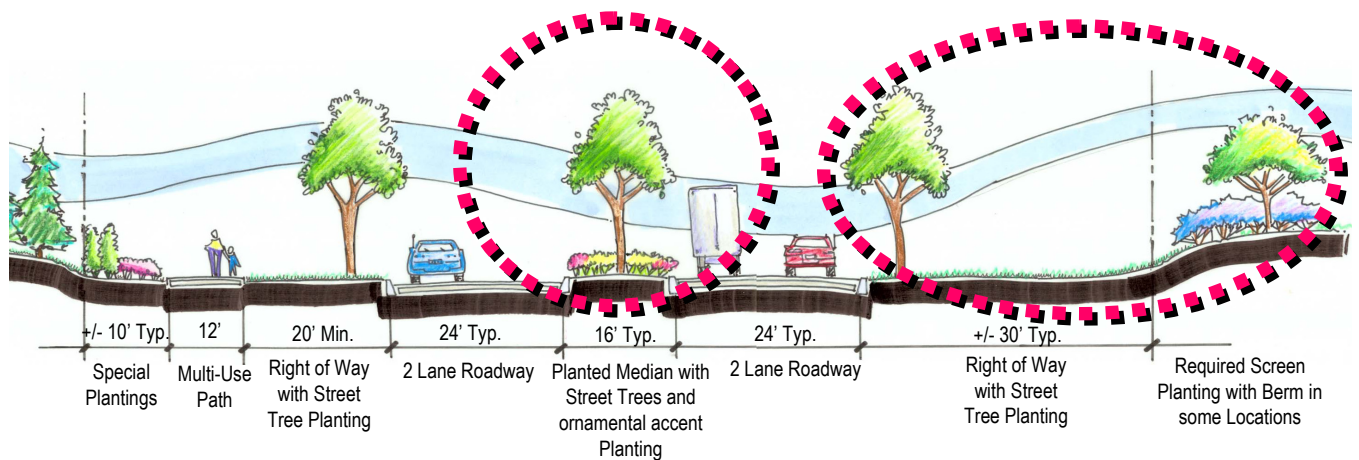

FIGURE 6.10: Landscape Screen Treatments and Median Accents Section

The typical median cross-section for the parkway is at least 16' wide and includes a raised median with curb. Curbing will establish separation from the median and the travel lanes, and will allow for the planting of trees in the median. The use of the median along the entire corridor, except in areas where the right-of-way does not permit, shall be necessary for establishing consistency along the entire corridor. Medians will be terminated, where necessary, providing turn lanes for access to roads. It is important that median breaks are carefully coordinated with traffic patterns to better enhance the traffic flow. This will be further discussed in the Traffic Management Section.

A consistent pattern for the landscape design of the medians will help to further unify the corridor. This pattern for all median plantings complements the established landscape treatment, portraying a naturalistic look. All medians will be planted in turf and/or groundcover, and will utilize tree species consistent with those along the public-right-of-way. These should be selected from the Recommended Tree Species List in the Appendix of this document. Groundcover planting in the median is not only aesthetically appealing, but is also low maintenance. It is important that trees are more closely spaced within the median to create a canopy-effect. The use of hardscape materials behind the curb will reduce the amount of salt spray on plants resulting in less maintenance and replanting of dead materials.



FIGURE 6.13: *The recommendation for median treatments along the parkway is a compromise that utilizes components of both images above, resulting in the desired outcome of landscaped medians with the moderate use of additional hardscape and softscape accents.*

FIGURE 6.14: *Prototypical median accent treatments illustrate a mix of hard and softscape accents in special areas such as at median noses and at the locations of parkway gateway elements.*

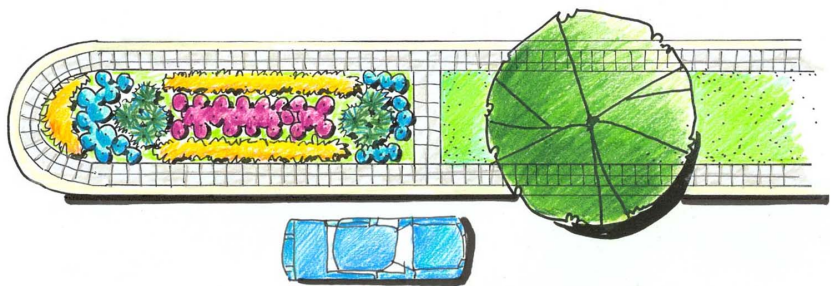

The use of clustering and natural patterns will help to further reinforce the naturalistic theme established for the parkway. In order to provide an additional layer of interest, special landscape accents are established at high-traffic areas and at median noses. These accents will introduce an additional layer richness in detail in areas where color and texture will be visible to vehicular traffic. In addition to plantings, special paving accents will be used in a consistent manner along the entire corridor. This may be by the use of a stone paving accent band along the entire length of the medians, or it may consist of a simpler treatment of paving accents at median noses only. These pavers should match the color palette utilized in the gateway signage and monuments. In addition, the following guidelines have been established for the parkway medians;

Landscape Median Guidelines

- All medians shall receive landscape treatments, except where median width is a limitation.
- Medians shall be consistently designed, with a similar palette of materials along the entire length of the corridor.
- Plant materials and patterns shall further reinforce the naturalistic theme established for the parkway.
- Landscape accents shall be utilized at median noses and to accent special features such as corridor gateway markers.
- Sight lines and visibility at intersections and crossings should be a major priority in the design of the medians.
- Paving accents in the medians shall be utilized in a consistent manner throughout the entire parkway.
- Median treatments should maintain a consistent appearance along the entire length of the corridor. However, size, spacing, and species may vary. The design of the parkway medians shall be done in a comprehensive manner for the entire corridor.
- A themed plant palette should be established, listing plants for repeated use along the entire length of the parkway to further establish a sense of landscaping consistency.

Lighting Enhancements

Several options were presented to the steering committee for potential lighting treatments. These ranged from the standard cobra-head lights, moderate lighting enhancements with decorative elements, and themed corridor-specific custom lighting treatments. The level of treatment selected by the committee was the use of moderate lighting enhancements. The image preferred by the committee depicted an ornamental light with decorative pole, decorative light fixtures, and special medallions with same type of regional or local branding logo. This image is shown in **FIGURE 6.15**. The information gleaned from this exercise was applied to the preliminary design concepts for the lighting treatments described below.

Lighting may be utilized to provide interest, variation, character and identity for an area. More importantly, lighting provides for vehicular and pedestrian safety. By ensuring safe travel, the introduction of pedestrian lighting further encourages pedestrian activity. The typical recommended lighting treatment for the Parkway is a coordinated system of streetlights and pedestrian lights. Motor-vehicle scaled street lighting and pedestrian-scaled lighting are provided as a complement to one another, ensuring that both the Parkway travel lanes and pedestrian paths are effectively illuminated. The typical ornamental streetlight treatment proposed utilizes a Cambridge style pole and arm with a teardrop globe luminaire. The clean lines represented in the style of this pole are consistent with the style of other corridor elements, such as the gateway monuments discussed in later section. Roadway lighting will be aligned along the Parkway at consistent intervals that provide adequate light for all travel lanes and a unified look along the corridor.

It is recommended that a corridor medallion be utilized on light poles to reinforce the theme and character of the corridor. This medallion will feature a Parkway symbol that may also be utilized on gateway features. In addition to the parkway medallions, themed corridor-specific banners may also be applied to the streetlights in order to

promote special events related to a specific destinations along the corridor. **FIGURE 6.19** illustrates the application of parkway lighting along the corridor, and typical streetlights and the use of parkway medallions and banners are depicted in **FIGURE 6.16**, **FIGURE 6.17**, and **FIGURE 6.18**.



FIGURE 6.15:
The preferred level of lighting enhancements for the Parkway is the use of an ornamental light with a decorative pole, decorative light fixtures, and special medallions with the parkway name or logo.

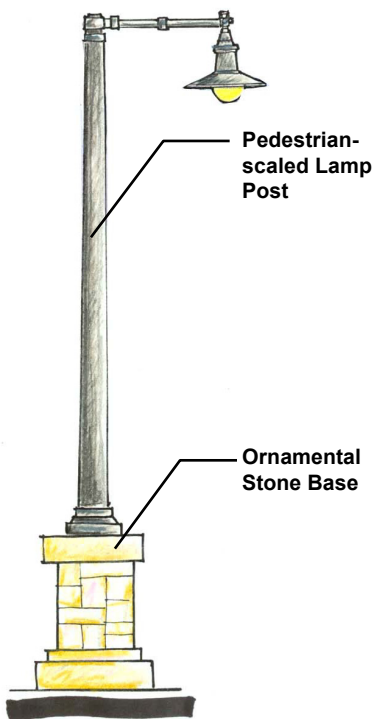

FIGURE 6.16:
Typical Pedestrian Light

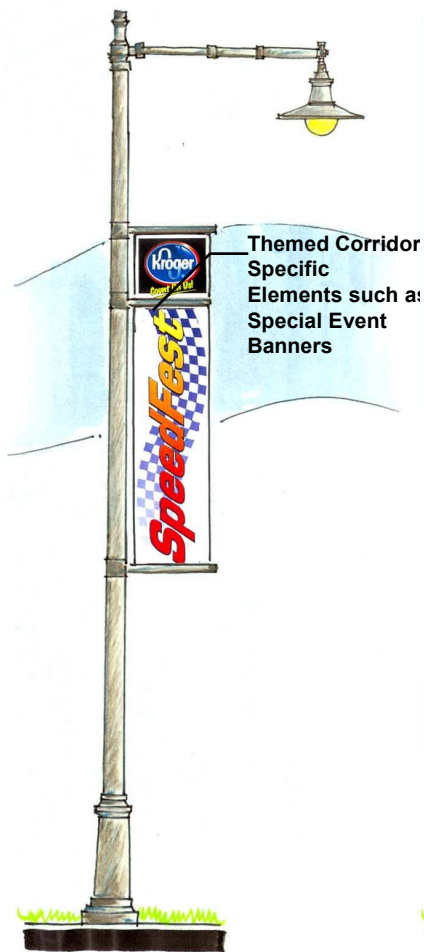

FIGURE 6.17:
Typical Ornamental Light
with Theming

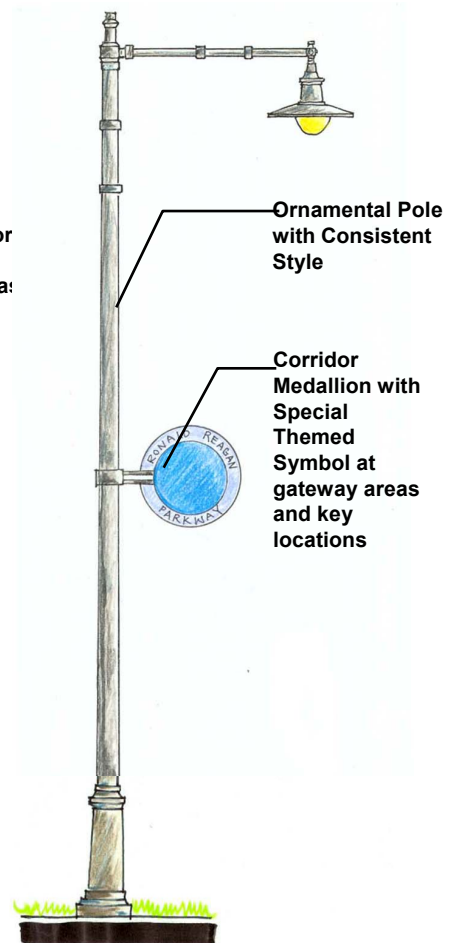

FIGURE 6.18:
Typical Ornamental Light

Pedestrian-scale lighting is recommended in areas of high pedestrian activity and where its implementation is practical. Pedestrian-scaled lighting improves accessibility by illuminating sidewalks, crosswalks, curb ramps, and signs. This includes highly trafficked areas along the multi-use path such as commercial, residential, and office park zones.

The style of these pedestrian lights coordinates with the roadway lighting. In addition, an ornamental stone base is utilized for the pedestrian-scaled lamp post in order to introduce an additional layer of detail at the pedestrian scale. The base of the pedestrian light utilizes the same family of materials utilized in the gateway features in order to tie these elements together. An illustration of a typical pedestrian-scaled light is shown in **FIGURE 6.16**.

In addition to street and pedestrian lighting, under-bridge lighting and landscape lighting shall be utilized at gateways for both safety and aesthetic reasons.

Special care and consideration should be made in the design of the lighting along the corridor in order that it does not cause a false image of an airport runway.

The utilization of lighting along the Parkway will not only meet the objective of establishing a safe environment, but provides a tremendous enhancement opportunity that will greatly contribute to the aesthetic of the corridor.

Lighting Enhancement Guidelines

- Streets, sidewalks, and paths should be illuminated with a low-intensity, high-quality light, which provides good, uniform visibility while avoiding light pollution.
- Lighting shall be fully shielded and full-cut off in order to avoid light pollution and to avoid conflicts with the airport.
- Lighting style shall be consistent along the entire length of the corridor.
- Streetlights shall be at a minimum of every 300 to 350 feet on center staggered on opposite sides of the street and at intersections.
- Lighting column foundations shall not extend more than 4 inches above finish grade.
- Care should be taken in coordinating the location of street and pedestrian lighting in relation to trees in the right-of-way. The placement of trees, considering their mature height should not obstruct lighting.
- Lighting shall be configured in a way that shall not cause a false image of an airport runway.

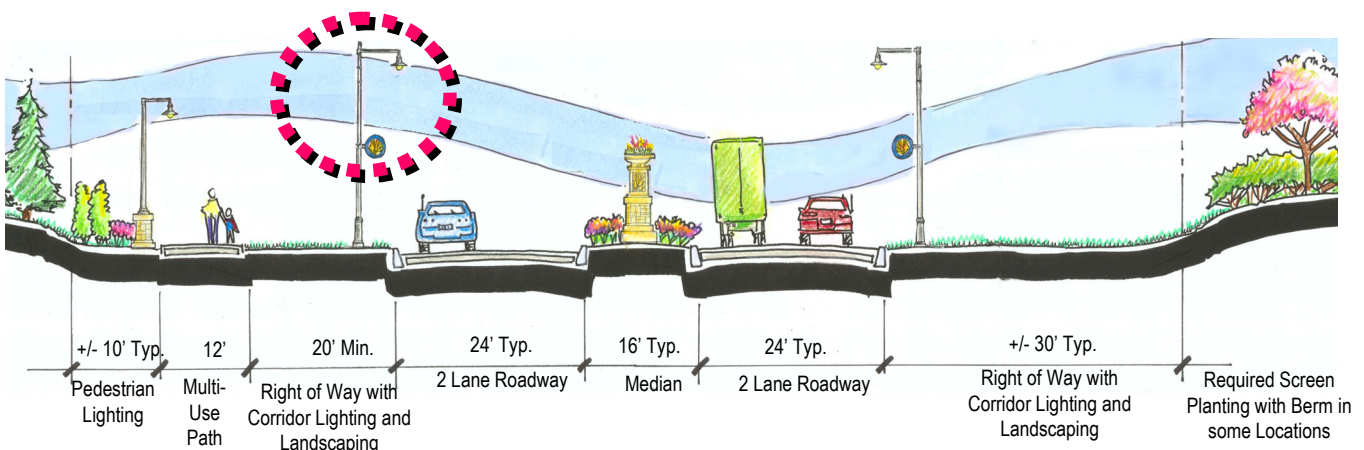

FIGURE 6.19: Lighting Enhancements Section

RONALD REAGAN

Corridor Master Plan

Summary of Landscape and Lighting Treatments

In summary, landscape and lighting features are important design elements that will help to promote a well defined aesthetic and a safe environment along the entire length of the parkway. The landscape and lighting treatments selected for the Parkway utilize moderate applications and traditional streetscape elements. Informal landscape treatments and moderately landscaped medians are utilized along the entire corridor length. In addition, berms for screening are utilized in some locations. Special accent plantings are utilized at median noses, intersections, and gateways. Ornamental lighting that continues the entire length of the corridor also contributes to a unifying theme. The map to the right in **FIGURE 6.20** demonstrates the application of landscape and lighting treatments to the entire length of the corridor highlighting gateways and special intersection treatments.

Landscape and Lighting Summary:

- Informal Landscape Theme
- Landscape gateway treatments at interchanges and intersections
- Moderately landscaped medians
- Berms for screening in some locations
- Ornamental lighting along entire corridor
- Special Accent Plantings
- Under-Bridge Lighting & Landscape lighting

Legend:

- Ronald Reagan Pkwy (Planned)
- Ronald Reagan Pkwy (Constructed)
- Potential Landscape Treatment of Major Intersections/ crossings
- Potential for major gateway landscape treatment

FIGURE 6.20: Corridor Application: Landscape and Lighting

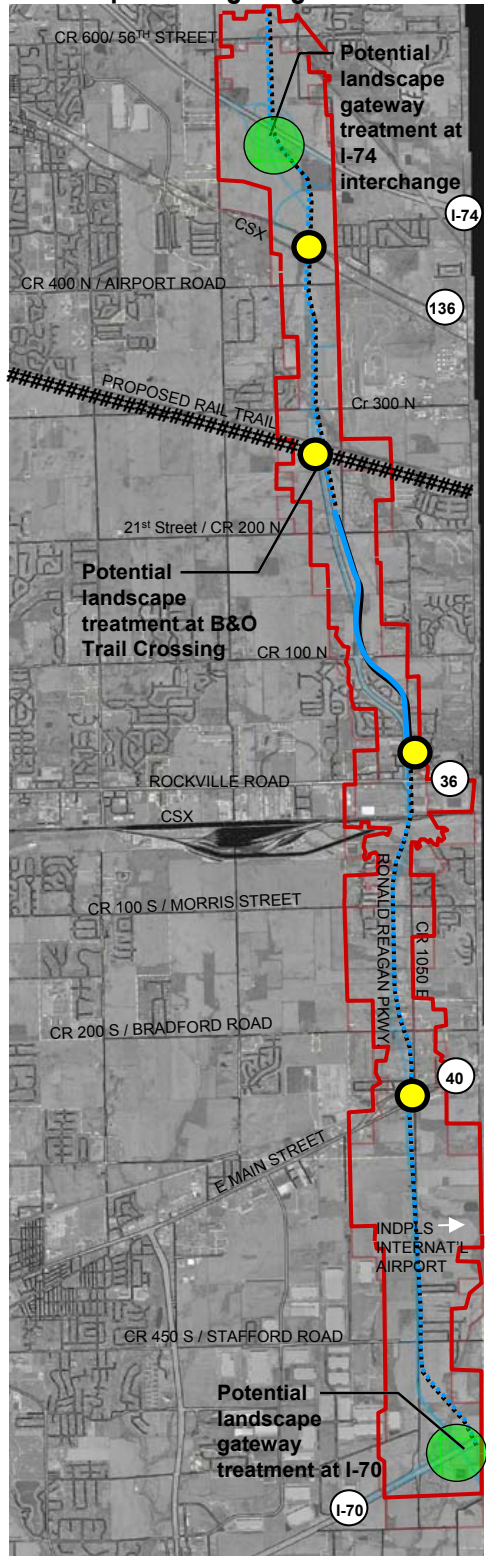

GATEWAY ELEMENTS

Design Intent: to provide a series of gateway features that creates a memorable impression of the Parkway and communicates a positive welcoming message to all who travel along its path.

Gateway elements are one of the single most important features in establishing a unique identity for the corridor. Gateway features can help to establish the theme and initial “look” of the corridor. Without them, the corridor will likely not set itself apart from other parkways of a similar caliber. The intent of the gateway elements is not only to emphasize the interchanges as key gateways, but also to create a unique entry sequence effect.

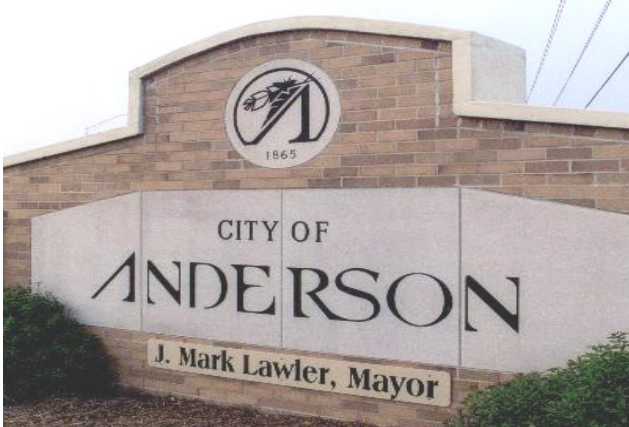

FIGURE 6.21: *The recommendation for gateway treatments along the parkway utilizes structured gateways with specialty wall and signage treatments.*

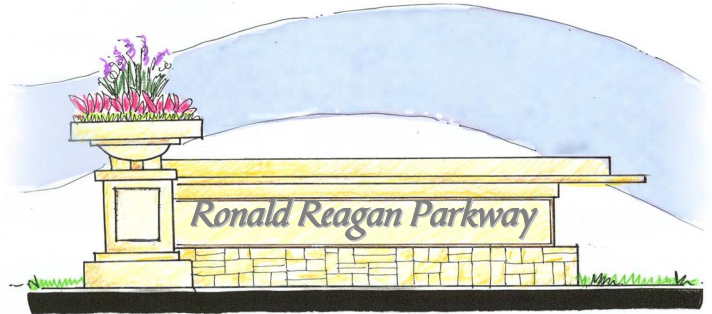

FIGURE 6.22: Typical Major Gateway Sign

Several gateway design features are recommended for the Parkway, including: major gateway elements, corridor gateway markers, secondary gateway signs, and intersection enhancements. Each of these elements contributes to the creation of an unique flavor and unifying theme for the Parkway.

In the alternative design concepts exercise, the steering committee was presented with optional types of gateway treatments in order to determine a landscape aesthetic for the corridor. The committee looked at various types of treatments, including no gateway treatment, subtle gateway treatments, structured gateway elements, and enhanced treatments with corridor-specific themes. The option preferred by the steering committee was the use of structured gateway elements. An example of this type of gateway treatment is shown in **FIGURE 6.21**.

Wall and signage treatments were also considered. The optional treatments included minimal signage treatment, small local signage, larger entry signs with enhanced materials, and corridor-specific signage with enhanced treatments. Both large entry signs with enhanced materials and corridor-specific signage were favored. Therefore, it was concluded that specialty wall and signage treatments were desired along the corridor. The final consideration was the use of themes. Themed streetscapes were presented ranging from minimal treatments, moderate treatments, and themed amenities. The theme selected was that of a moderate treatment utilizing traditional streetscape materials. Overall, each of these favored gateway treatments falls into a moderate category. This information was applied to the preliminary design concepts for the gateway elements described below.

RONALD REAGAN

Corridor Master Plan

Major Gateway Elements

The gateway concept selected for the parkway is the establishment of structured gateway treatments. In addition to structured gateways, the committee preferred that signage and specialty wall treatments be utilized to establish a moderate gateway theme. The design of the major gateway elements reflects a refined design that utilizes structural design elements to suggest subtle themes. In addition to traditional intersection enhancements that would occur along the corridor, the interchanges at I-70 and I-74 lend themselves to the inclusion of special gateway features. These major gateways could include various elements such as sculptures, flag or banner poles, gateway monument signs, and special planting treatments. These gateways will be utilized to create a major entry into the parkway and to clearly identify it as the “Ronald Reagan Parkway.” They will become the signature entryways into the corridor. Illustrations of concepts for the parkway’s major gateways are shown in **FIGURES 6.22 and 6.23**. Large gateway signs with an integral planter reflect a palette of neutral stone materials that is utilized in numerous design elements throughout the Parkway. In addition, flags are utilized to mark the entry into the corridor and to introduce a subtle patriotic theme. Major gateways should be accented by special plantings to introduce an additional layer of color and texture into the environment.

Major Gateway Guidelines

- The gateways should be positioned to appropriately depict a sense of entry into the corridor.
- All major gateways should introduce the “Ronald Reagan Parkway” name into its gateway elements.
- Gateway signs should incorporate natural stone materials. The style and materials of gateway signs shall be coordinated with the design of other elements in the parkway to establish a visual character consistent with other parkway amenities.
- Major gateways shall be vehicular-scaled, but they should also function at the pedestrian scale by providing a pedestrian-friendly experience.
- Major gateways should not only feature signage, but should also incorporate additional enhancements such as plantings, flags, and sculpture in order to heighten the entry experience.
- Structural elements should be situated behind required minimum setbacks.
- The location of signs and plant materials must not obstruct the motorist’s view of oncoming traffic. Local regulations shall be reference in the final design phases to ensure sight distances.

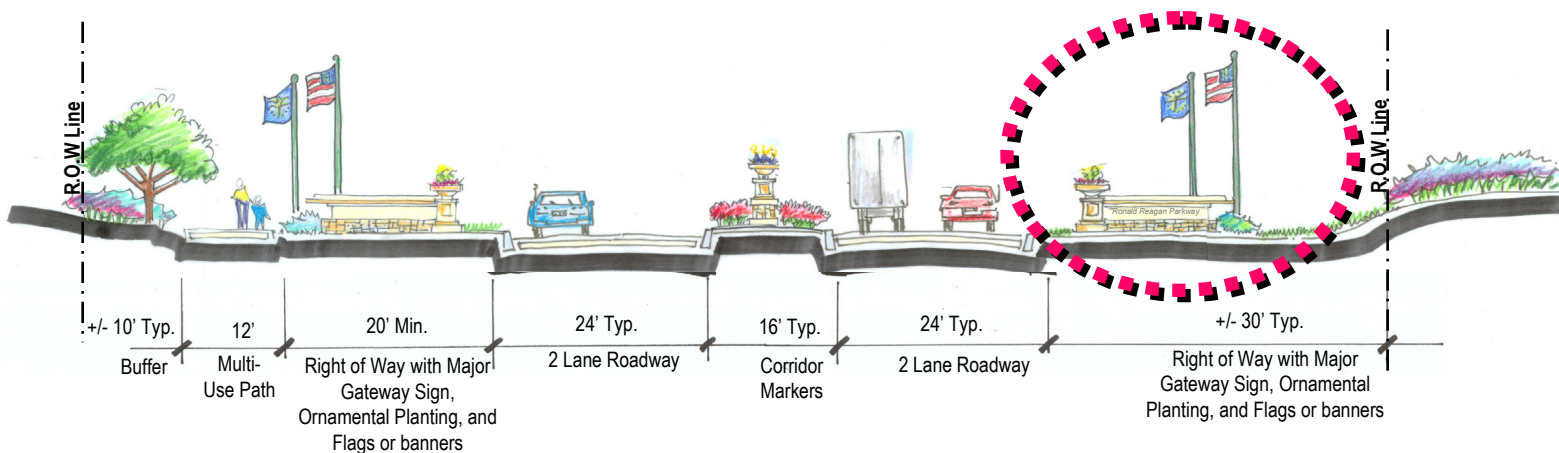

FIGURE 6.23: Major Gateways Section

Corridor Gateway Markers

Corridor gateway markers are utilized in order to further express the gateway concepts for the Parkway. They are utilized as sequential vertical elements, appearing along the parkway and unifying the sequence of spaces and land uses along the corridor at periodic intervals. These corridor markers are featured in the median at gateway areas, establishing a hierarchy of gateways and entries. The corridor markers reflect the same palette of materials utilized in the major gateway signs. The markers consist of planters resting on vertical stone columns that are aligned within the median. Once again, these markers reflect a palette of neutral stone materials that is reflected in numerous gateway features and design elements throughout the parkway. They truly act as “markers” for the corridor by integrating the parkway logo into the design of the column. An example of a typical corridor gateway marker and its application along the Parkway is shown in FIGURES 6.24 and 6.25.

- Corridor markers should incorporate natural stone materials. The style and materials of corridor markers should be coordinated with the design of other elements in the parkway to establish a visual character consistent with other Parkway amenities.
- The Parkway logo should be integrated into corridor markers.
- Corridor markers should be located within medians.
- Corridor gateway markers should be highlighted by special accent plantings.

Corridor Marker Guidelines

- Corridor markers should be utilized in the median to highlight key gateway areas.
- The location and height of corridor markers cannot obstruct the motorist’s view of oncoming traffic. Local regulations should be referenced in the final design phases to ensure sight distances.

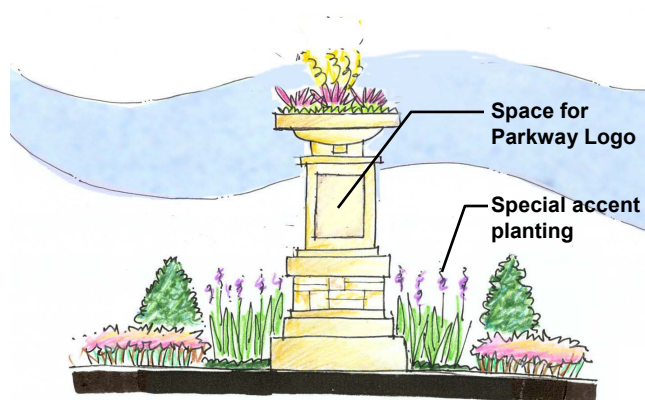

FIGURE 6.24: Typical Corridor Marker

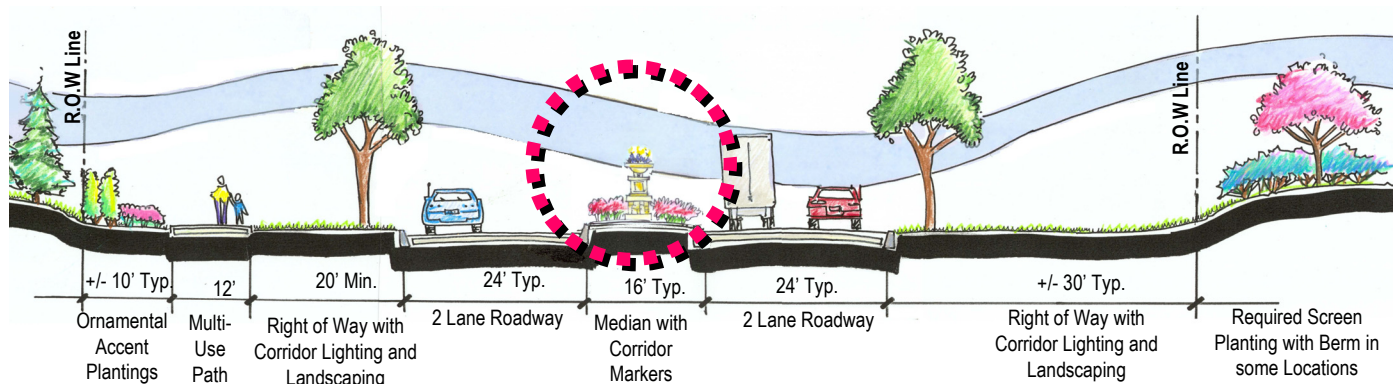

FIGURE 6.25: Corridor Markers

RONALD REAGAN

Corridor Master Plan

Secondary Gateway Signs

Secondary gateway signs are utilized to mark entry to specific destinations. The purpose of establishing guidelines for secondary gateway signs is to provide a palette of design material for the design of individual signs along the corridor. The use of a consistent sign palette along the entire corridor will reduce visual clutter along the parkway and further reinforce the parkway's identity. The intent in providing examples of development/destination signage is not to stifle creativity in design, but to encourage individual property owners to utilize like materials in the design of signs that are located along parkway frontage. The use of similar materials will establish a visual harmony along the entire length of the Parkway. **FIGURES 6.26 and 6.27** illustrate a typical secondary gateway sign and its application to the corridor.

Secondary Gateway Sign Guidelines

- Secondary Gateway signs should be utilized to mark entry to public and private establishments.
- The location and height of secondary gateway signs cannot obstruct the motorist's view of oncoming traffic. Local regulations shall be reference in the final design phases to ensure sight distances.
- Signs should incorporate natural stone materials in a manner that is consistent with other gateway signage.
- All signs should be highlighted by special accent plantings.
- Unified development signs are encouraged in commercial areas.



FIGURE 6.26: Typical Secondary Gateway Sign

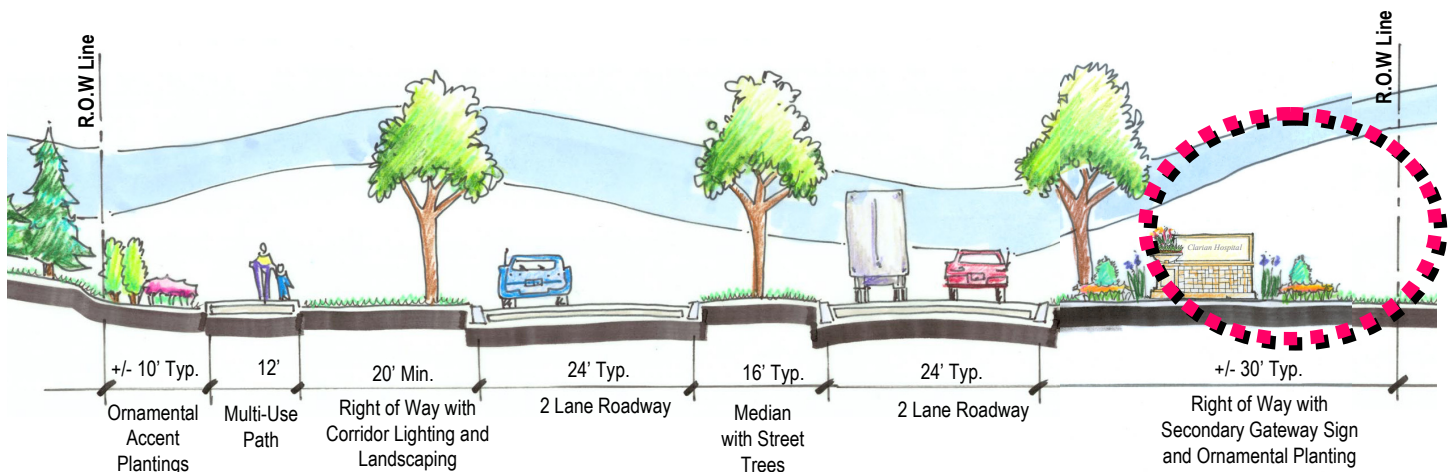

FIGURE 6.27: Secondary Gateway Signs

Intersection Enhancements

The level of treatment that was selected by the steering committee for theming was that of a moderate treatment utilizing traditional streetscape materials. Therefore, the recommended intersection design features traditional streetscape enhancements with some moderate thematic treatment.

Intersection treatments are important to the overall safety and aesthetics of the corridor. Roadway crossways create a memorable impression to every motorist that passes through or stops at a red light. Every intersection should be treated as a special entry onto the Parkway.

The design of intersection enhancements should be coordinated with other elements along the parkway to convey a consistent image at all vehicular entry points along the corridor. It is recommended that ornamental signal poles be utilized at intersections. These poles should match the style of poles selected for the Parkway lighting. In addition, the parkway medallion is incorporated into signal poles as well as light poles to further identify the Ronald Reagan Parkway at intersections. At gateway areas, decorative paving should be utilized to mark crosswalks. Where appropriate, the use of accent plantings is recommended at gateway intersections. The use of these enhancements will convey a welcoming message to all entering the Parkway, whether as pedestrians or motorists.

Intersection Enhancement Guidelines

- All intersections along the Parkway shall utilize the same style and color of signal poles and should convey a consistent character.
- Crosswalks should be marked at all intersections. Decorative paving should be utilized at crosswalks in major gateway areas.
- Pedestrian signals shall be utilized at all crosswalks.

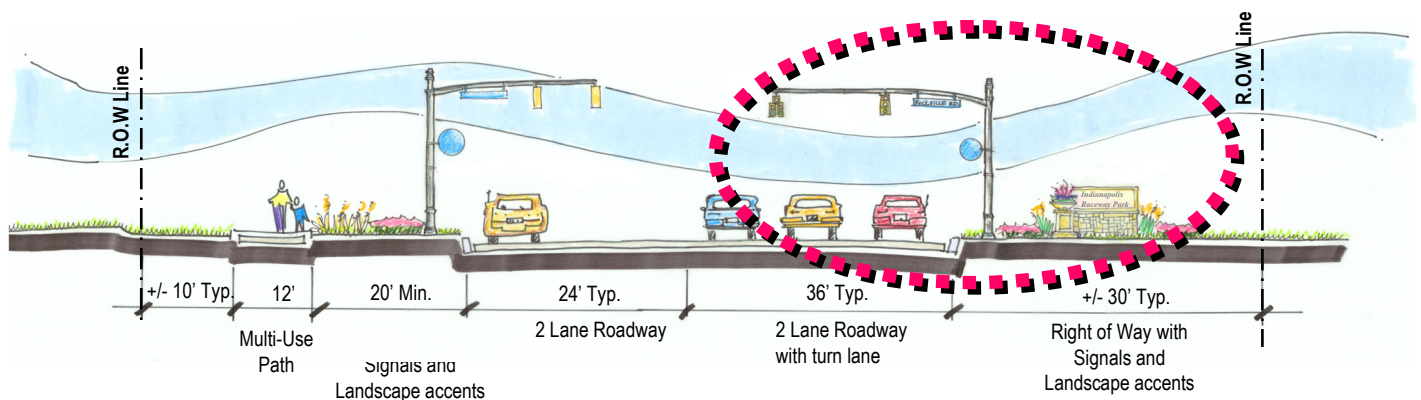

FIGURE 6.28: Intersection Enhancements

RONALD REAGAN

Corridor Master Plan

Summary of Gateway Treatments

The map to the right in **FIGURE 6.29** demonstrates the application of gateway elements to the corridor. Special gateway treatments help to establish a memorable impression of the Parkway and communicate a positive welcoming message to all who travel through it. Gateways elements are one of the singlemost important features in establishing a unique identity for the corridor. Major gateway features are recommended at I-70 and I-74. Major intersection should be treated as secondary gateways. Corridor markers and specialty signage utilizing the same palette of materials will help to link the gateways along the entire length of the Parkway. The utilization of all of these elements will help set the Ronald Reagan Parkway apart as a truly unique corridor within Hendricks County and the entire region.

- Gateway Treatments Summary:**
- Specialty Wall and Signage treatment and thematic enhancements at major gateways
 - Corridor markers and specialty signage at major intersections and key destinations
 - Special intersection enhancements including ornamental signal poles and pedestrian crosswalks.

Legend:

- Ronald Reagan Pkwy (Planned)
- Ronald Reagan Pkwy (Constructed)
- Major gateway opportunity
- Potential Specialty Signage For Key Destinations
- Opportunity for Special Intersection Treatments at Secondary Gateways

FIGURE 6.29: Gateway Elements

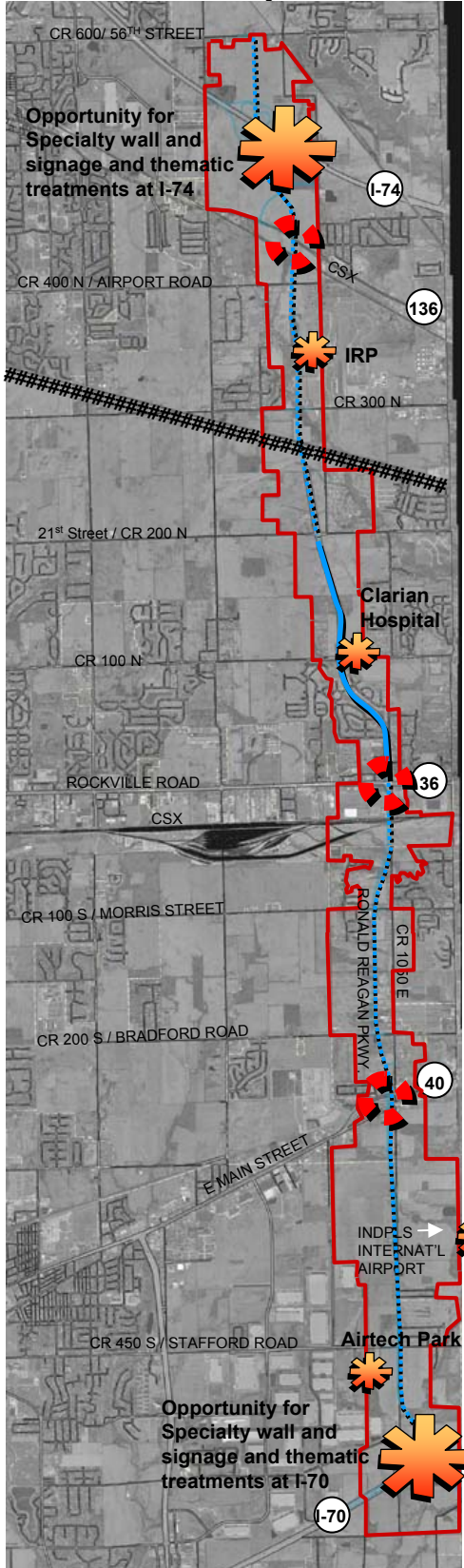

WAYFINDING ELEMENTS

Design Intent: to provide a uniform system of directional and informational signage that facilitates wayfinding and assists visitors and Parkway users to clearly find attractions, lodging, and parking areas while also communicating the unique identity of the corridor.

The primary purpose of wayfinding signage is to direct visitors to particular destinations. A wayfinding system is an important component of the parkway design, and contributes to both the function of guiding travelers to their destinations and the visual identity of the parkway. Wayfinding signs help to direct vehicles to specific public destinations. They also enhance the image of the parkway and help to communicate its identity. In addition, well-designed wayfinding signs should communicate a welcoming message to visitors and help to make their experience more memorable. With the direct relationship of the Indianapolis International Airport to the corridor, the need for wayfinding signs is even more justified. It is especially important that these signs facilitate wayfinding and assist travelers and Parkway users to clearly find attractions, lodging, and parking areas with minimal confusion.

Themed Corridor-Specific Wayfinding System

In the alternative design concepts exercise, the steering committee was presented with optional types of wayfinding signage treatments. The options presented included a minimal level treatment that depicts standard signage only, one that also includes directional signage, and a more aggressive approach which shows a themed corridor-specific wayfinding system. The consensus adopted by the committee is the establishment of a themed corridor-specific wayfinding system. **FIGURE 6.30** represents a typical image of this type of system that the steering committee selected. The steering committee was in favor of the more aggressive approach that utilizes theming, colors, and form to enliven the design of the sign. This approach will help to provide an additional cue that will enable visitors to recognize the corridor, and will help to convey a positive message about its identity.



FIGURE 6.30: *The image above was selected by the steering committee as a model for the desired type of signage along the parkway.*

A typical wayfinding sign and its application to the corridor section is shown on the following page in **FIGURE 6.31**. The sign is illustrated as a single-post with panels that provide directional information to at least four destinations. In addition, a medallion has been designed into the sign as a space for a parkway logo. It is recommended that a signage branding exercise be conducted in order to establish a parkway icon that can be utilized on the wayfinding signs as well as on other elements such as gateway monument signage. These graphics would help to carry out a parkway theme. Future branding exercises would help to further guide the design of graphic design elements that can be applied to other streetscape elements, such as colors, icons, fonts, etc. In addition to the wayfinding signs described, destination-specific wayfinding signs may be utilized to direct visitors to specific destinations such as the Indianapolis International Airport. An example of this type of sign is shown in **FIGURE 6.32**.

RONALD REAGAN

Corridor Master Plan

Wayfinding Signage Guidelines

- Signs should be designed as an entire system (not as separate signs), utilizing the same background color, layout, color-coding, parkway icon, pole design, etc.
- The parkway logo, icon, or name should be utilized on the wayfinding sign as a means for establishing parkway identity.
- Destinations listed on wayfinding signage should be a fixed facility or site.
- Placement of a destination shall be name only, and advertisements should not be permitted. Specific destinations eligible for inclusion should be determined by the County.
- All signs should be placed in the public right-of-way. When possible, signs should be placed on the near side of an approaching intersection to the right. This placement will reinforce to drivers that they are being directed to make a turn at the nearest intersection.
- Sign locations should not interfere with pedestrian accessibility.
- Signs should have a minimum clearance of at least 80" between the overhead sign and the ground plane.
- Typestyle characters should be designed to be visible from a car while traveling. Characters should be uppercase sans serif typestyle, and should be at least 5" high.
- Background finish should be eggshell, matte, or other non-glare finish and colors must adequately contrast with type for readability.

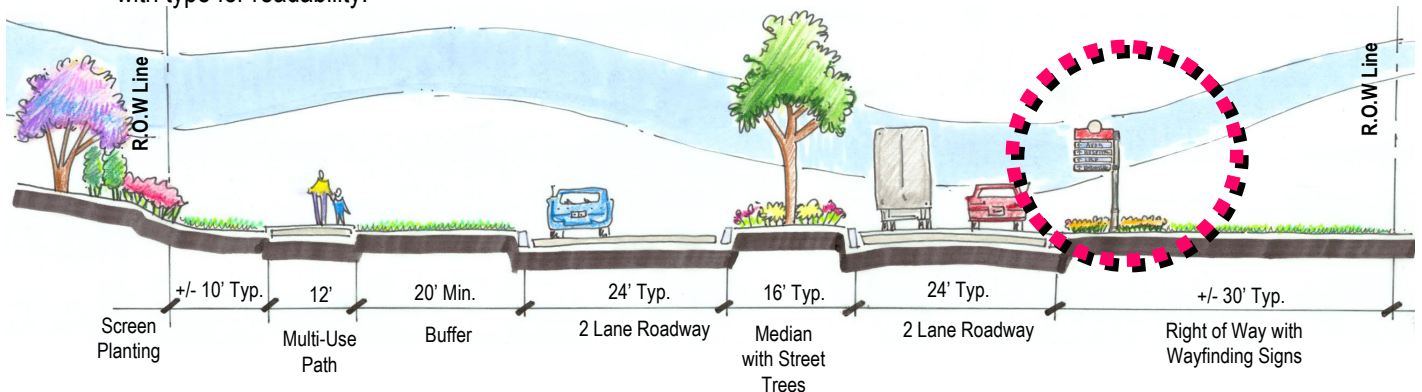

FIGURE 6.31: Wayfinding System

In addition, destination-specific wayfinding signs and street signs should be designed to coordinate with wayfinding signs. The coordination of all wayfinding signs along the Parkway is important to establishing a strong visual identity and aesthetic for the corridor. Some examples of signage that should be coordinated with the traditional wayfinding signs are shown in FIGURE 6.33 and 6.34.

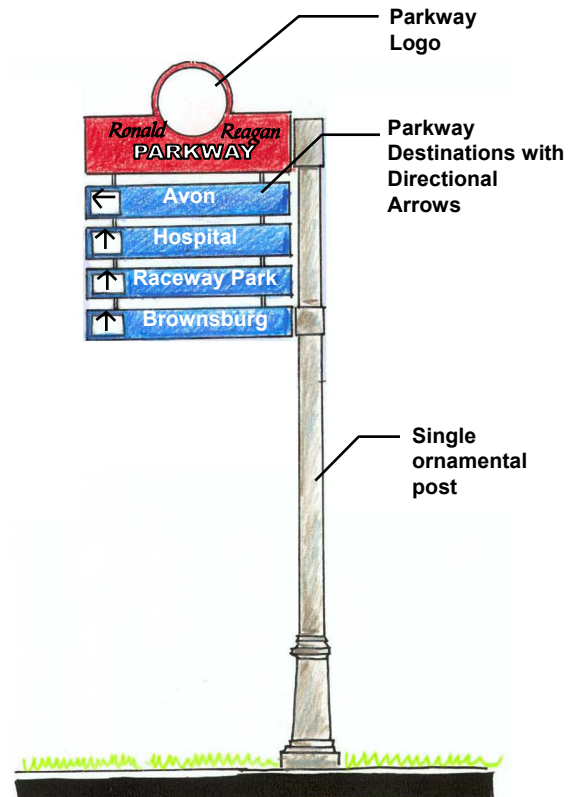

FIGURE 6.32: Typical Wayfinding Sign

Summary of Wayfinding Signage Treatments

Wayfinding signs allow parkway users to clearly find attractions, lodging, and parking areas with minimal confusion. They also enhance the image of the parkway and help to communicate its identity. The goal of the wayfinding system is to provide a uniform system of information that also reinforces the unique identity of the corridor. The map to the right in **FIGURE 6.35** demonstrates the application of wayfinding signage to the corridor. Wayfinding signs are recommended in highly-trafficked locations, and should be spaced at intervals between 1 to 2 miles. The following map demonstrates the application of wayfinding signage to the corridor. Wayfinding signs are recommended in highly-trafficked locations, and should be spaced at intervals between 1 to 2 miles.

Wayfinding Signage Treatments Summary:

- Themed Corridor-specific wayfinding system throughout corridor
- Destination-specific signs at key locations
- Coordinated streetsigns

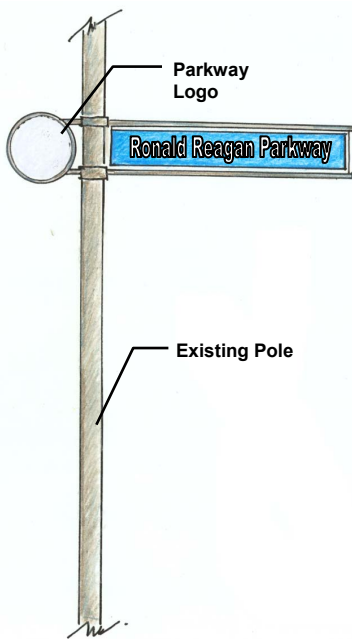

FIGURE 6.33: Coordinated Wayfinding System – Street Sign

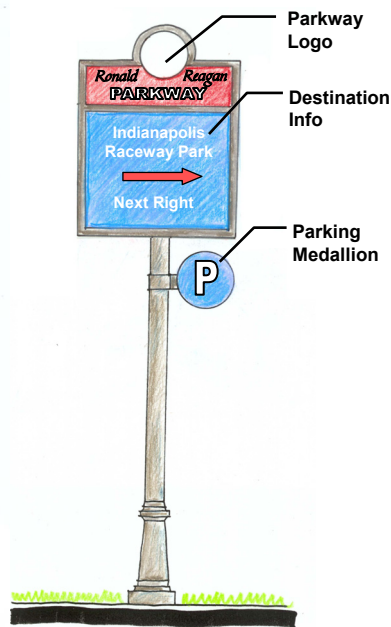
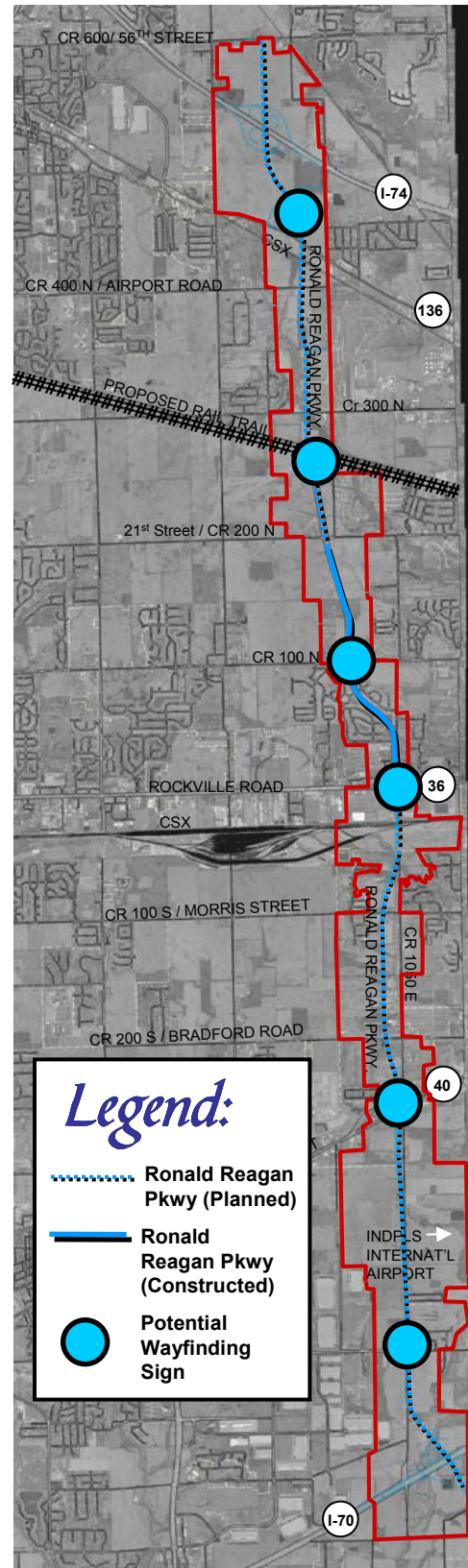

FIGURE 6.34: Coordinated Wayfinding System - Destination Specific Wayfinding Sign

FIGURE 6.35: Corridor Application: Wayfinding Signage



STRUCTURAL ELEMENTS

Design Intent: to design structural elements not only as functional amenities, but to introduce a high level of design into all structural elements, reinforcing the Parkway's status as a premier business address and creating an exciting visual experience for motorists and pedestrians.

Structural elements including bridges and walls play a major role in the image that a roadway is likely to portray. The monumental scale of major bridges makes a tremendous impact on the look and feel of the built environment. This plan recommends an enhanced level of treatment for structural elements, further reinforcing the corridors image as a premier location.

For purposes of this study, bridge elements were divided into major bridges and minor bridges. These designations were based solely on their visibility from other infrastructure.

Major bridges are highly visible from other major infrastructure most notably other roadways. This results in an increased attention to detail of the design of these bridges, both to and from the bridge.

Minor bridges were designated for bridge treatments with little or no public view. An example of this is the railroad crossing where only trains can view the design of the bridge. In these instances, design treatment is minimalized to areas visible from the corridor.

These designations apply only to aesthetic topics of this study and do not indicate level of structural design in any way.

Major Bridge Treatments

In the alternative design concepts exercise, the steering committee was presented with optional types bridge treatments. The options presented included a minimal level treatment, an enhanced wall treatment at bridges, and the most aggressive approach, the development of signature bridges. While some of the steering committee favored the development of signature bridges, the majority was in favor of a more moderate approach that utilizes enhanced wall treatments. **FIGURE 6.36** represents the image of this type of enhanced wall treatment selected by the steering committee.



FIGURE 6.36: *The image above shows enhanced treatments on bridges, a corridor aesthetic selected by the steering committee.*

Along its 12-mile path, bridges will be required to pass over I-74 and SR 136. These bridge crossings present the opportunity to convey an image not only from the parkway itself, but also from other major roadways. The illustrations in **FIGURE 6.37 and 6.38** and **FIGURE 6.39. and 6.40** depict the recommended bridge enhancements.

As shown in these illustrations, enhanced wall treatments on bridges establish a strong link with the design of other parkway materials. A palette of natural colors and materials further reinforces the Parkway's aesthetic. In addition, the Parkway name is integrated into the bridge overpass, signifying the importance of the Ronald Reagan Parkway and orienting motorists to its location. Bridge piers are stylized to create a signature statement as motorists pass under the Ronald Reagan Parkway.

Bridges are composed of special design features which also include corridor lighting integrated into the bridge design, a decorative railing to protect pedestrians, and decorative planters integrated into piers. In addition, retaining walls of natural materials and colors may be utilized to soften the grade changes at bridge areas. Large open areas at bridges should feature special plantings.

These bridge enhancements have a vital impact from below. From the pedestrian level of those passing over the bridge from the Parkway, the lighting, railing, and ornamental planters further enhance the pedestrian experience, providing safety and elements of comfort. The multi-use path shall continue along the bridge in order to reinforce pedestrian connectivity along the entire length of the Parkway.

Major Bridge Guidelines

- Bridges at I-74 and SR 136 shall receive major bridge enhancements. These include the following: enhanced wall treatments, parkway signage visible from underpass, corridor lighting, decorative railing, decorative planters, and special plantings.
- Major bridges must integrate corridor lighting into their design in order to provide a well lit roadway and a safe pedestrian environment.
- The multi-use path shall continue along major bridges, and shall be at least 12' wide in order to provide safe crossing for pedestrians.

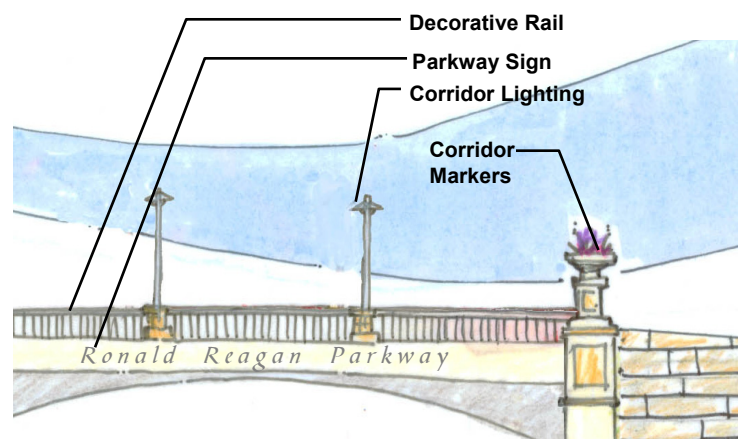

FIGURE 38: Detail of Special Bridge Enhancements

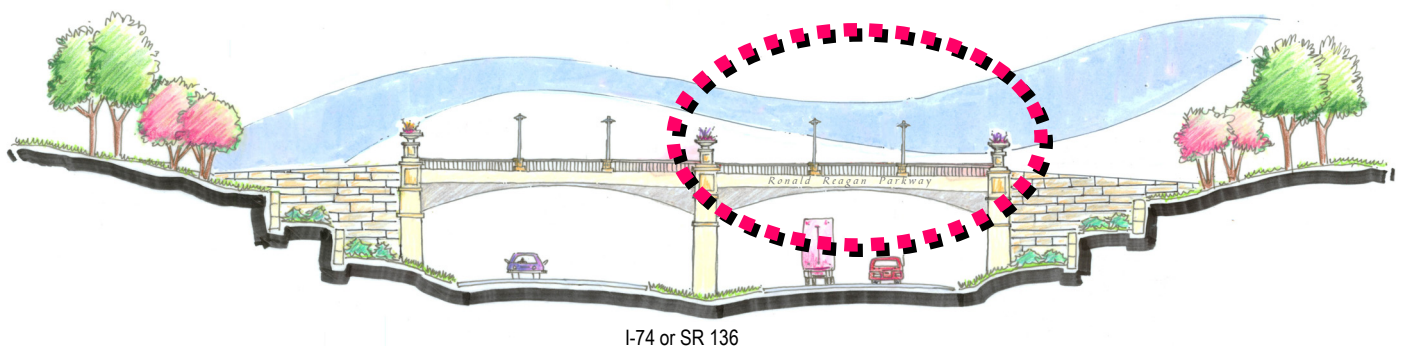

FIGURE 6.37: Major Bridge Treatment - Views to Corridor

RONALD REAGAN

Corridor Master Plan

Minor Bridge Treatments

A minor bridge is located where the Parkway crosses the CSX Railyard. This bridge shall be designed in a manner consistent with the major bridges, utilizing the bridge elements that are visible from the Parkway as described for major bridge treatments. These include parkway lighting integrated into bridge structures, pedestrian railing, ornamental planters, and a pedestrian path. The views from the perspective of the railroad are not a high priority, and therefore no special wall enhancements or further treatments are necessary from the perspective visible only from the railroad.

Minor Bridge Guidelines

- The bridge over Conrail shall receive minor bridge enhancements. These include the following elements: corridor lighting, decorative railing, decorative planters, and special plantings.
- Minor bridges must integrate corridor lighting into their design in order to provide a well lit roadway and a safe pedestrian environment.
- The multi-use path shall continue along the bridge, and shall be at least 12' wide in order to provide safe crossing for pedestrians.

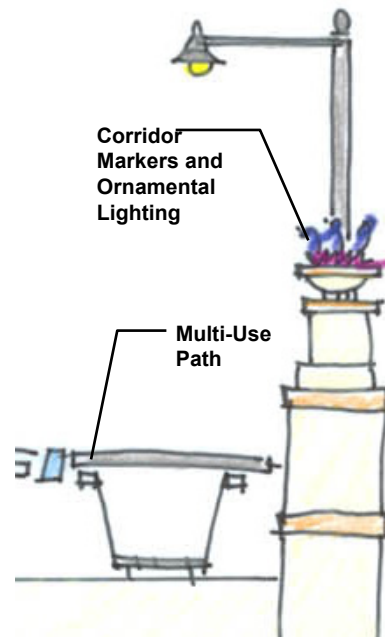

FIGURE 6.40: Detail of Special Bridge Enhancements

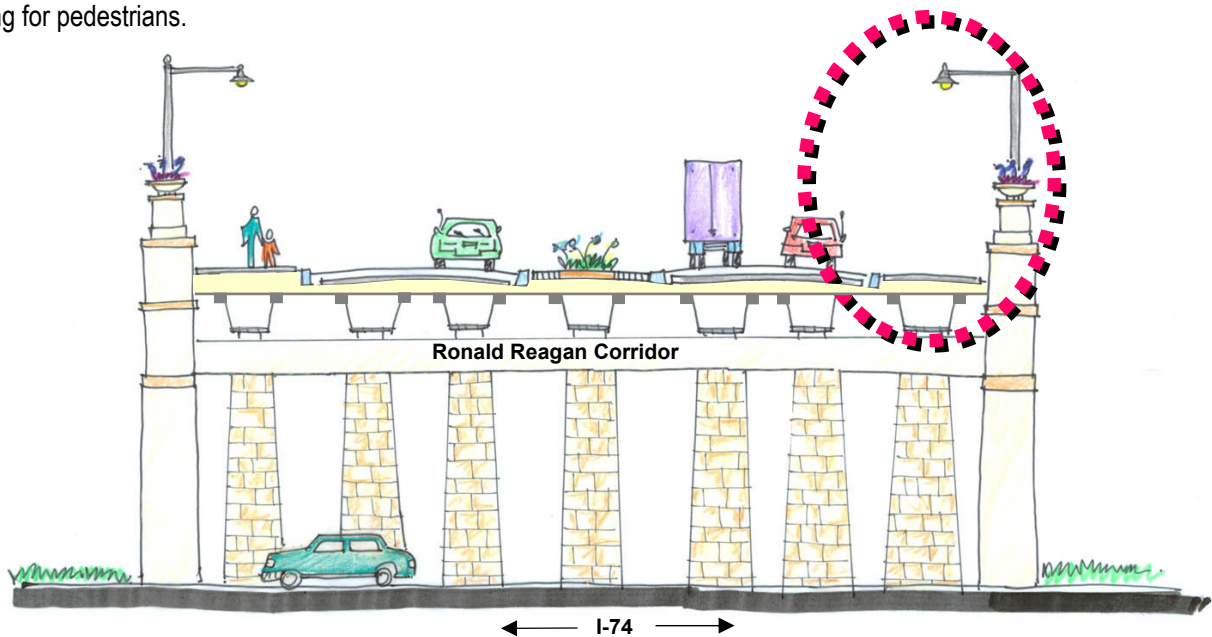

FIGURE 6.39: Bridge Treatments—Cross Section of Corridor

Wall Treatments

The options that the steering committee selected from included a concrete wall, a rustic wall made of natural materials, a specialty wall, and enhanced wall treatments such as relief sculpture. A moderate to aggressive approach was also selected for wall treatments. The image selected depicted a specialty wall of concrete or natural materials. This image is shown in **FIGURE 6.41**.

Retaining walls and bridge abutments provide the unique opportunity to further enhance the character being established in the other design elements. Retaining walls may be utilized in various locations along the corridor, including entries to private developed parcels, whether at industrial sites to residential developments. Special wall treatments should also be considered for use at major gateways, not only along the Parkway, but also in areas that announce the Parkway. One example is the overpass at I-74. Not only are bridge enhancements recommended here, but retaining walls may also be utilized in this location to enhance the visual experience of the Parkway from I-74.



FIGURE 6.41: *Specialty wall treatments, as shown in the photograph above, are desired along the parkway.*

Where necessary retaining walls should be designed as specialty walls that match the look and aesthetic of other elements in the corridor by the use of similar materials. Walls should use muted earth tones that coordinate with gateway signage. In addition, special attention should be given that the walls reflect the natural character that is desired as the overriding landscape theme for the parkway.

Wall Guidelines

- All retaining walls along the parkway shall utilize similar materials that match the palette of muted earth tones selected for the Parkway.
- All walls shall be of structurally sound construction.
- The use of retaining walls and special wall treatments is encouraged at entry drives.

Summary of Structural Elements

The map at the right in **FIGURE 6.42** shows the application of structural elements to the corridor. Special bridge treatments at I-74 and SR 136 as well as a minor bridge treatment over the CSX Railyard will reinforce the Parkway's status as a premier business address. In addition, the utilization of specialty wall treatments at bridges and private entry drives will further contribute to the Parkway's design aesthetic.

Structural Elements Treatments Summary:

- Special bridge treatments at major bridges including I-74 and SR 136.
- Minor bridge treatment over CSX Railyard includes elements visible from the Parkway
- Special wall treatments at bridges, and private entry drives

FIGURE 6.42: Corridor Application: Structural Elements

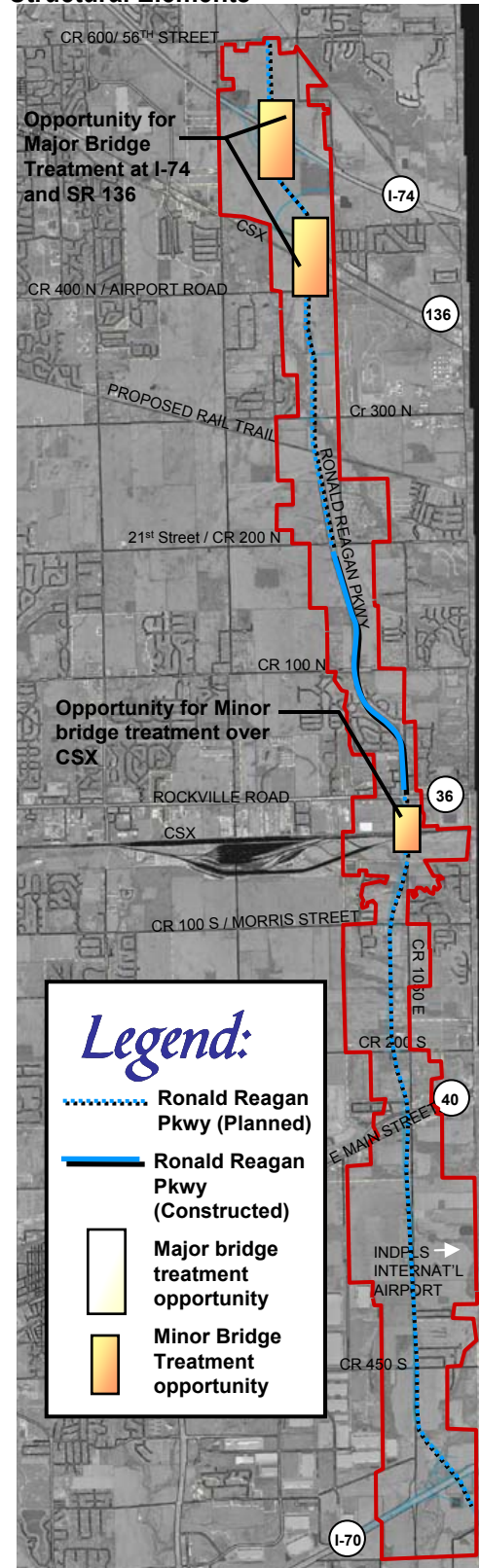

PEDESTRIAN AMENITIES

Design Intent: to promote a pedestrian-friendly environment along the entire length of the corridor that enables pedestrians to travel freely and safely and rewards pedestrians for the choice to walk.

Pedestrian amenities are integral to the overall transportation network within and beyond the corridor. Not only do these amenities play an important role in establishing a pedestrian-friendly environment, but they are crucial in establishing connectivity and a multi-modal facet within the regional transportation network. Providing multi-modal transportation has become a priority in the Indianapolis MSA as the region grapples with federal non-attainment and increasing ozone levels. Pedestrian and bicycle facilities have become a mainstay in Indiana, fueled by an interest in smart growth and livable communities. A renewed emphasis on walking and its benefits, for health, economic, and environmental reasons, has placed pedestrian access and amenities on the priority list for many communities. It is now the norm rather than the exception to incorporate pedestrian-friendly features into new roadway construction. INDOT now incorporates sidewalks, separated bicycle-pedestrian paths, and other pedestrian features into many of its projects in order to accommodate both pedestrians and cyclists.

In order to establish the Ronald Reagan Parkway as a premier address in the local region, it is critical that safe and convenient access and high quality pedestrian and bicycle amenities be integral to the plan of the corridor. Continuous pedestrian ways and safe crossings are the basic building blocks for pedestrian safety. This corridor is even more profoundly affected by the local pedestrian network because it is crossed by the B&O Trail. When complete, the B&O trail will be about 55 miles long and permit non-motorized travel from Speedway in Marion County, through Hendricks and Putnam Counties, to the Wabash River in Parke County. This crossing provides a unique opportunity to connect the Ronald Reagan Parkway to the regional trail network at the B&O Trail.

In addition, the extensive right-of-way allows the opportunity to create a 12-mile greenway along the corridor that further connects the communities along the route.



FIGURE 6.43: *The inclusion of a multi-use path is desired along the parkway.*

Multi-Use Path

In the alternative design concepts exercise, the steering committee was presented with optional types of pedestrian paths in order to determine their preferred level of treatment for pedestrian amenities. The options presented included a minimal level treatment of sidewalks only along the corridor, moderate treatments including an on-street bike lane and a multi-use bike and pedestrian trail along the corridor, and a more aggressive approach which utilized a trail separated from the roadway by heavily planted buffers and fences. The steering committee selected an above average level of treatment, that utilizes a multi-use bike and pedestrian trail along the corridor. **FIGURE 6.43** represents the image of this type of prototypical trail selected by the steering committee.

As a result of this exercise, a new multi-use path will be included in the roadway design along the entire 12-mile length of the corridor to provide an attractive and safe mode of transportation for pedestrians and cyclists. This path should be detached from the roadway in order to provide a safe pedestrian zone that is buffered from the street. The detached path is strongly preferred because it enhances the beauty and safety of the right-of-way.

RONALD REAGAN

Corridor Master Plan

Multi-Use Path Guidelines

- A high quality pedestrian environment will be developed as the foundation of the desired multimodal transportation system along the Parkway.
- A multi-use path should continue the entire length of the corridor on at least one side of the roadway, providing a continuous pathway for the pedestrian in order to insure safe pedestrian connections. The recommended width of the multi-use path is 12' wide, with typically at least 20' buffer between the path and the street. In areas where the path extends on only one side of the roadway, a 6' sidewalk shall be required along the opposite side.
- Pedestrian pathways should provide an adequate amount of light for the safety of users. This includes the use of pedestrian-scaled lighting that reflects the character of the corridor.
- The County and/or local municipalities should ensure that all projects connect with and/or help to complete an overall corridor network not only within the corridor, but also establish external connections to other existing and proposed pedestrian paths.
- The use of special, decorative paving or tactile surfaces is encouraged at curb ramps and intersections to separate the street at pedestrian crossings.
- Mid-block pedestrian crosswalks are discouraged.
- Curb ramps should be provided to accommodate wheelchairs, bicyclists, and strollers. To the maximum extent possible, the trail should be accessible to people with disabilities. A wheelchair user should be able to move safely and conveniently through the parkway.

- To aid pedestrian navigation and comfort, the following elements are encouraged along the walkway in high-pedestrian activity areas: shade trees, landscaping, pedestrian-scaled lighting, water fountains, and seating and resting spots.
- Pocket plazas associated with commercial and industrial uses are encouraged to establish links with the multi-use path. A reduction in the number of parking spaces required shall be permitted in instances where parks/plazas are included in the site design.

Trail Crossings and Linkages

Trail crossings and linkages are important because they establish connections with the regional pedestrian network. Safety is of utmost importance, and should be the highest priority in determining the treatment for all intersections and trail crossings. Marked crosswalks are a basic design treatment, and should be utilized at all signalized intersections. They are strongly encouraged at unsignalized intersections as well.

The crossing at the future B&O Trail requires special attention in order to provide the highest standard of safety. In addition, it provides a unique opportunity to connect the Ronald Reagan Parkway to the regional trail network. A pedestrian /bicycle tunnel is planned for this important trail crossing. It is recommended that the tunnel be integrated into the overall design scheme for the parkway. Typical proposed enhancements include special wall treatments, ornamental lighting within the tunnel, and engraved markings at the tunnel entrance. Additional opportunities for public art features at this tunnel should be explored.

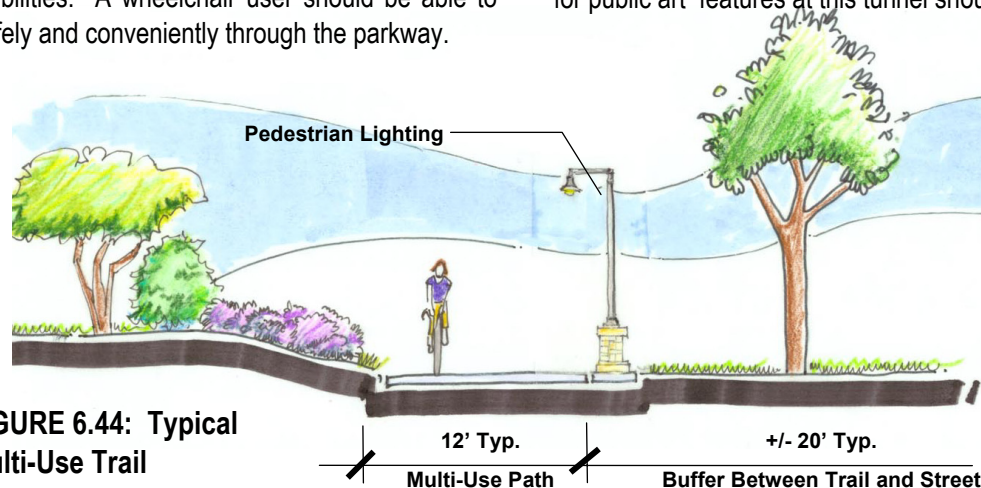

FIGURE 6.44: Typical Multi-Use Trail

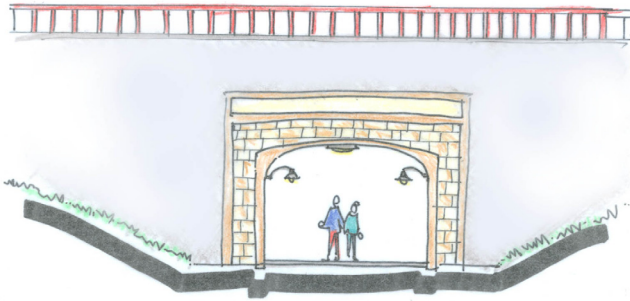

FIGURE 6.45: Potential Enhancements at B&O Rail-Trail Tunnel

Another potential trail crossing occurs at the intersection of the Ronald Reagan Parkway and US 40. The Vandalia Rail-Trail concept is an effort to link to the National Road Heritage Trail by establishing a continuous local trail Connection from Plainfield to Greenfield, passing through Indianapolis trail networks. Preliminary concepts for this trail have been discussed, and the intersection of US 40 or the Old National Road may become an important pedestrian crossing, as well as provide a future link to the B&O corridor via the multi-use path along the Ronald Reagan Parkway. This trail crossing would help to further establish pedestrian connectivity, both at a local and regional scale.

It is recommended that special crossing features be utilized at the Vandalia Rail Crossing, including enhanced pavement markings and bicycle route signage. In addition, the County should consider using crossing enhancement technologies in order to ensure the highest level of safety for pedestrians and cyclists.

Trail Crossings and Linkages Guidelines

- All signalized intersections shall utilize marked crosswalks, and enhanced treatments such as the use of decorative pavers. Tactile surfaces at curb ramps are strongly encouraged.
- Non-signalized intersections are strongly encouraged to utilize marked crosswalks.
- Pedestrian Tunnels should receive special enhanced treatments that utilize materials and design elements in keeping with the parkway theme.

• Linkages should be made with existing and proposed trails that connect to the corridor. These include but are not limited to: the proposed Brownsburg Trail, the proposed Avon Creek Trail, the Vandalia Rail-Trail, and the Stafford Road Trail.

Summary of Pedestrian Amenities

The map to the right in **FIGURE 6.46** shows the recommended application of pedestrian amenities to the corridor. The corridor has the opportunity to connect to the regional trail network and other local trails. This plan reinforces the importance of encouraging these linkages and of establishing a pedestrian friendly parkway. The aim of the plan is to provide a continuous pedestrian network along the corridor in a safe and convenient manner. The inclusion of a multi-use path along the corridor length is crucial to meeting the needs of local pedestrians and cyclist, both for recreation and as an alternative mode of travel.

Pedestrian Amenities Summary:

- 12' multi-use path along entire corridor, 1 side of roadway
- Marked crosswalks at intersections
- Potential Trail Linkages at Proposed Brownsburg Trail, Proposed Avon Creek Trail, and Stafford Road Trail
- Future Rail Trail Crossing at B&O Corridor

FIGURE 6.46: Corridor Application-
Pedestrian Amenities

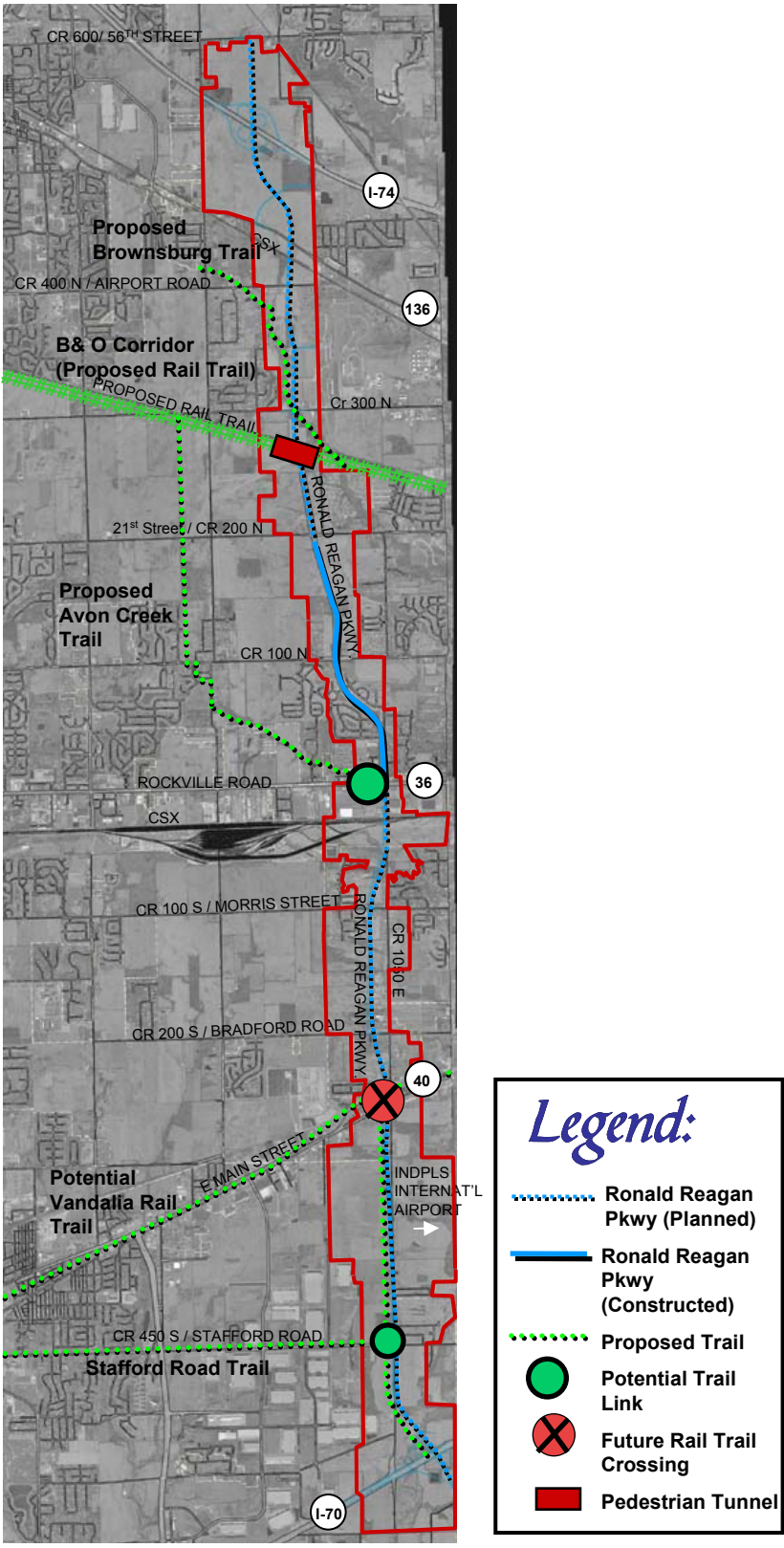

CORRIDOR UNIFICATION

The design enhancements establish a unified look to the entire corridor. The design guidelines presented here provide a framework for creating a cohesive set of amenities that help establish a rich and unique character to the corridor and ties the corridor together visually. The enhancements provide a “visual infrastructure” that is equally important to the physical roadway infrastructure in meeting the goals of the project.

Although the physical enhancements provide a solid theme to the corridor, there are simple steps that can be taken to enhance the aesthetic even further without significant additional construction expense. The addition of these theme elements will further create a solid identity for the corridor. **FIGURE 6.47** illustrates the consistency in materials between the recommended design elements.

Consistency of Materials

The enhancement concepts illustrate a consistent use of materials and craftsmanship throughout the entire set. If viewed together, a family of enhancements has been developed that can serve as a design standard throughout the entire corridor. This creates a basic level of treatment that should be applied to the entire corridor:

- Consistent stone material and construction methods should be used in the development of all gateway structures, wall treatments, and bridge treatments.
- If a specific design style is used in craftsmanship, it should be replicated throughout the corridor.
- A consistent set of pole standards should be used for all poles including light poles, signal poles, wayfinding poles, signage poles, and other poles throughout the corridor.
- A consistent standard should be established that follows the conceptual design guidelines outlined in this section.

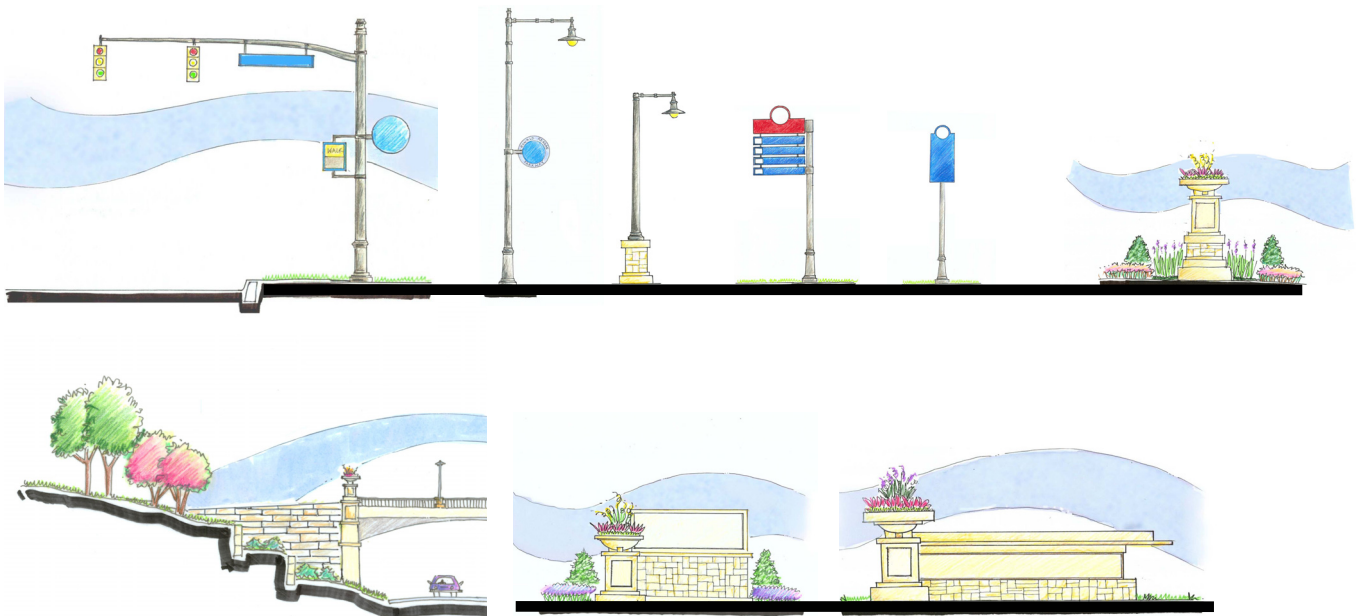

FIGURE 6.47: Consistent Aesthetic and Materials

RONALD REAGAN

Corridor Master Plan

Consistency of Color

A second additional treatment that could be considered that might further unify the visual theme of the corridor. The use of a specific color theme, unique to the corridor, would help further the visual unity of the corridor. For example, with its patriotic name, the Ronald Reagan Parkway could be developed using a theme of red or blue. **FIGURE 6.48** illustrates the potential use of red on all poles, rails, and other similar structures along the corridor. This treatment helps to create a unified look and adds to the unique character of the corridor.

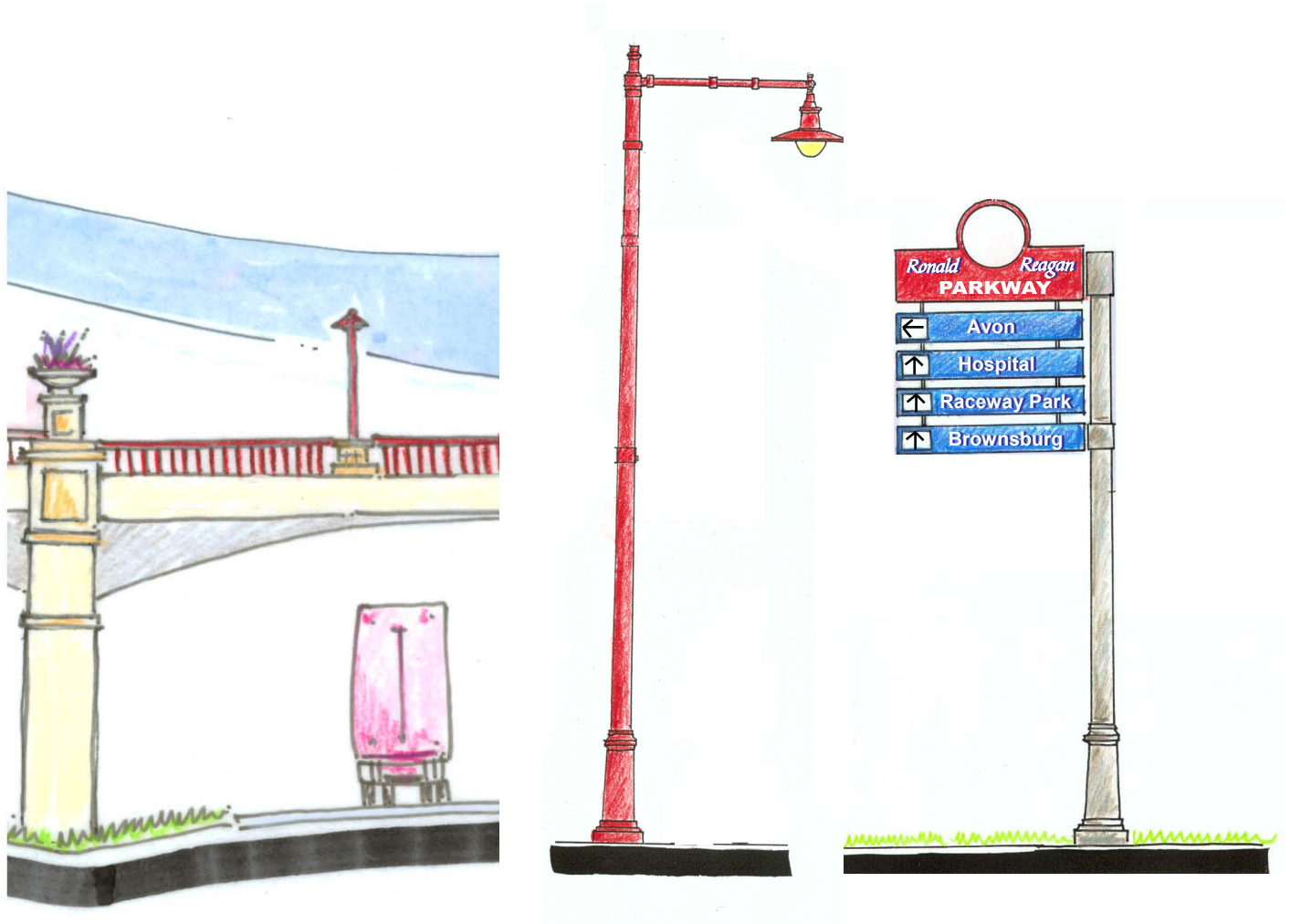

FIGURE 6.48: Consistent Color Theme

Application of Theme Imagery

A third additional treatment that could be considered is the development of a corridor “image.” This image would be unique to the corridor and would be added to all enhancements constructed along the corridor. As an example, **FIGURE 6.50** on the following page illustrates potential theme images that could be applied to the corridor. The examples shown range from patriotic flag images, to literal images of the roadway’s namesake, to a completely different theme (waves of grain) that could focus much more on the natural heritage of Hendricks County. Once an image was determined, it could then be added to the enhancements, as shown in **FIGURE 6.49**. This application further establishes the corridor as a unique place.

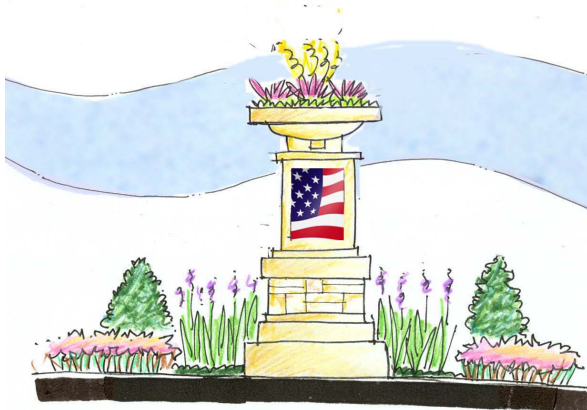
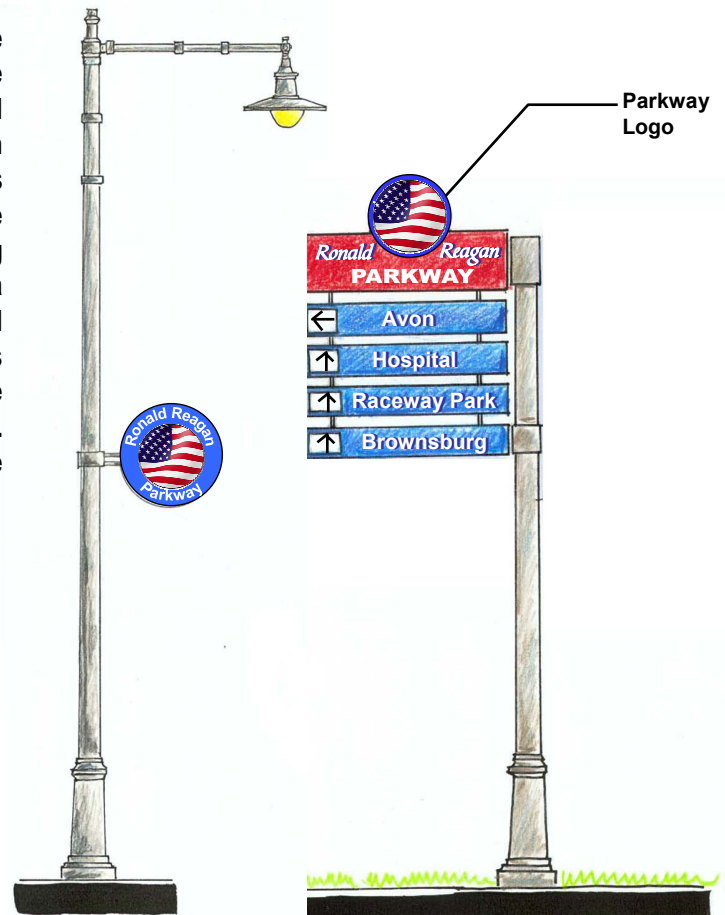
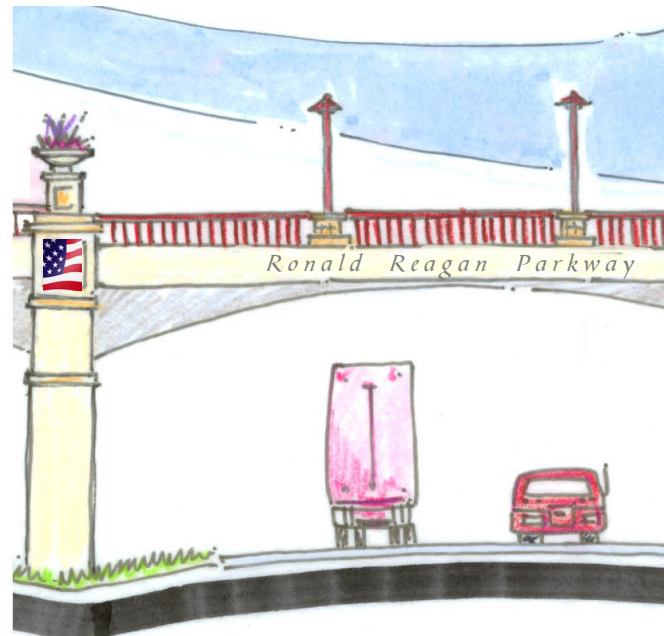

FIGURE 6.49: Application of Theme Imagery



RONALD REAGAN

Corridor Master Plan

CORRIDOR UNIFICATION RECOMMENDATIONS

The guidelines presented in this master plan are conceptual--they are intended to lead the design efforts as the Ronald Reagan Parkway is constructed. There are steps that are needed between these recommendations and the construction.

Corridor Image Branding Study

It is recommended that the County undertake a "branding" exercise to develop and select an image to represent the corridor and to be used on specific amenities. During this exercise, the extent of its usage should be determined--should it be used on wayfinding signs and light pole medallions only, or applied to the entire range of enhancements. This branding study will be important in solidifying the visual theme of the corridor.

Demonstration Project

There is a step between the conceptual design guidelines illustrated in this master plan and construction. Although this master plan sets the general direction for constructed amenities, a design development stage is needed in order to work out the detailing, select exact materials, determine exact dimensions, and to develop the conceptual sketch to a point where construction documents can be prepared.

It is recommended that the County undertake a demonstration project on one of the recently completed portions of the Parkway. The purpose of this project would be to further define the enhancements, prepare construction details, and construct the enhancements along a section of the roadway. This project would demonstrate the vision of the corridor and assist the County in building consensus for the overall vision of the corridor. This would also allow the county to develop the detailing that could then be applied to all future construction projects to insure a consistent application of enhancements.

The demonstration project would qualify for federal Transportation Enhancement funding. TE funding is an 80%-20% reimbursement program that provides funding to local communities for projects such as this. Awards generally are capped at \$1 million. If awarded, the County could implement a large portion of the demonstration project for only 20% of the cost. It is recommended that a portion of the Parkway be selected and a demonstration project be initiated that will showcase the full vision of the Ronald Reagan Parkway.

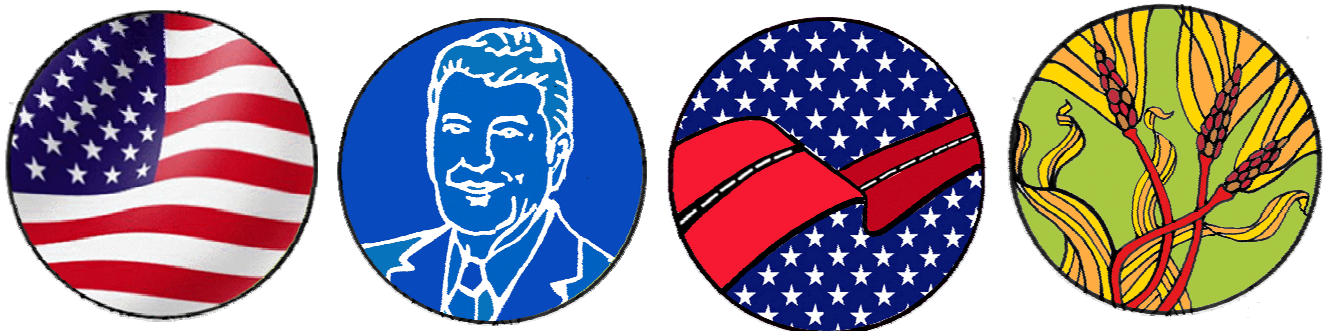

FIGURE 6.50: *Theme imagery can be applied to design elements within the parkway systems in order to create a special identity that celebrates a unique aspect of the corridor and local region.*

SAVAN

Section 7: Access Management

**Access Management Planning for the
Ronald Reagan Parkway**

WHAT IS ACCESS MANAGEMENT?

Access management is the systematic control of the location, spacing, design, and operation of driveways, median openings, interchanges, and street connections to a roadway. It also involves roadway design applications, such as median treatments and auxiliary lanes, and the appropriate spacing of traffic signals (Access Management Manual, Transportation Research Board, 2003).

In early meetings for the Ronald Reagan Corridor Master Plan, the steering committee and other stakeholders listed several items related to access management issues that are important to the newly designed parkway. The items that the public and stakeholders addressed as important to the function of the roadway included elements such as raised medians, minimal curb cuts, moderate setbacks, separated turn lanes, and sequence timed signals for traffic flow. In addition, other priority items included the discussion of a connection north into Boone County, access to communities via major arteries, the need to connect to the airport, and the possibility of a transit station.

All of these items relate to access management. This section defines access management as it affects the corridor and how its concepts can be best applied in the development of the Ronald Reagan Parkway.

“The purpose of access management is to provide vehicular access to land development in a manner that preserves the safety and efficiency of the transportation system.”

*Access Management Manual
Transportation Research Board*

DEFINITION & PURPOSE OF ACCESS MANAGEMENT

The purpose of access management is to provide vehicular access to land development in a manner that preserves the safety and efficiency of the transportation system (Access Management Manual, Transportation Research Board, 2003). Access management plays a critical role in the establishment of a well-functioning roadway, and is especially important when building new roads. The implementation of access management recommendations for the parkway will result in a roadway that functions at its optimal level.

Access management involves the physical layout, operations and institutional control of a roadway. The Ronald Reagan Parkway steering committee is taking a proactive approach to access management by incorporating these concepts from the beginning of project development. Unfortunately, that is not always the case. In fact, it is typical for access management to be considered only when problems occur on an existing roadway. By that time, the most effective strategies are difficult, if not impossible, to implement.

Since the Ronald Reagan Parkway is at such an early development stage, access management principles can be applied as the roadway and its features are being defined. This represents an enormous opportunity for developing an access management plan that will best suit the needs of the parkway without the constraints of an existing roadway.

Four fundamental elements of access management drive virtually all decisions regarding project design, including the access management components of the Ronald Reagan Parkway Master Plan. They are as follows:

- Functional Classification
- Roadway Location and Alignment
- Roadway Cross Section
- Access Locations and Control

The relationship of each of these key elements to the access management plan is reviewed in the following sections, followed by a section describing implementation strategies.

FUNCTIONAL CLASSIFICATION

Functional classification refers to a roadway’s primary purpose. With the exception of fully controlled access freeway facilities, all roadways serve some combination of through travel and access to property. Roadways that are primarily intended for traffic service (typically for longer trips) are referred to as arterials. Those intended primarily for access to abutting land use are local streets. Collector roadways link local streets with arterials and often serve balanced demands for travel and access to property.

In many ways, the functional classification system for a network of roadways is analogous to a tree, with the arterials serving as the trunk, the collectors serving as the branches, and local streets serving as the twigs that tie directly with the leaves (representing individual land parcels).

Identifying the functional classification of a roadway is an important step in development because it drives many decisions regarding the physical needs of the facility, including lane requirements, appropriate design standards, cross section elements, right of way, and access management components. Functional classification should be defined in the context of the overall roadway network to provide a balanced system that meets both travel and access requirements.

Based on area-wide planning studies of the involved communities and environmental impact studies for the roadway, it is assumed in this review that Ronald Reagan Parkway will serve as a primary arterial. The figure below, **FIGURE 7.2**, illustrates the ideal roadway function that the County will strive to achieve for the Ronald Reagan Parkway.

FIGURE 7.1: Roadway Alignment

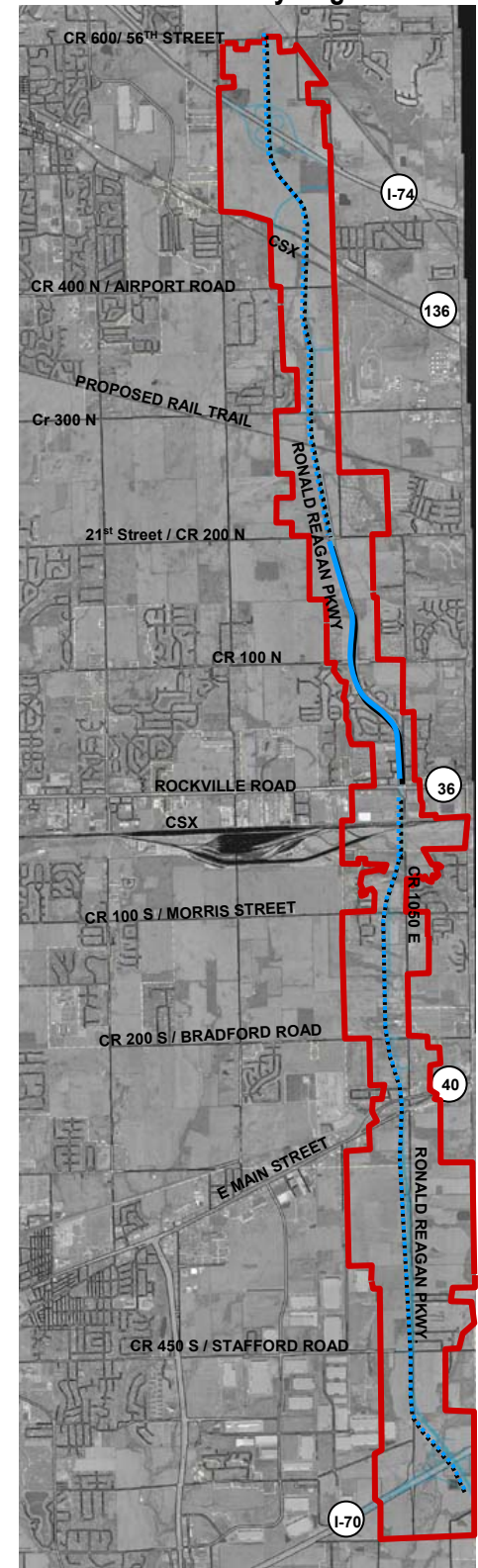

- STUDY AREA BOUNDARY
- RONALD REAGAN PARKWAY -BUILT
- RONALD REAGAN PARKWAY -PLANNED

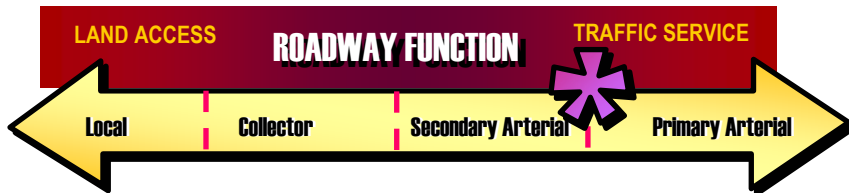

FIGURE 7.2: Functional Classification

LOCATION / ALIGNMENT

Once the functional classification of a roadway is identified, the next defining element is its location and alignment. The location and alignment of the Ronald Reagan Parkway is now firmly established after many years of study. An interchange justification report for the Six Points Road interchange and the southern leg of the Parkway was prepared in 1992. An environmental impact study was performed for the project in 1993. It was later amended and was ultimately approved by the Federal Highway Administration in 1996.

At this time, the location and alignment of the corridor are well established between I-70 and I-74. A portion of the roadway has been constructed north of US 36, and the Six Points Road interchange with I-70 is under construction. Commissioners of Hendricks County have initiated preliminary discussions with Boone County Commissioners to extend the roadway north to I-65, but an alignment for this potential extension has not been defined.

CROSS SECTION

The cross section establishes the right of way width necessary to accommodate the roadway and all of its associated features. These features include the number of travel and auxiliary lanes, pavement edge treatments/drainage, pedestrian features, utilities, landscape/buffers, and space for future expansion (as appropriate). All of these features must be considered in establishing the overall right of way for the roadway. Each the functional elements in the roadway cross-section are discussed in the following sections. The typical roadway cross section is illustrated in **FIGURE 7.3**.

Number of Lanes:

From the beginning, the parkway has been planned as a four-lane roadway. Traffic forecasts developed for environmental studies and more recent comprehensive planning studies conducted for Plainfield support the need for at least four travel lanes. Given the roadway's location within the larger roadway network, its planned interstate highway connections, and the level of development anticipated along the route, it is reasonable to plan for a divided roadway with a minimum of four lanes. Auxiliary lanes will be needed to accommodate turning movements, and providing for the addition of another through lane in each direction in the future would be desirable.

Median Width:

As a minimum, the median should provide sufficient width for auxiliary turn lanes at major entry points. Considering this, the median width should be a minimum of 16 feet at all locations. If right-of-way allows, a wider median would be desirable to accommodate double left turn lanes at selected locations and to provide for added travel lanes if warranted in the future. A wider median would also provide a safer and more attractive roadway, with an opportunity for landscaping treatments.

Edge Treatments/ Drainage:

There are two fundamental approaches for providing edge treatments along travel lanes and accommodating drainage along the roadway: curb & gutter/storm sewers and shoulders/roadside ditches. Each design offers advantages and disadvantages.

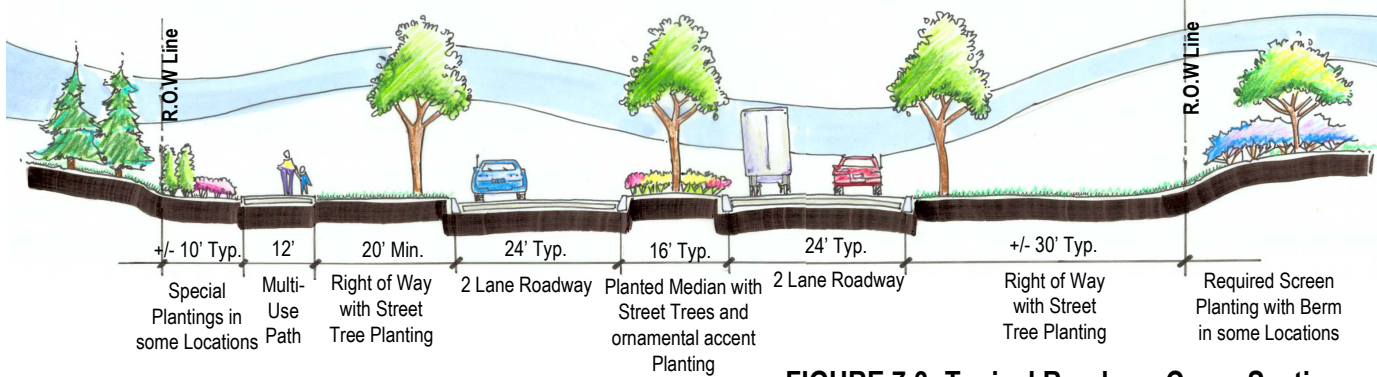

FIGURE 7.3: Typical Roadway Cross Section

Curb & gutter clearly defines the edge of the travel lanes, provides an urban “feel” for the roadway, and improves safety by providing a barrier for errant motorists. This safety benefit also provides additional opportunities for landscaping since clear zone requirements (typically one foot from face of curb) along the roadway are significantly reduced compared to the use of shoulders. Curb & gutter sections with storm sewers ordinarily cost more to construct than shoulders and ditches, but less right of way is required.

Shoulders provide a more open “rural” feel for the motorist and allow disabled vehicles to pull out of the traveled way. They are typically installed with roadside ditches to drain the roadway. For a four-lane divided roadway, shoulders should be paved areas at least 11 feet in width. Required ditch dimensions vary depending on flow requirements and the terrain. Since there is no barrier, clear zone standards typically require an open space of 30 feet or more from the traveled way, limiting opportunities for landscape treatments and other physical features near the roadway. Guard rails can remedy this, but since the guard rail itself constitutes a hazard, it should only be used where it is blocking a more severe hazard that cannot be removed.

The key variables for selecting edge treatments are cost, aesthetics, availability of right of way, and plans for future expansion. The trade-offs for the first three items are described in previous paragraphs. The potential for future expansion relates to the selected median width. Generally, a wide median provides space for future added travel lanes on the inside, with little or no disruption to curb & gutter, storm sewers and other features located on the outside. Shoulders with ditches provide an opportunity to add lanes on the outside, often with the installation of curb & gutter/storm sewers to maintain a similar overall cross section width.

Utilities:

Given the linear nature of roadway rights of way, it is typical for them to accommodate utilities in addition to transportation elements. The desirable space for utilities can vary according to local need, but typically, at least fifteen feet of right of way should be provided outside paved areas for this use.

Pedestrian Features:

During recent years, highway design engineers have become more sensitive to the needs of bicycles and pedestrians. All of the communities served by the Ronald Reagan Parkway have adopted plans for non-motorized travel and require sidewalks or bicycle/pedestrian paths wherever roadways are provided as part of planned developments. These facilities are much easier to accommodate as a part of initial design than they are to retrofit within existing rights of way.

As a minimum, a 12 foot paved pathway should be provided on at least one side of the roadway. The recommendations of this plan are encouraging the development of a multi-use path along the entire length of the corridor in order to create a strong pedestrian network. Ideally, facilities would be provided on both sides of the roadway. The development of a 12' multi-use path on both sides of the roadway is encouraged in high pedestrian areas. In areas where a 12' path is provided on at least one side of the roadway, a 6' sidewalk would be acceptable for the opposite side of the roadway in order to accommodate pedestrian movement. All bicycle/pedestrian facilities should be separated from the roadway edge, and should not be located within the roadway's clear zone.

Landscaping/ Buffers:

The aesthetic character of the roadway (and the community) can be significantly enhanced by landscape features where sufficient space is made available for these elements along a roadway. In some cases, landscaping serves to enhance the driving experience. In others, particularly in combination with sound walls or earthen berms, it can provide a visual or noise buffer for abutting properties. There is no “set” dimension for these features. They are a matter of site-specific design. For more information on landscape elements, refer to Section 6.

Roadway Expansion:

Experience has shown that it is prudent, particularly for a primary arterial such as the Ronald Reagan Parkway, to provide for future added travel lanes as a part of initial design. It would be desirable in this corridor to provide for a six-lane divided roadway, particularly near the proposed interchanges with I-70 and I-74 since these will serve as

major points of concentration for traffic throughout the corridor. As discussed previously, this might be accomplished in either the median or shoulder area. Either way, it should be planned for from the beginning so that minimal grading and drainage changes are necessary if expansion is required.

Roadway expansion may also be a consideration in staging initial construction. In many areas, a two-lane roadway may meet initial corridor needs. In this case, both four-lane and six-lane sections should be considered in developing staging strategies and grading plans for initial construction.

ACCESS CONTROL

The fourth major item to consider in initial development of Ronald Reagan Parkway is access control. It is just as important to effective operations as the location and cross section of the roadway. As with alignment and cross section, access control is a significant engineering factor in facility design. More importantly, however, access control is a regulatory issue requiring coordination among jurisdictions and continual vigilance to insure that overall roadway operations are not compromised.

There are a number of design factors to consider with respect to access control, including the following: traffic signal spacing, driveway layouts and design, driveway offsets and spacing, and shared access opportunities. The relationship of each of these design factors to access control is presented in the following sections.

Traffic Signal Spacing:

Unless a decision is made to provide full access control (i.e. interstate or freeway standards with grade separated interchanges), signalized intersections are likely to determine the level of service and quality of overall roadway operations. At an isolated intersection, the level of service of a roadway is determined directly by the traffic signal. Where intersections are spaced a mile apart or less, roadway capacity is determined by how well the traffic signals operate as a system. The figure to the right illustrates 1 mile and ½ mile spacing of existing crossroad along the corridor.

FIGURE 7.4: Traffic Signal Spacing

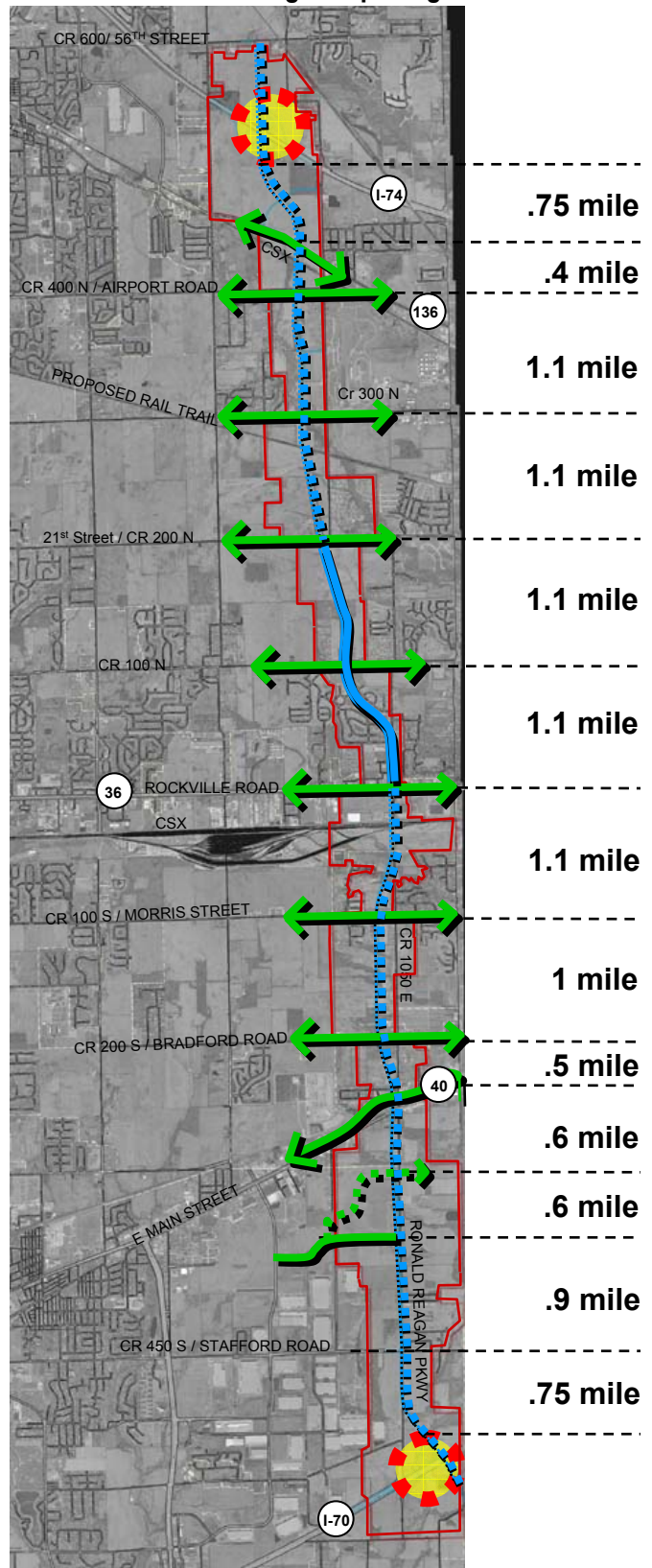

The coordination of adjacent traffic signals is straightforward in concept. The signals must operate on the same cycle length, with offsets timed to match the arrival of vehicles from the upstream intersection. Cycle length is the total time allocated to all signal indications. Offsets are the points in time during the cycle that each indication starts. Pre-timed traffic signals repeat a cycle of a set length with fixed offsets over and over, and the relationship between intersections is maintained through each cycle. More sophisticated systems may vary the cycle length, but for a given travel speed, the relationship between offsets of adjacent intersections is held constant to maintain progressive flow.

The coordination of traffic signals is easy on a one-way street. Timing patterns are developed to provide a “band” of green time based on a specific travel speed. Signal coordination becomes more complex for two-way operations since the optimal pattern in one direction may not work in the other direction. Generally, two-way progression can only be established where signalized intersections are evenly spaced. In fact, irregular spacing of intersections can make two-way progression mathematically impossible. For that reason, identifying major intersections or entry points to optimize traffic signal operations may be the most important access strategy of all in early planning for arterial roadways.

The spacing of signalized intersections along Ronald Reagan Parkway will be established by cross street locations and major driveways with median openings to serve left turns. With the exception of the existing section of the parkway just north of US 36, driveway locations are still to be determined, and the potential for coordinated traffic signal operations relates to the location of public road intersections.

FIGURE 7.4 indicates the spacing of existing roadways crossing the Ronald Reagan Parkway corridor. Fortunately, Hendricks County roadways were originally laid out in a grid pattern with approximately one-mile spacing between roadways. At some locations, roadways have been constructed at intermediate locations. Overall, the entire corridor is served by cross roads that are within a tenth of a mile of providing half-mile spacing, except at the “ends” near interchanges.

If the one-half mile pattern of intersections is maintained without further interruption of traffic flow by driveways and median cuts, it will be possible to provide coordinated signal operations over virtually the full length of Ronald Reagan Parkway. Maintaining this spacing of major intersections should be a priority for all jurisdictions as development proposals are presented. Generally, this will require that access is accommodated by way of existing cross roads or new cross roads or drives within the one-half mile grid. In some cases, these new drives may require shared use by adjacent developments.

If other access points are required, they should be provided without a median opening (right turn in-right turn out), even if this requires some motorists to make U-turn movements at intersections. Although some access points will not require signalization when constructed, it would be prudent to assume that any access point with a median cut might someday be signalized, and to treat each request for access accordingly.

Due to its importance for future operations, and recognizing the need for associated regulatory attention over time, traffic signal spacing and associated access control policies are the single most important element for maintaining high quality traffic flow characteristics on Ronald Reagan Parkway in the future.

Driveway Location and Design:

In order to maintain the integrity of overall operations of Ronald Reagan Parkway, signalized access points should be allowed only at locations that fit with optimal spacing of traffic signals for progression. If other access points are allowed, crossing of the median should not be allowed and they should not be signalized. In most cases, major developments should only be allowed to access the parkway at public roadway intersections that intersect at appropriate locations within the traffic signal system. **FIGURE 7.5** illustrates potential access points or median openings at ½ mile between existing crossroads as recommended in this plan.

Permitting Requirements/ Development Issues:

Driveway design standards should be adopted that provide appropriate tapers to accommodate the vehicles being served. Acceleration and deceleration lanes may be desirable at some locations, as indicated in traffic impact studies for specific developments. These requirements should be established by ordinance.

IMPLEMENTATION OF THE ACCESS MANAGEMENT PLAN

There are four strategies for the implementation of the access management recommendations. These include the adoption of a corridor overlay zone, intergovernmental agreements, model zoning/subdivision ordinances, and traffic impact analysis requirements for development.

The implementation of a corridor overlay zone typically does not require changes to the underlying zoning or overhaul of existing ordinances. This can be implemented by delineating areas on zoning maps. These regulations must then be adopted by local ordinance. These regulations should be implemented to apply to side street intersections as well as major roadway access points.

The access management plan is critical to roadway function. Once implemented, it will help to preserve the integrity of the roadway function with high efficiency. In addition, it will help to reinforces roadway as a consistent master planned corridor while increasing the safety of the roadway.

FIGURE 7.5: Potential Access Points

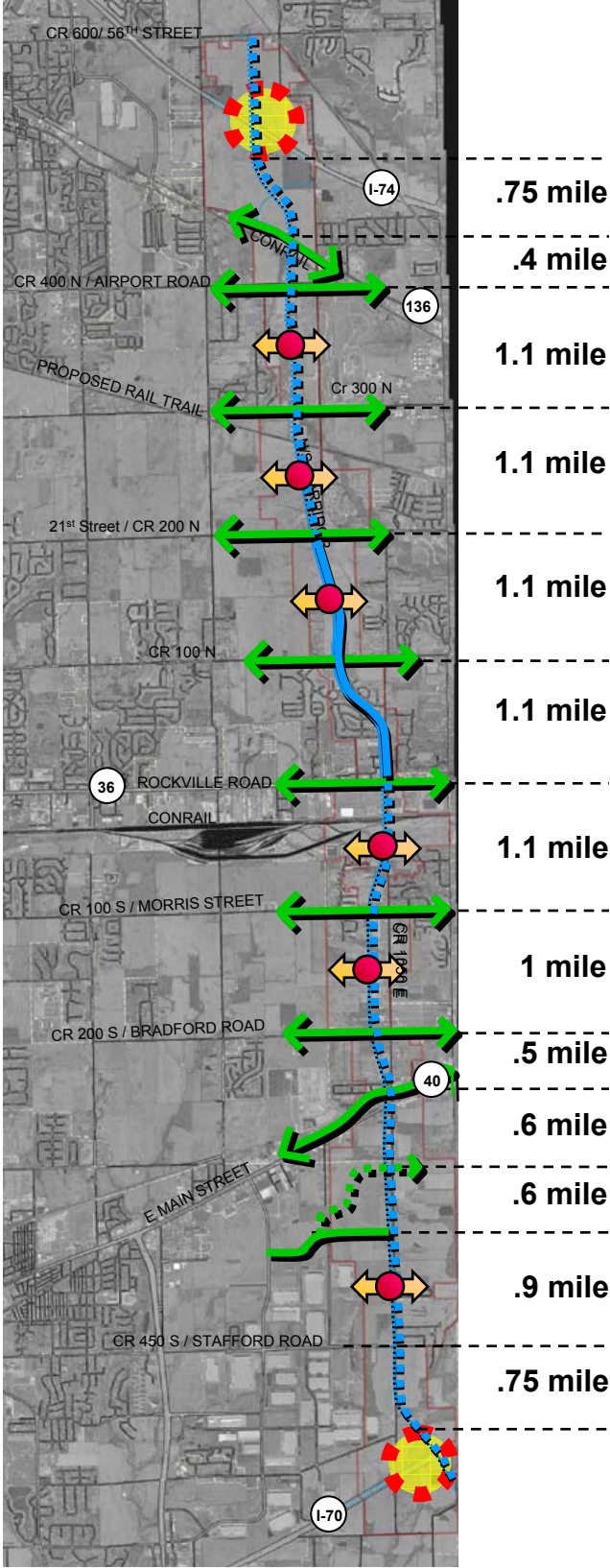

Fight

Section 8: Implementation

**Implementation Techniques and Financing Plan for the
Ronald Reagan Parkway**

GETTING IT DONE

Implementing a plan for the construction of the Ronald Reagan Corridor is a complex endeavor that requires a thorough understanding of potential implementation techniques/programs, financing tools, and the roles of all the communities and stakeholders. Funding sources and implementation techniques are important facets of the corridor's ultimate success. The proper perspective is necessary throughout the process, as the implementation of the Corridor Master Plan is a process that will continue to evolve and solidify as progress is made.

The previous chapters of the plan focused on “what” to do and “where” to do it, with an understanding of “why” it needs to be done. While these items are critical to the success of a well-planned corridor, they are not adequate to ensure that the plan is implemented. “How” and “who” are components that must also be considered in the implementation actions to follow. Implementation is the phase of the planning and design process which turns the vision, goals, and recommendations of the plan into reality.

While various components of the Corridor master plan contain goals, design recommendations, and guidelines, specific implementation strategies are necessary to ensure that the vision set forth in the plan is carried out. Planning efforts for creating new and well-planned economic development corridors do not just happen. The marketplace, without a roadmap, will often seek the path of least resistance. Endeavors that do not include specific steps and tools for accomplishing the goal and vision of the project often result in failed expectations and skepticism. This master plan document lays the groundwork for the design of the corridor and provides a clear vision for its future development. It is the ultimate goal of this project to see that the vision established throughout the planning process is achieved. The implementation techniques outlined in this chapter provide the roadmap for achieving that vision.

ONGOING COMMUNICATIONS

Due to the multiple jurisdictions this corridor traverses, inter-governmental cooperation is key to the success of this plan. Relationships and discussions between the local governments of Avon, Brownsburg, Plainfield, Hendricks County, and the Indianapolis Airport Authority should continue as they have cooperated in the visioning of this plan over the past nine months. These governing bodies should be partners in implementing the elements outlined in the plan. In this way, each body has a distinct role to play in implementing the plan while at the same time understanding the full scope of the program to keep the other parties advised of the level of progress being made.

IMPLEMENTATION TECHNIQUES

A combination of implementation techniques have been explored as potential opportunities for use in the development of the Ronald Reagan Parkway Master Plan.

The implementation techniques outlined in the following sections are intended to serve as a guide for the communities, their leadership, and potential developers and investors. The more techniques that are utilized, the greater the potential for success of the plan. These implementation techniques, if properly utilized, will ensure the success of the corridor's development as a premier economic development corridor in Hendricks County.

Adoption of the Corridor Master Plan by Resolution

The Ronald Reagan Corridor Master Plan represents the vision of the future development of a premier economic development corridor in Hendricks County. The focus of the plan includes three major components including a land use plan, roadway enhancement design, and access management recommendations. This master plan document is a result of citizen and governmental leadership input that is represented in the recommendations of the plan. The vision of the Corridor Master Plan cannot be implemented without its adoption by the governing bodies in conjunction with the zoning overlay district that was developed as part of the project.

In order to establish a firm endorsement of the Plan, it is important that the Ronald Reagan Corridor Master Plan be adopted by resolution as the land use and economic development vision of that portion of Avon, Brownsburg, Plainfield, and Hendricks County. In effect, this master plan is a focused sub-area plan of the communities' comprehensive plans, and should be used in that manner. The plan should be presented and adopted by the local Plan Commissions, Town Councils, and County Commissioners representing all jurisdictions involved. The approval of local governments will enact the plan as a policy guide for this sub-area of the community. Once adopted, the plan, although not binding, can be used as a decision-making tool. The plan should be utilized as a policy guide when making decisions that affect the corridor including activities such as re-zonings and capital improvement planning.

Adoption of the Overlay District by Ordinance

In addition to the adoption of the master plan, the local municipalities should review and modify for local circumstances and adopt by ordinance the model corridor overlay district ordinance to protect the objectives set forth in the plan. The model corridor overlay district is written as a means for implementing the vision set forth in the master Plan.

The purpose of an overlay zoning district is to supplement the requirements of underlying zoning districts located within the designated overlay boundaries. These districts include the Towns of Avon, Brownsburg, Plainfield, and Hendricks County. In order to be effective, each community must adopt the overlay as a component of their existing zoning ordinance. Once adopted, the overlay will serve as an instrument for implementing the objectives set forth in the plan.

In each jurisdiction's Zoning Ordinance, the future development of lands within the corridor overlay district will be subject to the standards of the base zoning district in which they occur, as well as the standards that are specific to the Corridor Overlay District. This allows fewer required changes for base zoning districts and allows uniform and

higher design criteria to be applied specifically to the corridor. The model overlay ordinance addresses issues such as architectural design, landscape and buffering, signage, lighting, and access management as they relate to the development of the corridor.

In order to strengthen local support, the Steering Committee should participate in the adoption of the Overlay District ordinance. Members of the Steering Committee should present the zoning ordinance amendments to the Plan Commission as champions of their plan. This local ownership is an effective way for the plan to be successful and utilized by all.

Adoption of any Additional Access Management Regulations by Ordinance

One of the key focuses of the Master Plan was the study of various access management recommendations. These recommendations were made in order to protect the integrity of the roadway in accommodating the movement of traffic in the most efficient manner.

As was pointed out in the access management analysis, these provisions were incorporated in a variety of implementation documents dependent on the community. In some, the provisions are contained in the local subdivision regulations, zoning ordinance, or other special ordinances. Given the range of locations where access management is implemented, it is recommended that the local governments review the recommendations for access management along the Ronald Reagan Corridor and that the community incorporate those standards into their most appropriate regulating document.

Adoption of a Multi-Jurisdictional Intergovernmental Agreement by Resolution

The adoption of an intergovernmental agreement would help to further ensure the success of the plan and would further reinforce the cooperative spirit developed between all local governing parties in developing this master plan. In a typical intergovernmental agreement, those parties entering into the

resolution agree to adopt the principles of the plan, to adhere to its overall vision. Avon, Brownsburg, Plainfield, Hendricks County, and the Indianapolis Airport Authority should establish a resolution that demonstrates a commitment to adhere to the principles set forth in the Corridor Master Plan. The intergovernmental agreement should require that each participating body also pass ordinances and resolutions to implement the plan. Ideally, the resolution would include an agreement to participate in an intergovernmental meeting on a regular basis to talk about progress and implementation of the plan. Furthermore, the resolution should require each jurisdiction to notify the others when they receive a development proposal in the corridor. All participating Plan Commissions should be provided the opportunity to provide feedback and recommendations on all development proposals affecting the corridor area. The use of an intergovernmental agreement will contribute to the progress of implementing the master plan, and further reinforces the commitment and cooperation of all local jurisdictions.

FINANCING ALTERNATIVES

At the conclusion of this plan, it was the consensus of the Steering Committee that all parties involved should work towards the completion of the project in an expedited manner. Ideally, the entire project would be constructed in a holistic way. This approach would allow the project to proceed as a single concerted effort, rather than as various interconnected segments over an extended period of time. The planning of the corridor as a single large-scale corridor project would have several advantages. First, a consistent design and treatment would be ensured. Second, construction would occur within a shorter time frame, rather than the build-out of several small segments over a long period of time. Finally, funding could be handled in a single project, and which may significantly reduce costs. The following potential financing techniques are listed in order of recommended priority.

Special Congressional Set Aside

The Ronald Reagan Corridor is a needed regional corridor passing through multiple jurisdictions and connecting at least two interstates (I-74, I-70) and probably a third (I-65). Given its regional interest, a strong case could be made for Congressional and Statewide funding. To date, the local

municipalities are currently exploring various funding options, and the possible distribution of TEA-21 funding may determine what approach is taken for the implementation of the corridor build-out. The County has requested \$18 million in TEA-21 funding to be utilized for the construction of the Ronald Reagan Parkway. If a large sum of TEA-21 funding is received, this would allow the project to proceed towards construction as a single major project. Various other funding methods have also been explored and are discussed in the sections that follow.

TIF Economic Development Area

Tax Increment Financing (TIF) is essentially a “self financing” tool for capital improvements in a designated area. When a TIF is adopted, the property tax revenues in that district are essentially frozen at that base year level for all taxing jurisdictions (county, municipal, schools, etc.). Over the life of the TIF, the incremental tax revenue increases that happen as a result of development (changes in assessed value) are captured and put in a special fund to pay for bond debt service or to fund improvements directly. When all costs have been paid, the tax allocation is discontinued, and increased property values result in higher tax benefits to all governmental units.

There are essentially two types of TIFs: Economic Development Areas and Urban Renewal (blighted) Areas. The Ronald Reagan Corridor would qualify as an economic development area because its purpose is to establish economic development in an area with potential for future growth.

There are typically two documents required for the establishment of a TIF district. The first document is a resolution defining the TIF area adopted by the Redevelopment Commission, Plan Commission, and governing bodies. A resolution is also required confirming the district by the Redevelopment Commission. The second document is a TIF feasibility study prepared by an experienced financial advisor, preferably an experienced CPA.

RONALD REAGAN

Corridor Master Plan

TIF funds can be spent on projects within the allocated area or on projects that directly serve or benefit the area. Typically, most project money is spent on infrastructure improvements including roads, sewers, etc. The amount of TIF funds generated typically increases as the area develops over the life of the TIF. The revenue generated by the TIF is impacted by a number of variables, including the assessed value both within and outside of the TIF boundaries. The assessed value, in turn influences the tax rate for the County. The replacement credit, if any, is also a factor in determining the TIF revenue. For a TIF, it is best to have planned major development or redevelopment to ensure that the assessed value increases substantially and a significant increment will be garnered to fund improvements within the area. As more construction occurs, it is expected that the revenue will, in turn, increase over the life span of the TIF.

The County may consider the use of a TIF district as a method for the construction of the Ronald Reagan Parkway. This financing method would allow for the County to expedite the build-out of the parkway in a manner that would otherwise be unlikely without large sums of outside funding.

County Bond in Conjunction with State/Federal Funding

Some communities utilize county bonds to construct roadway projects. Local examples of major roadway bonding include 146th Street in Hamilton County and Hazel Dell Parkway in Carmel. County bonds can be used in conjunction federal funding as a combination financing technique. If county bonding is preferred for the construction of the Ronald Reagan Parkway, it is recommended that the County appeal to INDOT and the MPO for priority funding. CAGIT and CEDIT can be utilized to back the bonds.

Certified Technology Park

Another funding technique that may be considered as a means for financing portions of the development of the Ronald Reagan Parkway is the establishment of a Certified Technology Park. The Certified Technology Park program is administered by the Indiana Department of Commerce.

For a development to meet the requirements of a Certified Technology Park, the area must contain at least one business engaged in high technology activity. With the establishment of Clarian West along the corridor, and the potential for medical-related office facilities and flex-tenant spaces, the County may explore the potential to draw technological facilities into the area. Likely locations for a technology park are in the central and southern portions of the corridor, either adjacent to Clarian West, or in the land use areas designated as Flex-tenant space. A further requirement for the establishment of a Certified Technology Park is that the area must have significant support from an institute of higher education. The County may explore a relationship with any statewide university.

Not only must the park function as a place for high technology activities, but the technology park must display potential as a business incubator. The Indiana Department of Commerce requires the submittal of a very focused business plan that meets specific criteria. It should demonstrate the potential to take advantage of unique specialties of public and private resources in the area. The establishment of a Certified Technology Park would reap the benefit of an allocation and distribution of taxes into the park. Portions of these funds could be utilized to finance infrastructure improvements along the parkway. The County and local municipalities may explore the use of a Certified Technology Park to fund specific targeted portions of the parkway. One approach may be to utilize the funding from the Certified Technology Park as a pilot project for the corridor. Although several restrictions must be met, this approach may be a feasible alternative for funding the first phases of the corridor, in the event that larger funding sources are delayed.

POTENTIAL STAGING OF CONSTRUCTION

A potential staging process should be explored in the event that the anticipated 18-million lump sum in TEA-21 funds is not granted. The utilization of a variety of techniques, rather than one single technique, would allow for the project to be staged in several sections. The local municipalities can compete for segment funds from TEA-21 to construct transportation enhancements along portions of the corridor.

TEA-21, the last major authorizing legislation for surface transportation, built on the initiatives established in the Intermodal Surface Transportation Efficiency Act of 1991 (ISTEA). These Acts combined the continuation and improvement of existing programs with new initiatives to meet the challenges of improving aesthetics and safety as traffic continues to increase at record levels. Broad objectives were adopted, such as protecting and enhancing communities and the natural environment, and advancing America's economic growth and competitiveness domestically and internationally through efficient and flexible transportation.

To be eligible for the Indiana Department of Transportation TEA (Transportation Enhancement Activity) funds, the project must fall under one of several transportation related categories. The categories most frequently applied includes the provision of facilities for pedestrians and bicycles, and the establishment of landscaping and other scenic beautification. Other activities may also be incorporated into the project as qualifying activities. The INDOT Enhancement funds are distributed in up to \$one-million dollar increments, and there must be a local match of 20% in order to qualify. Potential grant seekers are required to follow a process that includes written documentation supporting the intentions of the project, letters of support for the project and a cost estimate. Several projects statewide exemplify the benefits of TEA funding. These include the 29th and 30th Street Gateway Corridor around the Indianapolis Children's Museum and the Hulman Memorial Way leading to the Indianapolis Motor Speedway. The state is required to set aside 10% of certain transportation funding programs to provide annual allocations for TEA funding. From this amount, grants are typically given each year throughout the State of Indiana. Currently, a new Transportation Bill is before Congress for reauthorization. Assuming that the TEA program will be continued (and all indications are that it will be), this could be a viable funding source that should be sought for the construction of the corridor enhancements.

APPENDIX

Appendix 1

Model Inter-local Agreement Concerning an Area of Common Interest

MODEL INTER-GOVERNMENTAL AGREEMENT CONCERNING THE RONALD REAGAN CORRIDOR

Hendricks County, the Towns of Avon, Brownsburg, and Plainfield, and the Indianapolis Airport Authority

This agreement between Hendricks County, Indiana, herein referred to as “County,” and the Towns of Avon, Brownsburg, and Plainfield, Indiana, herein referred to as “Towns” and the Indianapolis Airport Authority, herein referred to as “Airport”.

WHEREAS, the County, Towns, and Airport have collaborated over the past year in developing a long-term vision for the critical north-south roadway between Interstate 70 and Interstate 74, known as the Ronald Reagan Corridor; and

WHEREAS, the collaborative vision of this corridor recommends that this area be a premier economic development corridor with high-quality development standards; and

WHEREAS, more stringent planning controls are recommended to ensure the preservation of the corridor’s accessibility and development quality; and

WHEREAS, the County, Towns, and Airport have an interest in the same geographic area referred to as the Ronald Reagan Corridor as illustrated in Exhibit 1; and

WHEREAS, portions of the Ronald Reagan Corridor are within the jurisdictions of the Hendricks County Plan Commission, the Avon Plan Commission, the Brownsburg Plan Commission, the Plainfield Plan Commission; and the Indianapolis Airport Authority;

WHEREAS, development along the Ronald Reagan Corridor impacts future development within the County;

WHEREAS, the County, Towns, and Airport want to make the development process as efficient as possible without compromising quality; and

WHEREAS, Indiana Code does not provide a mechanism that allows both the County and the Towns to review developments within an AREA OF COMMON INTEREST (ACI), herein referred to ACI, but does allow Counties and Towns to enter into inter-governmental agreements.

NOW THEREFORE, in consideration of the mutual agreements and covenants set forth herein, the County, Towns, and Airport agree as follows:

1. THAT, the AREA OF COMMON INTEREST (ACI) shall be defined as the Ronald Reagan Corridor as shown in Exhibit 1.
2. THAT, all parties agree to adopt the Ronald Reagan Corridor Master Plan as the long range vision for this area.
3. THAT, all parties agree to participate in an annual steering committee meeting to review the progress of the Ronald Reagan Corridor Master Plan. All parties agree to appoint at least one representative to the Ronald Reagan Parkway Steering Committee.
4. THAT, all parties will agree to utilize the model overlay ordinance contained in the Master Plan as a base document which they will then review and modify for local conditions and adopt as an amendment to their zoning ordinance.
5. THAT, the individual Plan Commissions, in order to maximize coordination, will route for comment any petition or development in the ACI that requires a hearing (rezoning, variance, special exception, conditional use, subdivision of land, development plan review, etc...) to the other Plan Commissions in the ACI and the Indianapolis Airport Authority as soon as possible.
6. THAT, the local governments will use the standards identified in the Master Plan for construction of the various improvements within the right-of-way of the Ronald Reagan Corridor. This includes the suggested standards for the road cross section, landscaping, trails/sidewalks, median treatment signage and other enhancements.

NOW THEREFORE, such Intergovernmental Agreement is approved by _____

On _____.

EXHIBIT 1: Area of Common Interest

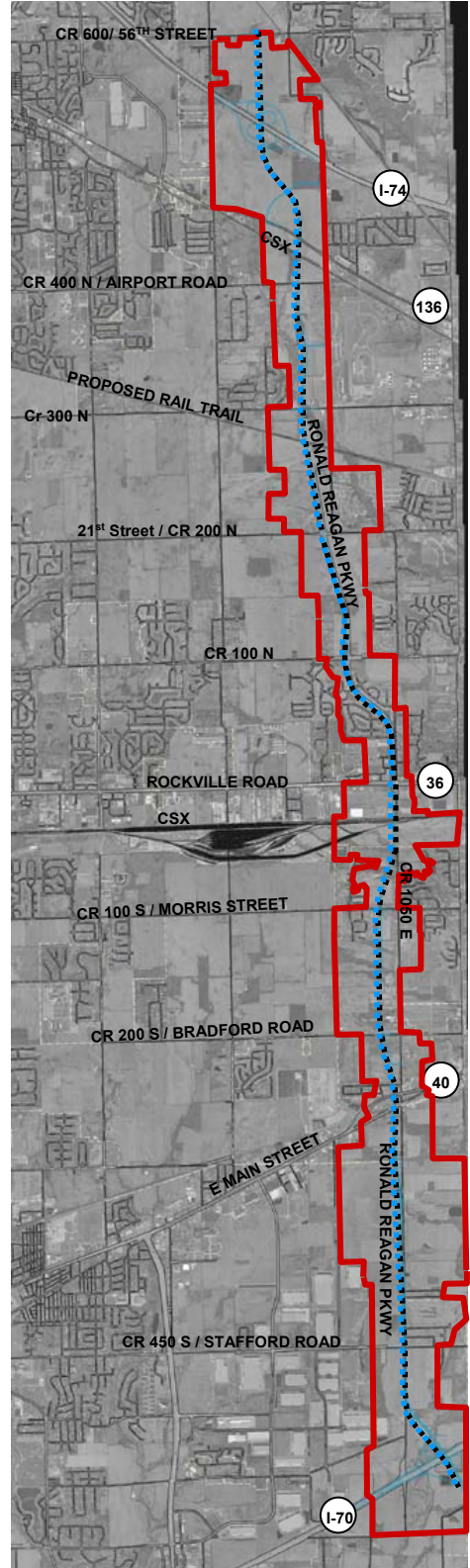

- RONALD REAGAN CORRIDOR STUDY AREA BOUNDARY
- - - RONALD REAGAN PARKWAY

APPENDIX

Appendix 2

Model Overlay Ordinance

USE OF THE MODEL OVERLAY ORDINANCE

The Model Overlay Ordinance contained on the following pages has been developed in coordination with the Ronald Reagan Corridor Steering Committee as a means for implementing the vision and design guidelines set forth in the plan. The model overlay ordinance addresses issues such as architectural design, landscape and buffering, signage, lighting, and access management as they relate to the development of the corridor.

Successful utilization of the Model Overlay Ordinance is critical to ensure the success of this plan. This model ordinance has been developed as an instrument that should be utilized to supplement the requirements of underlying zoning districts located within the overlay district boundaries. It has been developed with the intent that local municipalities should review and modify for local circumstances and adopt by ordinance the model corridor overlay district ordinance to protect the objectives set forth in the plan.

The overlay district boundaries established for this model ordinance are illustrated in the figure at right.

OVERLAY DISTRICT BOUNDARIES MAP

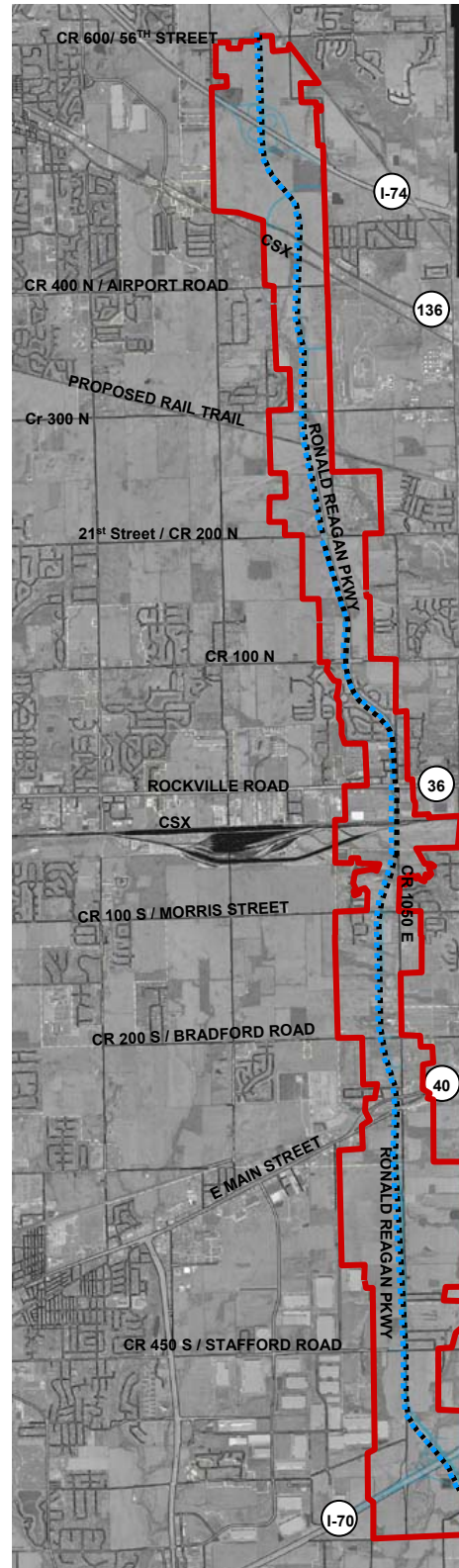

— RONALD REAGAN CORRIDOR OVERLAY DISTRICT BOUNDARY
- - - - - RONALD REAGAN PARKWAY

**Model Ordinance
Ronald Reagan Corridor Overlay District**

Purpose, Intent and Authority

It is the purpose of the Ronald Reagan Corridor Overlay District (herein referred to as the “Overlay District”) to promote and protect the public health, safety, comfort, convenience and general welfare by providing for the consistent and coordinated treatment of the properties bordering the Ronald Reagan Parkway in Hendricks County, Indiana.

The Plan Commissions, Town Councils, and County Commissioners, in establishing this district, are relying on IC-36-7-4-600 et. seq. and IC 36-7-4-1400 et. seq. This overlay district is, intended to serve as a tool for implementing the development policies and guidelines set forth in the Ronald Reagan Corridor Master Plan. The Ronald Reagan parkway is a limited access highway and an important economic development corridor to the Towns of Avon, Plainfield, and Brownsburg and Hendricks County. The Ronald Reagan corridor is a premier location and employment center whose viability, quality, and character are important to the community as a whole, adjacent residents, employees, business owners and taxing districts. Therefore, it is the further purpose of the Ronald Reagan Corridor Overlay District:

- To preserve the integrity of the road function through access management planning;
- To maximize the opportunity to create high level development through sound land use planning; and,
- To create a premier economic address in Hendricks County and the Towns of Avon, Plainfield, and Brownsburg through the development of aesthetic standards which make the corridor appear as a planned twelve-mile campus.

A. District Boundaries

The boundaries of the Overlay District are hereby established as shown on the attached map for Hendricks County, in the State of Indiana. The study area shall include the parkway alignment running north and south through Hendricks County, and adjacent properties within approximately 1000 feet on either side of the proposed parkway centerline as shown on Figure 1, District Boundary.

The Official Zone Maps for the Town of Avon, the Town of Plainfield, the Town of Brownsburg, and Hendricks County, in the State of Indiana are officially amended by the adoption of this Ordinance to include the Overlay District per the boundaries set forth.

If a portion of a parcel should fall within this identified boundary, the whole parcel shall be subject to the master plan and overlay district standards set forth for the corridor.

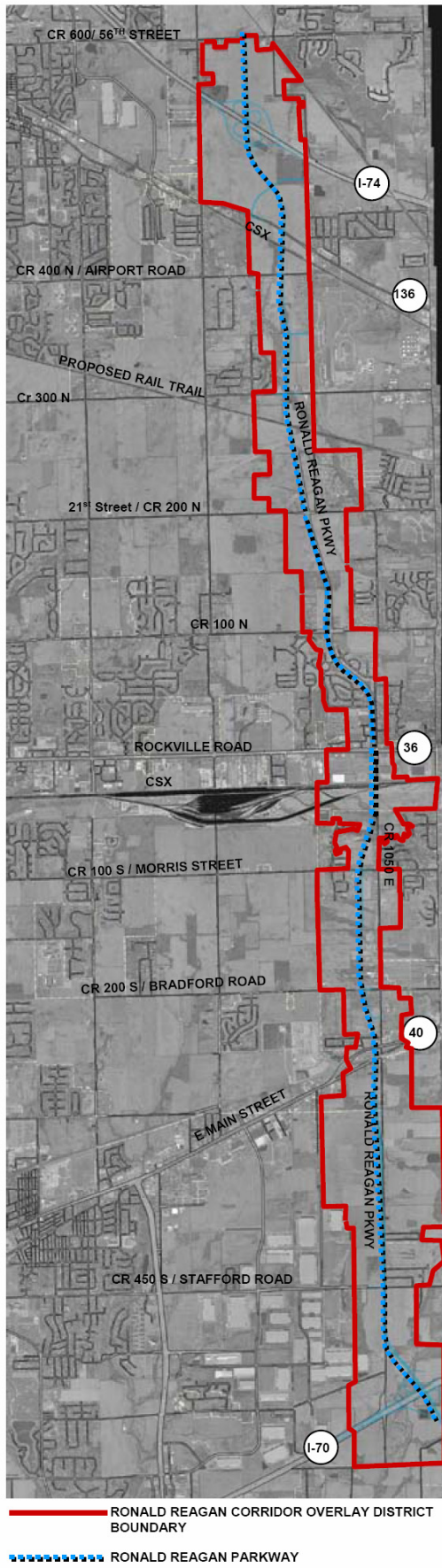

Figure 1: District Boundary

B. Plan Commission Approval

The appropriate Plan Commission body must approve, approve with conditions, or disapprove the development plan for any tract of land in the Overlay District per the provisions of this Ordinance. All development plans should adhere to the requirements set forth by the appropriate jurisdiction.

1) Application Procedure

See the appropriate local zoning ordinance for application requirements.

2) Findings for Approval by the Plan Commission

The appropriate Plan Commission may approve a Development Plan upon finding that:

- a. The Development Plan complies with all applicable Development Standards of the underlying district in which the site is located;
- b. The Development Plan complies with all applicable provisions of the appropriate Subdivision Control Ordinance;
- c. The Development Plan complies with all applicable provisions of the Overlay District;
- d. The proposed development is appropriate to the site and its surroundings; and
- e. The proposed development is consistent with the intent and purpose of this Ordinance and the Ronald Reagan Corridor Master Plan.

3) Validity of Approval of the Application by the Plan Commission

An approved development plan petition shall be valid for two (2) years from the date of approval. If construction of the building(s) has (have) not started at the end of the two (2) year period, the development plan request shall be re-submitted to the appropriate Plan Commission for consideration and disposition.

4) Removal of a District

Nothing in this Ordinance shall be deemed to deny the appropriate Plan Commission the power to remove an Overlay designation from one or more parcels in the proper case by the rezoning process described in the local zoning ordinance. Such removal may be done by rezoning the property to the underlying district classification “without the Ronald Reagan Corridor

Overlay District,” and may be subject to such conditions as may be voluntarily proffered and approved pursuant to local Ordinance.

C. Overlay Applicability

This district is created as a special overlay district to be superimposed on base districts by approval of the Town Councils and County Commissioners as appropriate. Boundaries of this overlay are shown on the zoning district map for each jurisdiction. Development standards provided herein are intended to supplement those permitted in the underlying zoning classification and in most cases may be more restrictive than those of the underlying zoning classification. When the requirements of the underlying zoning district or a local overlay district and the Overlay District appear to be in conflict, the more restrictive shall apply.

D. Definitions

Build-to line – An alignment established a certain distance from the right-of-way line to a line along which the building shall be built. Front porches and handicap ramps shall be exempt from build-to line requirements, and must occur behind the property line.

Façade – That portion of any exterior elevation on the building extending from grade to top of parapet, wall, or eaves and the entire width of the building elevation.

Flex Space – A building, usually prefabricated, that provides the appearance of a “store front” with a designated use and generally includes an additional use located within the back of a building. Typically these buildings are designed to be multi-functional containing office or retail space in the front of the building along the “store front” while other uses including office, retail, warehousing or light manufacturing are located in the rear of the building, hidden by the “store front” use.

Development Plan – Also referred to as Site Development Plan or Site Plan. A detailed plan, prepared in accordance with the rules and regulations of the appropriate jurisdiction, and submitted to the Plan Commission or other designated body or authority for review and approval. The plan shall illustrate the proposed development or alterations of a site.

Green Space Area – That portion of the front yard of a lot that is immediately adjacent and parallel to the street right-of-way of the Ronald Reagan Parkway and all other Roads within the identified boundaries.

Major Gateways - Regional gateways where major traffic thoroughfares intersect with the Ronald Reagan Parkway. For purposes of this project, these are located where the parkway meets the interchanges at I-70 and I-74.

Median Nose - The tip of a median at its terminus of traffic opening.

Overlay District – A district established by ordinance to prescribe special regulations to be applied to a site in combination with the underlying or base district.

Parapet – That portion of a wall which extends above the roof line.

Ronald Reagan Corridor – A 16 mile limited access highway and economic development area running north and south through Hendricks County, Indiana beginning at I-70, connecting the Towns of Avon, Plainfield, and Brownsburg to the Boone County Line. The corridor incorporates adjacent properties radiating out approximately 1000 feet on either side of the proposed parkway centerline.

Ronald Reagan Parkway – A 16 mile roadway alignment running north and south through Hendricks County, Indiana, beginning at I-70 connecting the Towns of Avon, Plainfield, and Brownsburg to the Boone County Line.

Secondary Gateways - Entries to public and private establishments and/or developments.

Sign, free standing – A sign anchored directly to the ground or supported by one or more posts, columns or other vertical structures or supports, and not attached to or dependent on support from any building.

Sign, monument – A free standing sign supported primarily by an internal structural framework and has its sign face or base on the ground with no air space, columns or supports visible between the ground and the bottom of the sign. Monument signs are also referred to as secondary gateways.

Sign, off-premise – A sign that directs attention to a business, commodity, service, or entertainment to a separate location not related to the premises where such sign is located or to which it is affixed.

Sign, unified centers - One sign which contains multiple smaller signs integrated into a free standing sign indicating the presence of multiple tenants on a property being constructed or managed as a single development. Such developments include, but are not limited to: shopping centers, strip malls, office parks and industrial parks.

Sign, wall – A sign mounted flat against and projecting less than fourteen (14) inches from, or painted on the wall of, a building or structure with the exposed face of the sign in a plane parallel to the face of the wall. This does not include window signs.

E. Permitted Uses

All uses which are permitted in a given site's underlying primary zoning district, except those uses expressly excluded in Section G of this Ordinance, are permitted in the Overlay District.

F. Permitted Special Exceptions

All special exceptions, which are permitted (upon obtaining the grant of a special exception from the appropriate Board of Zoning Appeals) in the underlying primary zoning district(s), except the uses expressly excluded in Section G, of this Ordinance, are permitted in the Overlay District.

G. Excluded Uses

The following uses are prohibited in the Overlay District.

1. Adult Business;
2. Amusement park/ go-cart track;
3. Automotive graveyard;
4. Bulk storage of petroleum products not used for on-site manufacturing;
5. Car rental agencies;
6. Cell towers and other wireless communication facilities;
7. Commercial Car and truck washes as a principal use;
8. Confined feeding operations;
9. Explosives manufacturing;
10. Fertilizer manufacturing, stock yards, slaughtering, leather curing and tanning;
11. Filling stations;
12. Garbage disposal plant/sanitary landfill;
13. Incineration for reduction of refuse;
14. Jail;
15. Junk or salvage yard;
16. Long-term surface parking;
17. Manufactured home dwelling sales;
18. Mineral extraction;
19. Mobile home park;
20. Ordinance products;
21. Outdoor sales;
22. Outdoor storage, with the exception of propane tanks. Propane tanks shall not be in the front yard between the roadway and the building unless otherwise screened with plant materials.
23. Penal or correctional institution;
24. Petroleum refining;
25. Reclaiming processes involving materials or chemicals that are considered dangerous to the health, safety, and welfare of the general public as determined by the State Board of Health or by the Hendricks County;

26. Refining or manufacturing of asphalt, cement, gypsum, lime, or wood preservatives;
27. Refining or manufacturing of petroleum products;
28. Roadside sales stand;
29. Sand and gravel extraction or sales;
30. Single-family residential uses;
31. Storage of disabled vehicles;
32. Vehicle sales; and
33. Waste transfer stations.

H. Accessory Buildings and Uses

All accessory buildings and uses which are permitted in the underlying zoning district(s) shall be permitted, except that any detached accessory building in any development plan shall be architecturally compatible with the primary building(s) with which it is associated.

I. Minimum Lot Area

The minimum lot area required within the Overlay District is 10,000 square feet for non-residential uses with sewer and 24,000 square feet for non-residential uses without sewer. All lots within the Overlay District shall be subject to development plan approval. For lots located only partially within the Overlay District, a development plan shall be submitted to the appropriate Plan Commission for the entire tract to be developed.

If a parcel of land or subdivision lot was recorded prior to the effective date of this Ordinance, and said parcel of lot does not contain the minimum lot area required by this paragraph, said parcel or lot (“Undersized Lot”) may be used for any use permitted in the Overlay District provided that:

- a. At the time of recordation of the undersized lot or on the effective date, the undersized lot met the requirements for minimum lot area then in effect for a lot in the underlying primary zoning district(s).
- b. The owner of the undersized lot must include, up to the minimum tract size, any adjoining vacant land (not separated by a street or public way) owned, or owned by an affiliate, on or before the effective date or at the time of application which, if combined with the undersized lot, would create a tract which conforms, or more closely conforms, to the minimum tract size requirements of this Paragraph; and,
- c. Other Development Requirements Applicable to the Overlay District

This Paragraph does not preclude the sale or other transfer of any parcel of land within a tract after the approval of a development plan for the entire tract. However, the development of the parcel must still conform to the development

plan for the entire tract as approved or amended by the appropriate Plan Commission, and all other applicable requirements contained in this Ordinance.

J. Development Requirements

1. Build-To Line

All lots located within the Overlay District that contain lot frontage adjacent to the Ronald Reagan parkway shall have their principal building located on the Build-To Line. The Build-To Line is a invisible line parallel to the Ronald Reagan Parkway that shall allow for a uniform setback and view of the corridor along the parkway. The Build-To Line shall be one hundred (100) feet from the edge of the Ronald Reagan Parkway Right-of-Way as illustrated in Figure 2, Build-To Line.

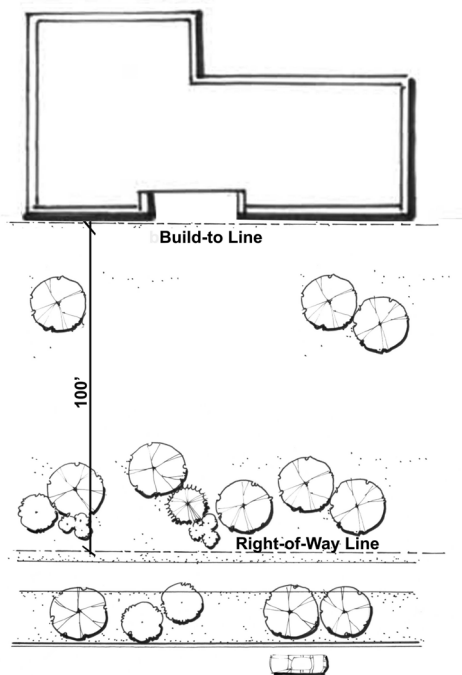

Figure 2: Build-To Line

2. Green Space Area

All lots within the Overlay District shall contain a Green Space Area. Refer to Section M, Subsection 2.a. of this ordinance for specific requirements.

3. Remodel, Expansion or Improvement of Existing Structure or Parcels

If a parcel fronts the Ronald Reagan Parkway and is improved or an existing structure is expanded or remodeled within the Overlay District, then that parcel or structure shall be subject to the regulations contained in this Ordinance.

K. Architectural Design Requirements – Commercial and Industrial

In reviewing the architectural design of commercial and industrial building(s) proposed to be built in the Overlay District, factors to be considered by the appropriate Plan Commission shall include but are not limited to the following:

1. Context

All buildings shall be designed with respect to the general character of the Ronald Reagan Corridor as defined in the Ronald Reagan Corridor Master Plan and, particularly, with due consideration to buildings located on the lots that abut the project site.

2. Massing

- a. A single, large, dominant structure mass shall be avoided in new buildings and, to the extent reasonably feasible, in development projects involving changes to the mass of existing buildings.
- b. Changes in mass shall be related to entrances, the integral structure and/or the organization of interior spaces and activities and not merely for cosmetic effect. False fronts or parapets create an insubstantial appearance and are prohibited.

3. Façade Treatment

- a. Facades along the Ronald Reagan Parkway frontage shall add architectural interest and variety and avoid the effect of a single, long or massive walls with no relation to human scale. No wall that faces a street or connecting walkway shall have a blank, uninterrupted length exceeding fifty feet without including, but not be limited to, at least two of the following:
 - 1) Change in plane,
 - 2) Change in texture or masonry pattern,
 - 3) Windows, trellis with vines, or
 - 4) An equivalent element.
- b. Facades greater than one hundred feet in length, measured horizontally, shall incorporate wall plane projections or recesses having a depth of at least three percent of the length of the façade and extending at least twenty percent of the length of the façade. No interrupted length of any façade shall exceed one hundred horizontal feet.
- c. Horizontal masses shall not exceed a height to width ratio of 1:3 without substantial variation in massing that includes a change in height and projecting or recessed elements.

- d. Building facades must include a repeating pattern that includes any one or more of the following elements.
 - 1) Color changes
 - 2) Texture change; and/or
 - 3) Material module change
- e. Facades shall have an expression of architectural or structural bays through a change in plane no less than twelve inches in width, such as an offset, reveal or projecting rib.
- f. Facades shall have at least one of the elements of subsections 3. a, b, c or d of this section that repeat horizontally. All elements shall repeat at intervals of no more than thirty feet, either horizontally or vertically.

4. Roofs

All facades shall have a recognizable “top” consisting of at least one element below:

- a. Parapets concealing flat roofs and rooftop equipment all or partially from public view. The average height of such parapets shall not exceed fifteen percent of the height of the supporting wall and such parapets shall not at any point exceed one-third of the height of the supporting wall. Such parapets shall feature three-dimensional cornice treatment;
- b. Overhanging eaves, extending no less than three feet past the supporting walls;
- c. Sloping roofs that do not exceed the average height of the supporting walls, with an average slope of greater than or equal to one foot of vertical rise for every three feet of horizontal run and less than or equal to one foot of vertical rise for every one foot of horizontal run; or
- d. Three or more roof slope planes.

5. Entryways

Use creative entry treatments and other focal points such as canopies, awnings, cornice treatments or atriums.

6. Building Elements & Accessory Structures

- a. Separate building elements or accessory structures should be designated as an integral part of the building design.

- b. Use signs that are complementary to and integrated with building design so that they do not dominate facades or appear tacked on.
 - c. Screen appurtenances or design them as integral parts of the buildings so that they are not visible from the street.
 - d. Screen docks, garage doors and service areas to minimize their visibility from adjacent streets.
7. Site Design and Relationship to Surrounding Community
- a. Building sites shall contribute to the establishment or enhancement of community and public spaces by providing at least two of the following:
 - 1) Patio/seating area;
 - 2) Pedestrian plaza with benches;
 - 3) Water feature, except in the area south of US 40 where water features are discouraged because they may attract wildlife to airport-related areas;
 - 4) Clock tower;
 - 5) Or other such deliberately shaped area and/or a focal feature of amenity that, in the judgment of the appropriate decision-maker, adequately enhances such community and public spaces.
 - b. Any such areas shall have direct access to the public sidewalk network and such features shall not be constructed of materials that are inferior to the principal materials of the structure and landscaping.

8. Landscape Design

Design of proposed landscaping in relation to structures. Landscaping shall be in conformance with Section M, Landscaping, of this Overlay District.

L. Open Space Requirements

1. Open Space Requirements

All sites shall provide for 15 percent open space on the lot. The required green space area can be counted towards the open space requirements.

2. Use of Open Space

In its review of the development plan, the appropriate Plan Commission shall consider how the location of open space within the development meets the following criteria:

- a. The protection of unique topographical features such as slopes, streams, and other natural water bodies;
- b. The protection of wooded areas, individual trees of significant size, wetlands or other environmentally sensitive features;
- c. A more efficient use of land, including the reduction of land area disturbed for utility lines and motor vehicular access;
- d. The minimization of the alteration of natural site features through the design and situation of individual lots, streets and buildings;
- e. Diversity and originality in lot layout;
- f. The relationship of the development to the surrounding properties; and
- g. Implementation of the greenways, pathways and trail recommendations of the Ronald Reagan Corridor Master Plan, and the appropriate jurisdictions Parks and Recreation Plan and/or Comprehensive Plan.

3. Standards for Open Space

- a. All open space shall be accessible by way of road, bikeway, sidewalk or foot path. Such access shall not be through private property or by way of an easement over private property.
- b. Areas dedicated as open space shall be a minimum of thirty (30) feet wide in their smallest dimension.
- c. Areas dedicated as open space shall be free of all structures and buildings except for structures directly related to the purpose of the open space such as patio/seating areas, gazebos, pedestrian plaza's, decks and bridges.
- d. Bodies of water may have fifty percent (50%) of their total acreage counted as open space.

4. Ownership and Maintenance of Open Space

Unless otherwise agreed to by the Plan Commission, the cost and responsibility of land dedicated as open space shall be borne by the property owner.

5. Open Space Plan

An open space plan shall be submitted along with the development plan in accordance with the appropriate jurisdictions rules and procedures.

M. Landscaping Requirements

In reviewing the landscape requirements proposed to be constructed in the Overlay District, factors to be considered by the appropriate Plan Commission shall include but are not limited to the following:

1. Landscape Plan

The applicant shall submit a landscape plan to the appropriate Plan Commission as part of the development plan application, per this Ordinance. Appendix 3: Recommended Plant Species of the Ronald Reagan Corridor Master Plan, lists the plant material recommended for use in the landscaping of a property in the overlay district.

2. Areas to be Landscaped

a. Green Space Area

A thirty (30) foot green space required for all property fronting the parkway within the Overlay District shall be composed of plantings as per the requirements in the Ronald Reagan Design Guidelines Manual and Section M.5 of this Ordinance. The incorporation of walkways and bikeways into the design is encouraged; however, no parking areas, through roads, buildings, accessory structures, etc. shall be established within this area.

b. Foundation

Foundation plantings shall be included along the front and any side of buildings that is visible from the Ronald Reagan Parkway or has primary pedestrian access.

c. Parking Lots

Parking lots shall be designed per the parking lot standards specified in the local zoning ordinance for the underlying district.

d. Screening Areas

All air conditioning units, HVAC systems, exhaust pipes or stacks, overhead doors, legally non-conforming outside storage areas, and satellite dishes shall be integrated into the overall building design or screened from the Ronald Reagan Parkway and adjoining land uses, by means of walls, fencing, parapets, penthouse screens, landscaping, berms, camouflage or other approved method.

e. Medians

Medians shall be landscaped per the standards specified in Section M.8 of this Ordinance.

3. Landscaping Standards

a. Plant Standards

All plant material proposed to be used in accordance with any landscape plan shall meet the following specifications:

- 1) Shade trees: A minimum of two and one-half (2 ½) inch caliper.
- 2) Ornamental trees: A minimum of one and one-half (1 ½) inch caliper.
- 3) Evergreen trees: A minimum height of eight (8) feet.
- 4) Deciduous shrubs: A minimum height of eighteen (18) inches.
- 5) Evergreen shrubs: A minimum height of eighteen (18) inches.

b. Design Standards

- 1) Wherever possible native species shall be used in the landscaping throughout the Ronald Reagan Corridor.
- 2) The placement of shade trees in pedestrian areas shall be sited to provide the optimum amount of shade to pedestrians.
- 3) Landscaping shall conform to the local sight triangle standards set forth in the zoning ordinances for Hendricks County, and the Towns of Avon, Plainfield, or Brownsburg as appropriate.

4. Protection of Existing Trees

- a. To the greatest extent possible, existing trees shall be saved upon development of a property unless it can be demonstrated that the site design restrictions necessitate their removal.
- b. The determination of which trees shall be saved shall be guided by the following principles:
 - 1) The practicability of arranging site plan components around existing features. In general, plans for groups of structures should be designed so as to preserve tree masses, individual tree specimens, and small stands of trees. Natural woodland areas shall be protected wherever feasible.
 - 2) The condition of the vegetation with respect to continued vitality.
 - 3) The practical and economic possibility of designing the location and grades of proposed structures and paving to preserve existing vegetation.
 - 4) The desirability or lack thereof a particular tree or species by reason of its appearance, historic or ecological significance, botanical characteristics, and the function the vegetation would fulfill as a site plan component.
 - 5) The potential for interference with utility services or with passage or visibility along roads or walkways.
 - 6) The possibility of preserving the vegetation while meeting the development needs through pruning rather than removal.
- c. Development Plans for sites with existing trees or stands of trees in the Overlay District should make reasonable efforts to protect and incorporate them into the overall site design.
- d. Prior to the approval of the development and the issuance of an Improvement Location Permit, the developer shall inventory trees on the site which have a caliper of eight (8) inches or greater, following the "American Standard for Nursery Stock" standards that are intended to be saved. The inventory shall contain the location, size, and common name of an existing stand-alone tree, areas of dense trees or shrubs, and other natural features. Existing trees saved in the development of the site shall be credited toward the landscaping requirements as identified in sub-subsection e below.
- e. To encourage tree preservation, each tree preserved greater than eight (8) inch caliper shall convert as credits for required landscaping. Credits for each preserved eight (8) inch caliper tree shall be:

- 1) Two (2) required shade trees or
 - 2) Four (4) ornamental trees
- f. Barriers will be used to protect trees during the development of the site. Substantial barriers shall be specified on the landscape plan and shall be placed at or beyond the dripline of trees to be protected. These barriers shall remain in place during heavy construction on the site and no vehicles, machinery, tools, chemicals, construction materials, or temporary soil deposits may be permitted within the barriers, nor may any notice or other object be nailed or stapled to protected trees.

5. Green Space Area

The following standards in this Section shall apply to all lots located within the Overlay District and have frontage on the Ronald Reagan corridor. The primary landscaping materials used in the thirty (30) foot green space area, shall be shade trees, ornamental trees, shrubs, ground covers and grass. See Figure 3, Green Space Area Requirements.

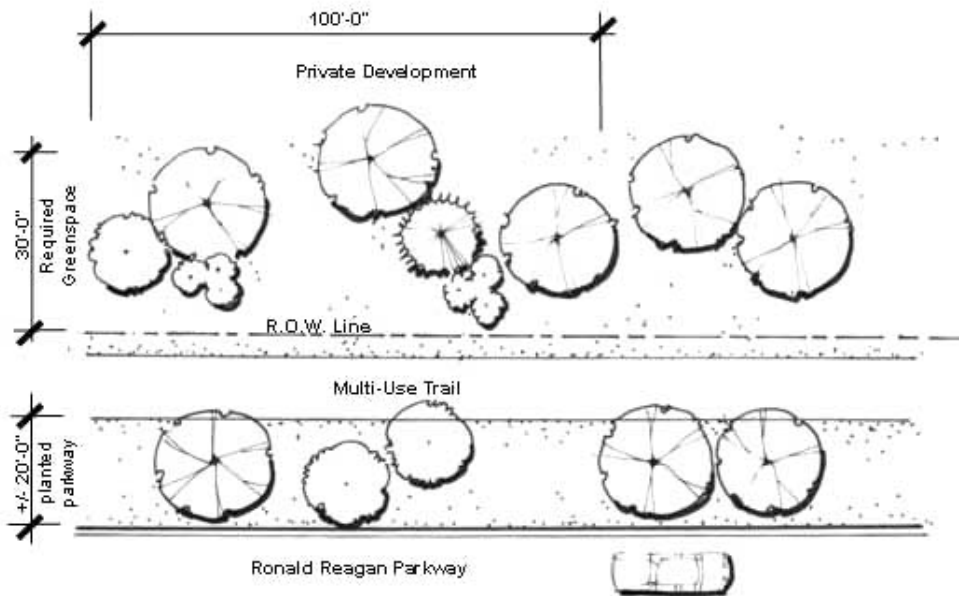

Figure 3: Green Space Area Requirements

- a. A minimum of three (3) shade trees, two (2) ornamental or evergreen trees, and six (6) shrubs shall be provided per one hundred (100) linear feet of green space area.
- b. Trees planted within the green space area parallel to the Ronald Reagan Parkway shall contribute to the overall natural character of the corridor. Trees

made be placed linearly or clustered in groups, with priority on natural patterns and clusters.

- c. Earthen mounds are required to screen parking lots fronting the Ronald Reagan Parkway. The earthen mound shall be covered with groundcover and shall have a minimum of three (3) shade trees, two (2) ornamental or evergreen trees, and six (6) shrubs per one hundred (100) linear feet and shall be parallel the Ronald Reagan Parkway as illustrated in Figure 4, Earthen Mound Requirements. The earthen mound shall be a maximum of five feet above surrounding grade and have rounded flanks. The mounds and landscape patterns shall maintain the natural appearance and character of the corridor.

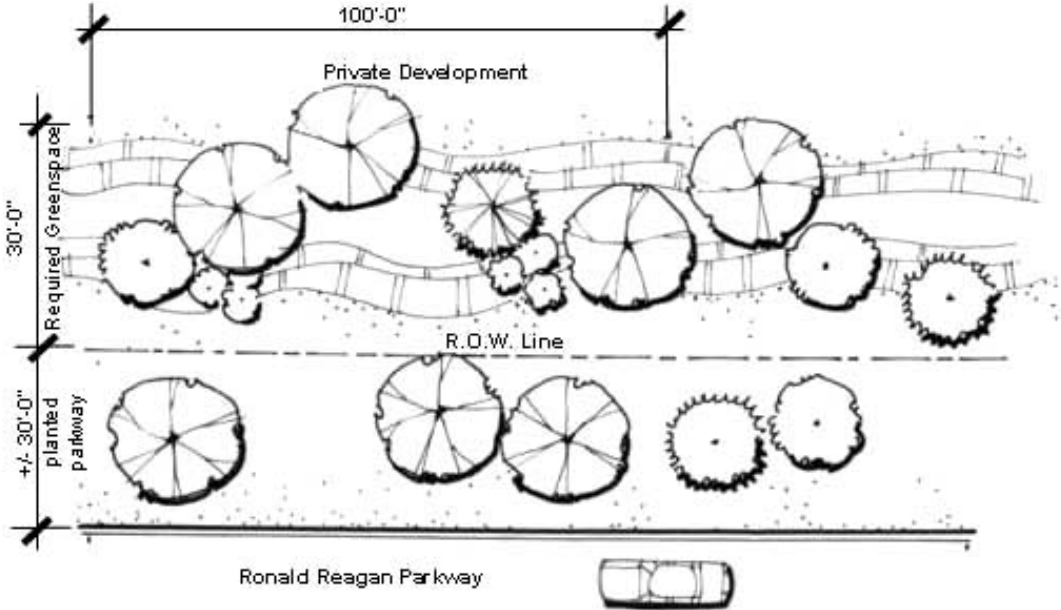

Figure 4: Green Space Area Requirements



Figure 5: Example of Earthen Mound

6. Foundation Plantings

- a. The primary landscaping materials used adjacent to buildings shall be shrubs, ground covers and ornamental grasses. Ornamental trees and perennials are also encouraged as accent plantings.
- b. The minimum width of the foundation planting area shall be five (5) feet, except that when adjoining a parking area located in the front yard adjoining the Ronald Reagan Parkway, the minimum width shall be ten (10) feet.
- c. In this foundation planting area, there shall be a minimum of twenty-five (25) shrubs per 100 lineal feet of planting strip. Shrubs can be placed linearly or clustered.

7. Parking Lots

a. Parking Lot Interior Planting

Where commercial, office, and industrial parking lots are located within the Overlay District, are located in the front or side yards of the building, and are visible from the Ronald Reagan Parkway:

- 1) A minimum of one (1) shade tree and two (2) shrubs shall be planted within each parking lot for every seven (7) spaces provided, or ten (10) trees per acre of parking, whichever is greater as illustrated in Figure 6, Interior Parking Lot Planting.



Figure 6: Interior Parking Lot Planting

b. Parking Lot Perimeter Planting

- 1) A six (6) foot wide perimeter planting area shall be provided along the front and sides of the entire parking lot as shown in Figure 7, Example Perimeter Planting Area.

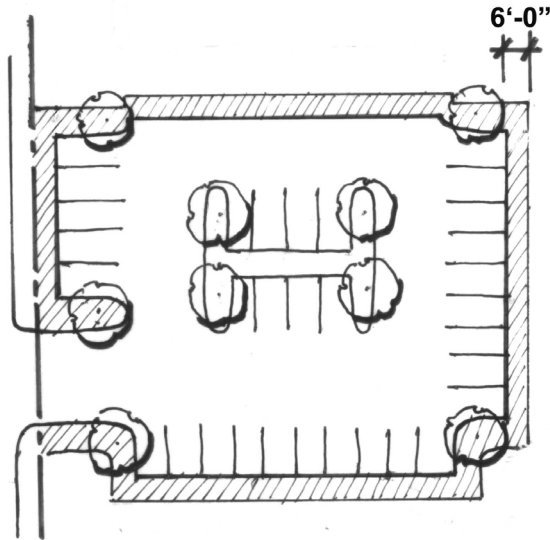

Figure 7: Example Perimeter Planting Area

- 2) If an earthen mound is used to screen the parking from the Ronald Reagan Parkway, additional perimeter planting shall not be required on the side that contains the earthen mound. However, the three (3) remaining sides shall be landscaped in accordance with the provisions set forth in this subsection.
- 3) The perimeter planting area shall be provided in addition to the green space area.
- 4) The required planting unit for this area shall include three (3) shade trees, two (2) ornamental or evergreen trees, and six (6) shrubs per one hundred (100) linear feet.

8. Median Landscaping Guidelines

These standards apply to all medians not located within the Ronald Reagan Parkway. All medians shall be a minimum of five (5) feet.

a. Plantings

- 1) Groundcover shall be incorporated into all median plantings. All medians shall be landscaped with a mixture of trees, shrubs, perennials, groundcovers, and annuals.
- 2) As a minimum there shall be one (1) tree and one (1) shrub per forty (40) linear feet.
- 3) The median plantings shall maintain the natural appearance and character of the corridor.

b. Sight Triangle

Sight triangle for visibility around median plantings shall be maintained in accordance with the local zoning ordinance requirements.

c. Paving materials

Paving accents such as brick or decorative pavers shall be incorporated into the median noses in a consistent manner with the Ronald Reagan Corridor Design Guidelines and Master Plan.

9. Landscaping Installation and Maintenance

a. Installation

All landscaping approved as part of the landscape plan portion of a development plan approval shall be installed prior to the issuance of a Certificate of Occupancy. If it is not possible to install the required landscaping because of weather conditions, the property owner shall post a bond prior to the issuance of the Certificate of Occupancy for an amount equal to 125 percent of the total installed cost of the required landscaping.

b. Maintenance

It shall be the responsibility of the owners and their agents to insure proper maintenance of all trees, shrubs and other landscaping approved as part of the landscape plan portion of development plan approval in accordance with the standards set by this Ordinance. This is to include, but is not limited to, replacing dead plantings with identical varieties or a suitable substitute approved by the appropriate jurisdiction enforcement official, irrigation and mulching of planting areas, and keeping the area free of refuse, debris, and weeds.

All dead plant material shall be replaced within one year or by the next planting season of their death or upon written notice of condition, except that during adverse weather conditions a longer period.

c. Changes after Approval

No landscaping which has been approved by the appropriate Plan Commission may later be materially altered, eliminated or sacrificed, without first obtaining further Plan Commission approval. However, minor alterations in landscaping may be approved by the appropriate jurisdiction enforcement official in order to conform to specific site conditions.

d. Inspection

The appropriate jurisdiction enforcement official or his/her designee may visit any tract within the Overlay District to inspect the landscaping and check it against the approved plan on file.

N. Parking Requirements

In reviewing the parking requirements proposed to be constructed in the Overlay District, factors to be considered by the appropriate Plan Commission shall include but are not limited to the following:

1. Parking Spaces required, and the dimensions of those Parking Spaces: See the appropriate standards from the local zoning ordinance.
2. Landscaping Standards: See Section M, 7 above for standards.
3. Parking requirements and design:
 - a. The required number of parking spaces is established in the local zoning ordinance for the underlying district.
 - b. There shall be an appropriate number of parking spaces reserved for use by handicapped individuals, per State and Federal requirements.
 - c. Direct, articulated pedestrian access shall be provided from the side street and parking area to the building's primary entrance.
 - d. Above grade, structured parking facilities shall have on all sides architectural features that are compatible with the principal building(s) with which they are associated.
4. Parking Lots shall be designed to provide coordinated access to parking areas on adjoining tracts or parcels within the Overlay District. As part of the development plan submission, the petitioner shall provide a site circulation plan that illustrates to the appropriate Plan Commission how coordinated access will occur relative to the overall Ronald Reagan corridor.
5. All parking areas and drives (including existing residential driveways) shall be paved with asphalt or concrete. Brick pavers or other decorative pavements may be used as accents in parking area design. Cast-in-place concrete curbs shall be used.

O. Signs

In reviewing the sign requirements proposed to be constructed in the Overlay District, factors to be considered by the appropriate Plan Commission shall include but are not limited to the following:

1. Signage Plan

The applicant shall submit a signage plan to the appropriate Plan Commission as part of the development plan application, per this Ordinance.

2. General Requirements

- a. In the Overlay District, signage shall be designed as an integral part of the architectural and landscaping plans. The colors, materials, and style of signage shall be architecturally compatible and accentuate the buildings and landscaping on the site. The colors, materials, and lighting of every sign shall be restrained and harmonious with the building and site to which it principally relates.
- b. Off premise signs shall be prohibited in the Ronald Reagan Overlay District Corridor, unless as otherwise specified in Section O, 3.
- c. All lettering or logos shall be prohibited on any awning in the Overlay District.
- d. Private traffic direction signs and pavement markings for the direction and control of traffic into, out of, and within the site shall conform to the Manual of Uniform Traffic Control Devices as published by the Indiana Department of Highways.
- e. The integration of development signage, particularly the sharing of signs to identify multiple businesses, is encouraged within the Overlay District. The appropriate Plan Commission shall have the authority to approve off-premise signage should it determine that such signage would promote the intent and purposes of the Ronald Reagan Corridor Overlay District. Any signage shall conform with the character of the corridor as outlined in the Ronald Reagan Corridor Master Plan.
- f. Every sign shall conform to the design regulations as specified in the Ronald Reagan Design Guidelines Manual.

- g. The number of graphic elements on a sign shall be held to the minimum needed to convey the sign's major message and shall be composed in proportion to the area of the sign face.
- h. Identification signs of a prototype design and corporation logos shall conform to the criteria for all other signs.

3. Off-Premise Sign Regulations

Off-premise signs shall only identify a building, business, profession or industry within the overlay district boundaries not fronting on the Ronald Reagan Parkway. Off-premise signs shall only be permitted by right for unified centers such as business parks, office parks, industrial parks and shopping centers under the provisions contained herein in the Overlay District. Only one such sign shall be displayed for each unified center.

Off-premise signs shall meet the following requirements:

- a. Such signs shall not exceed thirty-two (32) square feet in sign area for a sign mounted flat on a building, thirty-two (32) square feet for a monument sign, and thirty-two (32) square feet for a free-standing sign.
- b. Landscaping for unified center signs shall be in accordance with the standards in sub-subsection d, Sign Landscaping, below.
- c. Unified center signs shall resemble the character as depicted in Figure 8, Unified Center Sign.



Figure 8: Unified Center Sign

d. Sign Landscaping

- 1) The landscaping plan for any signs shall be created, as follows:
 - a) A defined landscaped area shall be placed at the base of the sign in a method harmonious with the landscape concept for the whole site. Landscaping should be an attractive and dense cluster equally attractive in the winter and summer. The required landscaped area shall be parallel to the face of the sign.
 - b) Formal plantings shall be required at the base of all secondary gateway (monument) and unified center signs. These shall be a minimum three feet (3') wide planting bed along both sides of signs containing a mixture of ground cover, shrubs, perennials, and annuals arranged as illustrated in Figure 9, Sign

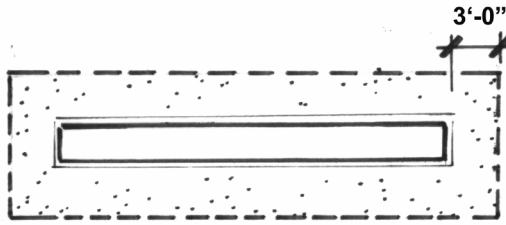

Figure 9: Sign Landscaping

- c) A landscaped area shall contain shrubs or perennials. The area shall be maintained to keep it free of weeds, debris, and brush.
 - d) Detailed drawings of the sign and landscaped area shall be submitted with the sign permit application for review.
 - e) Secondary gateway signs shall contain the Longshadow prairie planter and shall be landscape in accordance with the standards specified in the Ronald Reagan Design Guidelines Manual.
4. Wayfinding Signage
- a. Wayfinding signage shall be used to direct vehicular traffic to destinations in and near the Ronald Reagan Corridor. Parkway wayfinding signage shall be located within the right-of-way and shall meet the following criteria:
 - 1) Signs shall be free standing and located near intersections where they provide direction to local destinations for vehicular travelers. The signs shall not interfere with pedestrian accessibility.

- 2) Signs shall conform to the theme of the Ronald Reagan Corridor Master Plan. See Figure 10, Example Wayfinding Signage, as an example of approved signage. Signs shall be in accordance with the standards specified in the Ronald Reagan Design Guidelines Manual.



Figure 10: Example Wayfinding Signage

5. Gateway Signage

a. Locations

- 1) Major gateways shall be identified as the I-70 interchange, the Rockville Road/US 36 intersection, and the I-74 interchange.
- 2) Secondary Gateways shall mark entrances to public and private establishments.

b. Major Gateways

- 1) Major gateway signage shall be sited at Major gateways along the Ronald Reagan Parkway.
- 2) The major gateway signage shall incorporate the Ronald Reagan Parkway into its design.
- 3) Major gateway signage shall be constructed of natural materials consistent with the character of the Corridor as specified Ronald Reagan Corridor Master Plan and in accordance with the standards set forth in the Ronald Reagan Corridor Design Guidelines Manual illustrated in Figure 11, Example of Major Gateway.

- 4) Major gateways shall be of a scale appropriate for vehicular traffic as set forth in the Ronald Reagan Corridor Design Guidelines Manual.
- 5) Major gateways shall incorporate ornamental plantings, flags, and sculptural elements in accordance with the standards set forth in the Ronald Reagan Corridor Design Guidelines Manual.
- 6) Major gateways shall maintain appropriate line-of-sight as determined by local ordinance.

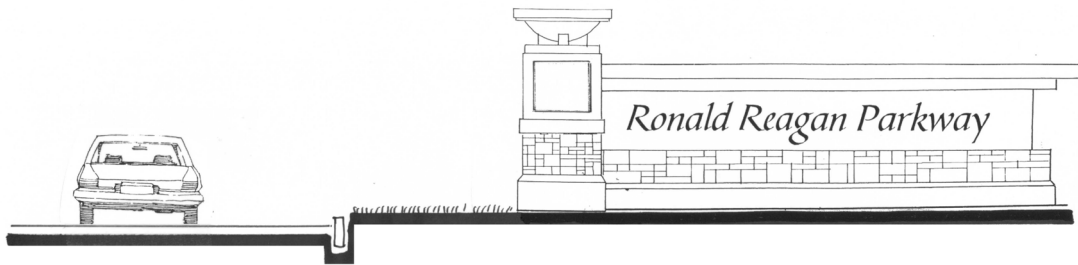

Figure 11: Example Major Gateway

c. Secondary Gateways

- 1) Secondary gateway signage shall be constructed of natural materials consistent with the character of the Corridor in accordance with the Ronald Reagan Corridor Design Guidelines Manual as shown in Figure 12, Example of Secondary Gateway.
- 2) Special accent plantings shall be used to highlight the gateway as a distinct area in accordance with the Ronald Reagan Corridor Design Guidelines Manual.
- 3) The signage shall be located within the thirty (30) foot green space area and shall maintain appropriate sight triangle regulations in accordance with local ordinance.

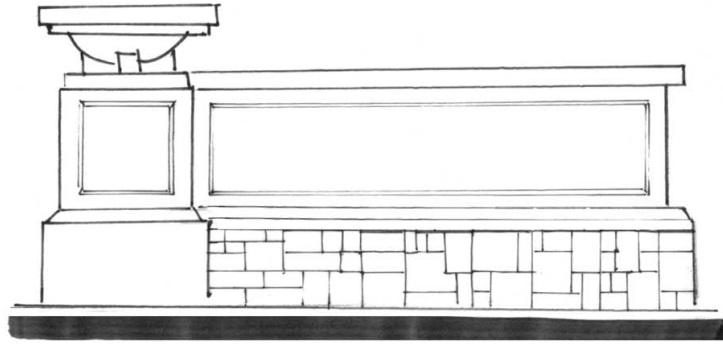

Figure 12: Example Secondary Gateway

P. Intersection Enhancements

1. All intersection enhancements shall be in accordance with the standards specified in the Ronald Reagan Corridor Design Guidelines Manual.
2. Pedestrian signals shall be installed at each intersection with a marked crosswalk.
3. Signalized intersections shall have marked crosswalks.
4. Marked crosswalks are strongly encouraged at non-signalized intersections.
5. Decorative paving and/or tactile surfaces are strongly encouraged at intersections and shall be in accordance with all Federal and State American Disabilities Act Standards.

Q. Bridge/Wall Treatments

1. Major Bridge
 - a. Bridges shall have enhancements including special wall treatments, parkway signage visible from the underpass, corridor lighting, and decorative railings and planters as specified in the Ronald Reagan Corridor Design Guidelines Manual and as illustrated in Figure 13, Example of Special Bridge Enhancements.
 - b. The bridge shall be well lit and shall contain a safe pedestrian passage in accordance with the standards specified in the Ronald Reagan Corridor Design Guidelines Manual.

- c. Bridges shall include a multi-use path at least twelve feet (12') in width. For additional multi-use path standards, see Section T and the standards specified in the Ronald Reagan Corridor Design Guidelines Manual.

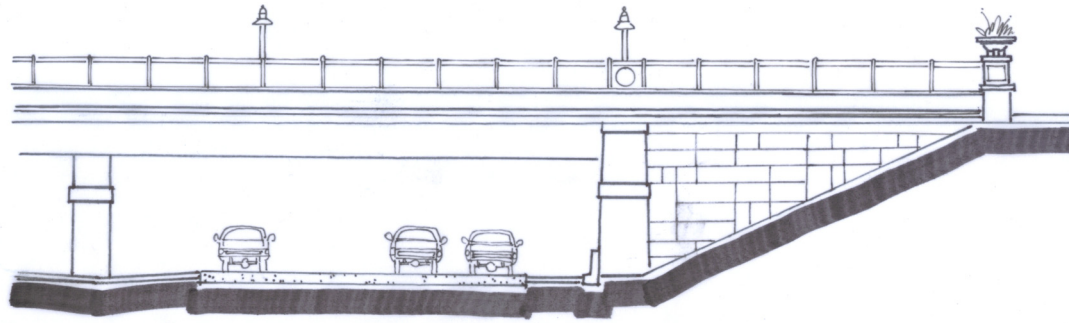

Figure 13: Example Special Bridge Enhancements

2. Minor Bridges

- a. The CSX bridge shall receive minor bridge treatments including corridor lighting consistent with the lighting standards of this Ordinance, decorative railings and planters developed in accordance with the standards specified in the Ronald Reagan Corridor Design Guidelines Manual.
- b. The bridge shall be well lit and shall contain a safe pedestrian passage in accordance with the standards specified in the Ronald Reagan Design Guidelines Manual.
- c. Bridges shall include a multi-use path at least twelve feet (12') in width. For additional multi-use path standards, see Section T and the standards specified in the Ronald Reagan Design Guidelines Manual.

3. Retaining Walls

- a. Retaining walls shall be utilized at entry drives for public and private establishments.
- b. Walls that are connected to buildings shall conform to the character of the building.
- c. Retaining walls that are not connected to buildings shall conform to the character of the Corridor as established in the Ronald Reagan

Corridor Master Plan and Design Guidelines by utilizing limestone and/or sandstone.

R. Lighting Requirements

A. Lighting Plan

A lighting plan for the proposed development within this Overlay District shall be filed as part of the development plan application, per Section B of this Ordinance.

B. Design

1. Lighting shall be configured in a manner that will not cause a false image of an aircraft runway. Where applicable and if in conflict with lighting standards for the airport or airport planning area, all FAA lighting standards shall prevail.
2. All lighting standards, including those on buildings, security lights and architectural lights within the Overlay District shall be of uniform design and material.
3. Parking lot and street lights shall also be of a uniform height not to exceed thirty (20) feet.
4. Lighting column foundations shall not extend more than 4" above the finished grade.
5. All fixtures with the exception of motion detector activated lighting shall be full cutoff and fully shielded.
6. Luminaries for such lights shall be in proportion to the pole diameter and height.
7. Lighting styles and designs shall be consistent with standards specified in the Ronald Reagan Design Guidelines Manual.

C. Intensity

All areas containing lighting shall limit light spillage onto adjacent property when measured at any point along a property line in accordance with the standards set forth below:

1. Lighting shall not cause illumination beyond any residential lot line or road right-of-way line in excess of 0.1 foot candles of light.

2. Lighting shall not cause illumination beyond any non-residential tract or parcel line or road right-of-way line in excess of 0.3 foot candles of light.
3. Compliance shall be achieved by utilizing fixture shielding, directional control designed into fixtures, fixture location, height, aim, or a combination of these or other factors.

S. Access to Individual Tracts

A. Access Restrictions

1. Consistent with the Ronald Reagan Corridor Master Plan, it is the intent of this ordinance to maximize safety and minimize disruption of traffic flow on the Ronald Reagan Parkway by directing access from abutting properties to existing or planned public streets that intersect with the Parkway.
2. Direct access to the Ronald Reagan Parkway shall be considered only where physical limitations and/or traffic impact studies show that there is no feasible option.
3. All median openings and traffic signals, if warranted, shall be at least one-half (1/2) mile apart in accordance with intersection space restrictions stated in the Ronald Reagan Corridor Master Plan.
4. Other access points, if approved, will be “right turn only” with no median opening.
5. The Ronald Reagan Parkway shall be an access managed highway, and access to individual tracts along this highway shall be gained by access roads if access does not exist.
6. In the Overlay District, common entrances shared by several properties and developments shall be required at the discretion of the Plan Commission.
7. In those cases where tracts can be accessed via connection to a primary or secondary arterial street as identified in the appropriate thoroughfare plan, a local street, or an adjoining parking lot, curb cuts shall not be established on the Ronald Reagan Parkway.
8. In order to preserve the aesthetic benefits provided by the green space area, access roads shall be provided at the rear of all tracts, whenever possible.
9. Access roads to contiguous tracts shall be coordinated so as to form one main access road serving adjoining developments. These roads should be designed so as to funnel traffic onto major arterial roads rather than into residential areas and roads that may adjoin or be near this Overlay District.

10. Access roads shall be designed to align with one another, where feasible.
11. The Plan Commission shall encourage maximum distances between curb cuts to the Ronald Reagan Parkway.

B. Traffic Impact Studies

Traffic Impact Studies shall be required for all new development proposed within the corridor that are expected to generate 100 or more new peak direction trips to or from the site. Traffic Impact studies shall meet the requirements of the local zoning ordinance. Specific traffic impact analysis requirements for individual developments shall be established with the Planning Director or his or her designee, with input from the County Engineer.

C. Design Standards

The design of drives, auxiliary (turn) lanes, tapers, paving blisters and other roadway elements shall be in compliance with local requirements for principal or primary arterials as identified in the local thoroughfare plan or Subdivision Control Ordinance. Entryways on cross streets shall comply with local requirements for the classification of the roadway being accessed.

T. Multi-Use Trail

1. A multi-use pathway shall be provided on the west side of the Ronald Reagan Parkway. The path shall be a minimum of twelve feet (12') in width and have a minimum twenty foot (20') buffer between the path and the roadway unless such a buffer is not feasible due to site constraints
2. The trail shall be designed and constructed in accordance to the standards specified in the Ronald Reagan Corridor Design Guidelines Manual and as shown in Figure 14, Section of Corridor with Multi-Use Path.
3. The path shall be connected to other planned or existing pathways to maximize opportunities for pedestrian circulation throughout the corridor. Pocket plazas associated with commercial or industrial uses are encouraged to establish links to the multi-use path. Mid-block pedestrian crossings are prohibited.
4. The multi-use path shall make accommodations for wheelchairs, bicyclists, strollers, and shall be in accordance with all applicable Federal and State American with Disabilities Standards. Decorative paving and/or tactile surfaces are encouraged at curb ramps and intersections.

5. Lighting along the multi-use path shall be pedestrian in scale and shall be in accordance with the standards specified in the Ronald Reagan Corridor Design Guidelines Manual. Wherever possible, shade trees shall be oriented to provide shade for the trail and pedestrian friendly elements such as water fountains, seating, and rest spots should be incorporated into the pathway.

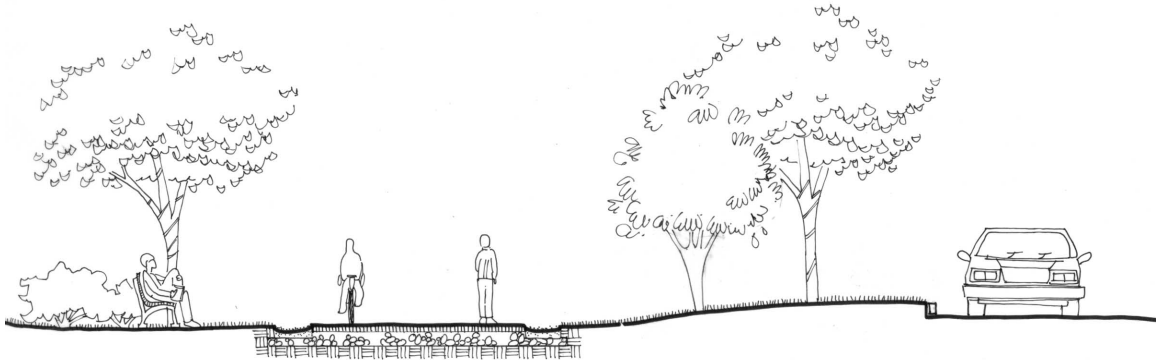

Figure 14: Section of Corridor with Multi-Use Path

U. Emergency Access

All emergency access areas and facilities shall be shown on the Site Plan and reviewed by the Fire Chief of the appropriate jurisdiction.

V. Other Requirements

In reviewing the other specified requirements identified below to be constructed in the Overlay District, the following factors shall be considered by the appropriate Plan Commission but are not limited to the following:

1. Outside Storage of Refuse
 - a. Unenclosed storage of refuse (whether or not in containers) or display of merchandise shall not be permitted on any property.
 - b. Refuse collection and recycling areas shall be in the rear of all buildings and limited from view by traffic along the Ronald Reagan Corridor. Trash receptacles shall be screened on three sides with a minimum six foot opaque wall consistent in materials with the primary structure or opaque plant materials as shown in Figure 15 and Figure 16, Screened Refuse Area.
 - c. All refuse collection containers shall be architecturally compatible with the principal building.

- d. No outside storage shall be permitted between an established Build-To Line and the Right-of-Way for the Ronald Reagan Parkway.



Figure 15: Screened Refuse Area



Figure 16: Screened Refuse Area

2. Loading Areas

- a. Loading areas are required per the regulations in the appropriate jurisdictions local ordinance and shall be identified on the development plan.
- b. Loading spaces and overhead doors shall be located at the rear or side of a building and shall be screened from view from the Parkway.
- c. Loading areas shall be screened using masonry wall(s), plant material, or a combination thereof as shown in Figure 17 and 18, Examples of Loading Area and, subject to Technical Review.



Figure 17: Example Loading Area



Figure 18: Example Loading Area

APPENDIX

Appendix 3

Recommended Plant Species Charts

RONALD REAGAN PARKWAY RECOMMENDED TREE SPECIES LIST

SMALL TREES WITH NARROW CROWNS

Acer griseum - Paperbark Maple
Amelanchier arborea - Shadblow Serviceberry
Amelanchier Canadensis 'Lamarcki' – Lamarcki Serviceberry
Amelanchier x grandiflora 'Robin Hill' – Robin Hill Serviceberry
Amelanchier laevis–Cumulus Serviceberry
Cornus kousa – Kousa Dogwood
Prunus sargentii 'Columnaris' –Columnar Sargent Cherry
Prunus serrulata – Oriental Cherry
Prunus virginiana 'Canada Red Select' – Canada Red Select Cherry

SMALL TREES WITH BROAD CROWNS

Acer buergeranum – Trident Maple
Acer campestre - Hedge Maple
Acer ginnala - Amur Maple
Acer tartarian - Tartarian Maple
Amelanchier laevis 'Cumulus'- Cumulus Serviceberry
Carpinus caroliniana - American Hornbeam
Cercis canadensis – Eastern Redbud
Chionanthus virginicus - Fringetree
Cornus alternifolia - Pagoda Dogwood
Cornus florida – Flowering Dogwood
Crataegus spp.– Hawthorn Varieties*: Inermis, Vaughn, Ohio Pioneer, Crimson Cloud, Winter King, Washington
Malus spp. - Crabapple Varieties *: Centzam, Red Splendor, Red Jewel, Van Eseltine, Zumi "See Indiana Urban Forest Council's recommended Crabapple list."
Prunus virginiana 'Shubert' - Shubert Chokecherry
Prunus 'Accolade' –Accolade Flowering Cherry
Syringa reticulata - Japanese Tree Lilac
 *limit use – over planted genus

MEDIUM TREES

Aesculus x carnea 'Briotii' - Rubyred Horsechestnut
Betula nigra - River Birch
Carpinus betulus - European Hornbeam
Fagus sylvatica 'Purpurea Tricolor' or 'Roseo-marginata' – Tricolor Beech
Gleditsia triacanthos inermis 'Impcole' – Imperial Honeylocust
Koelreuteria paniculata - Golden-Rain Tree
Nyssa sylvatica – Sourgum / Blackgum
Ostrya virginiana – Hophornbeam

*Limit use – overplanted genus

Phellodendron amurense 'Macho' - Male Corktree
Pyrus calleryana spp.- Pear Species
Quercus robur 'Fastigiata' - Pyramidal English Oak
Quercus robur 'Skyrocket' - Skyrocket English Oak
Sophora japonica - Pagodatree
Tilia cordata 'Corzam' - Corinthian Littleleaf Linden
Tilia x flavescens 'Glenleven' - Glenleven Hybrid Linden

LARGE TREES

Acer x freemanii – Autumn Blaze Maple
Acer nigrum - Black Maple
Acer platanoides–Norway Maple
Acer rubrum – Red Maple*
Acer saccharum – Sugar Maple
Carya ovata – Shagbark Hickory
Celtis laevigata 'All Seasons' - All Seasons Sugarberry
Celtis occidentalis 'Prairie Pride' - Prairie Pride Hackberry
Cercidiphyllum japonicum - Katsura Tree
Cladrastis kentukea - Yellowwood
Corylus colurna - Turkish Filbert
Eucommia ulmoides - Hardy Rubber Tree
Fagus grandifolia - American Beech
Fagus sylvatica - European Beech
Fraxinus americana - White Ash
Fraxinus pennsylvanica - Green Ash
Ginkgo biloba - Ginkgo (male only)
Gleditsia triacanthos inermis - Honeylocust
Gymnoclanus dioica - Kentucky Coffeetree
Liriodendron tulipifera - Tuliptree
Metasequoia glyptostroboides – Dawn Redwood
Platanus x acerifolia 'Bloodgood' - Bloodgood London Planetree
Platanus x acerifolia 'Columbia' - Columbia London Planetree
Platanus x acerifolia 'Liberty' - Liberty London Planetree
Quercus alba - White Oak
Quercus bicolor - Swamp White Oak
Quercus coccinea - Scarlet Oak
Quercus macrocarpa - Bur Oak
Quercus muehlenbergii - Chinkapin Oak
Quercus rubra - Northern Red Oak
Quercus velutina – Black Oak
Taxodium distichum - Bald Cypress
Tilia americana - American Linden
Tilia cordata – Littleleaf Linden

*Limit use – overplanted genus

Tilia tomentosa - Silver Linden
Ulmus parvifolia * - Chinese / Lacebark Elm
Ulmus parvifolia * 'Dynasty' - Dynasty Chinese Elm
Ulmus 'Pioneer' * - Pioneer Elm
*Ulmus x hollandica** 'Urban' – Urban Elm
*Zelkova serrata** – Japanese Zelkova

EVERGREEN TREES

Juniperus virginiana. – Red Cedar Juniper
Picea abies - Norway Spruce
Picea glauca – White Spruce
Picea omorika - Serbian Spruce
Picea pungens species - Colorado Blue Spruce
Pinus strobes - Eastern White Pine
Pinus nigra - Austian Pine
Tsuga Canadensis – Eastern Hemlock

UNDESIRABLE TREES

Acer negundo - Boxelder: Aggressive, Shallow roots, Weak wood
Acer Platanoides – Norway Maple: Invasive Indiana Plant
Acer saccharinum - Silver Maple: Aggressive, Shallow roots, Weak wood
Ailanthus altissima - Tree of Heaven: Seeds, Suckers, Weak wood, Invasive Indiana Plant
Betula papyrifera – Paper Birch: Insects
Betula pendula – European White Birch: Insects
Elaeagnus angustifolia - Russian Olive: Form, Disease
Fraxinus velutina glabra - Modesto Ash: Sidewalk damage problems
Ginkgo biloba - Female - Female Ginkgo: Fruits
Morus species - Mulberry: Fruits, Shallow roots, Invasive Indiana Plant
Pyrus calleryana 'Bradford' – Bradford Pear: Weak branching, Low branches
Populus alba - White Poplar: Suckers, Shallow roots, Weak wood
Populus deltoides - Cottonwood: Weak wood, Shallow roots, Seeds
Populus nigra 'Italica' - Lombardy Poplar: Insects, Disease, Short-lived
Quercus palustris – Pin Oak: Soil problems, Yellowing, Low branches
Quercus shumardii - Shumard Oak
Rhamnus cathartica, *Rhamnus frangula* – Buckthorns: Invasive Indiana Plant
Robinia pseudoacacia – Black Locust: Invasive Indiana Plant
Salix species - Willow: Weak wood, Shallow roots
Ulmus americana - American Elm: Insects, Disease
Ulmus pumila - Siberian Elm: Weak wood, Seeds, Invasive Indiana Plant

*Limit use – overplanted genus

RONALD REAGAN PARKWAY RECOMMENDED SHRUB SPECIES LIST

Scientific Name Common Name	Evergreen?	Average Height	Growth Rate	Form	Sunlight Requirement	Soil Moisture Requirement	Comments
<i>Aesculus parviflora</i> Bottlebrush Buckeye	N	8' to 10'	Fast	Irregular	Full sun to Partial shade	Moist	Native Shrub
<i>Amelanchier arborea</i> , <i>A. canadensis</i> , <i>A. laevis</i> Serviceberry Species and Hybrids	N	12' to 20'	Moderate	Irregular	Full sun to Partial shade	Moderate	Use multiple stem specimens for when used as shrub
<i>Aronia arbutifolia</i> Red Chokeberry	N	4' to 6'	Slow	Upright Irregular	Full sun to Partial shade	Moderate	
<i>Aronia melanocarpa</i> Black Chokeberry	N	4' to 5'	Moderate	Irregular Spreading	Full sun to Partial shade	Moderate	Native Shrub
<i>Baptisia australis</i> ; <i>B. leucantha</i> Blue False Indigo; White False Indigo	N	3' to 5'	Moderate	Irregular	Full sun to Partial shade	Moderate to Dry	Native Prairie Plant
<i>Berberis thunbergii</i> Japanese Barberry	N	18" to 5' Varies by cultivar	Moderate	Rounded Spreading	Full sun	Moderate	Good barrier plant; however, thorniness makes clean up difficult. Traps leaves and litter. Cultivars: 'Crimson Pygmy', 'Rosy Glow'
<i>Buxus koreana x Buxus sempervirens</i> Sheridan Hybrid Boxwood	Y	2' to 5' Varies by cultivar	Slow	Rounded	Partial shade to Sun	Moderate	Cultivars: 'Green Gem', 'Wintergreen', 'Green Velvet', 'Green Mountain', etc.
<i>Calycanthus floridus</i> Sweetshrub	Y	4' to 7'	Moderate	Irregular Spreading	Full Sun	Moderate	
<i>Caryopteris x clandonensis</i> Blue Mist Spirea	N	3'	Fast	Rounded	Full Sun	Moderate to Dry	
<i>Ceanothus americanus</i> New Jersey Tea	N	2'	Fast	Rounded	Full Sun to Partial Shade	Moderate to Dry	Native Shrub
<i>Chaenomeles speciosa</i> cultivars Flowering Oriental Quince	N	6' to 10'	Moderate	Rounded Spreading	Full Sun	Moderate	Good barrier plant; however, thorniness makes clean up difficult. Traps leaves and litter. Cultivars: 'Texas Scarlet', 'Jet Trail', & Other hybrids
<i>Clethra alnifolia</i> Summersweet	N	3' to 8' Varies by cultivar	Moderate	Rounded	Full Shade	Wet to Moderate	

RONALD REAGAN PARKWAY RECOMMENDED SHRUB SPECIES LIST - CONT'D

<i>Cornus alba</i> ; <i>Cornus sericea</i> Tatarian Dogwood ; Redtwig Dogwood	N	5' to 10'	Fast	Upright Irregular	Partial shade	Moderate	
<i>Cotoneaster apiculata</i> , <i>C. divaricata</i> , <i>C. lucida</i> Cotoneaster	N	3' to 8'	Slow to Moderate	Spreading	Full Sun	Moderate	Cultivars: Tom Thumb Creeping Cotoneaster, Cranberry, Coral Beauty, etc.
<i>Forsythia x intermedia</i> Common Forsythia	N	12" to 10' Varies by cultivar	Fast	Irregular, varies by cultivar	Partial shade to Full sun	Moderate	Cultivars: 'Sunrise', 'Gold tide', 'Bronx', etc.
<i>Hamamelis vernalis</i> Vernal Witch Hazel	N	10' to 12'	Moderate	Irregular	Partial shade	Moderate	
<i>Hydrangea macrophylla</i> Bigleaf Hydrangea	N	3' to 5'	Moderate	Rounded	Full sun to Partial shade	Wet to Moderate	
<i>Hydrangea paniculata</i> PeeGee Hydrangea	N	6' to 10'	Moderate	Rounded	Full sun to Partial shade	Wet to Moderate	
<i>Hydrangea quercifolia</i> Oakleaf Hydrangea	N	4' to 8'	Slow to Moderate	Upright Irregular	Full Shade to Sun	Moist	Native shrub
<i>Ilex crenata</i> Japanese Holly	Y	3' to 4'	Slow	Rounded	Partial Shade	Moderate	Cultivars: 'Compacta', 'Convexa', 'Helleri', 'Hetzi'
<i>Ilex glabra</i> Compact Inkberry	Y	4' to 6'	Slow	Irregular	Full sun to Partial shade	Wet to Moderate	Native Shrub
<i>Ilex meserveae</i> Meserveae Holly	Y	5' to 10'	Moderate	Rounded to Upright	Partial shade to Full sun	Moderate	
<i>Ilex verticillata</i> Winterberry Holly	N	6' to 10'	Slow to Moderate	Rounded	Partial shade to Full sun	Wet to Moderate	Native Shrub
<i>Juniperus (Shrub forms)</i> Juniper	Y	12" to 8' Varies by cultivar	Slow to Moderate	Varies by cultivar	Full sun	Moderate to Dry	Cultivar: 'Blue Pacific', 'Sea Green', 'Kallays Compact', 'Blue Chip', etc.
<i>Myrica pensylvanica</i> Northern Bayberry	N	8' to 10'	Moderate	Rounded	Partial shade to Full sun	Moderate to Dry	Tolerates road salt
<i>Physocarpus opulifolius</i> Common Ninebark	N	4' to 7'	Moderate	Irregular	Full sun	Moderate to Wet	Native Shrub
<i>Picea abies (Shrub forms)</i> Norway Spruce	Y	2' to 8' Varies by cultivar	Fast	Varies by cultivar	Full Sun	Moderate	

RONALD REAGAN PARKWAY RECOMMENDED SHRUB SPECIES LIST- CONT'D

<i>Picea glauca</i> (Shrub forms) Dwarf Alberta Spruce	Y	3' to 8' Varies by cultivar	Slow	Varies by cultivar	Full sun	Moderate	
<i>Pinus mugo</i> Mugho Pine	Y	4' to 6'	Slow	Rounded	Full sun	Moderate to Dry	
<i>Potentilla fruticosa</i> Potentilla	N	2' to 3'	Slow	Rounded	Full sun	Moderate	
<i>Pyracantha coccinea</i> Scarlet Firethorn	Y	6' to 10'	Moderate to Fast	Rounded to Irregular	Partial shade to Full sun	Moderate	
<i>Rhus aromatica 'Lo Grow'</i> Low Grow Sumac	N	1' to 2'	Moderate	Spreading	Full sun	Moderate	Native groundcover
<i>Spiraea speciosa</i> cultivars Spirea	N	2' to 6'	Moderate	Rounded	Full sun to Partial shade	Moderate	Cultivars: 'Gold Mound', 'Shiro Bana', 'Snow Mound', 'Little Princess', etc.
<i>Syringa meyeri</i> Dwarf Korean Lilac	N	3' to 5'	Moderate	Rounded	Full sun	Moderate	Cultivars: 'Palibin'
<i>Syringa patula 'Miss Kim'</i> Miss Kim Lilac	N	6' to 10'	Moderate	Rounded	Full sun	Moderate	
<i>Taxus x media</i> Common Yew	Y	3' to 8' Varies by cultivar	Slow	Varies by cultivar	Partial shade	Moderate	
<i>Thuja occidentalis 'Emerald'</i> Emerald Arborvitae	Y	10-12'	Moderate	Pyramidal	Full sun to Partial shade	Moist to Wet	
<i>Viburnum carlesii</i> , <i>V. cassinoides</i> , <i>V. dentatum</i> , <i>V. dilatatum</i> , <i>V. lantana</i> , <i>V. lentago</i> , <i>V. plicatum</i> , <i>V. rhytidophylloides</i> , <i>V. rhytidophyllum</i> Viburnum Species and Cultivars	N	6' to 12' Varies by type	Slow to Moderate	Varies by type	Partial shade to Full sun	Moderate	
<i>Viburnum lentago</i> , <i>V. prunifolium</i> , <i>V. trilobum</i> Native Viburnums	N	6' to 12' Varies by type	Slow to Moderate	Varies	Partial shade to Full sun	Moderate	Common names: Nannyberry, Blackhaw, American Cranberry Bush

APPENDIX

Appendix 4

Land Use Recommendations: 56th Street to Hendricks/Boone County Line

LAND USE RECOMMENDATIONS: 56TH ST. TO HENDRICKS/BOONE CO. LINE

During the master planning process, Hendricks County Commissioners met with the Boone County Commissioners about extending the roadway to Interstate 65 north of Hendricks County. In response, the design team was tasked with preparing a 4 mile extension of the project which focused on land use planning for the 4 miles north of 56th Street at the northern end of the study limits to the Hendricks County line. This exercise focused on developing a land use plan that supports the goals of the Ronald Reagan Master Plan by promoting the corridor as a premier business address and the continuation of design standards set forth in the Ronald Reagan Corridor Master Plan. It is anticipated that these planning efforts will eventually continue and future studies will examine the connections extending further into Boone County and connecting to I-65.

The future planning of this four mile extension is important because development pressures are anticipated in the long term, and proper planning will help to ensure a corridor that meets the goals and needs of the local communities. Immediate development pressures from Brownsburg will drive much of the development likely to occur up to 750N and eventually further north along the corridor. In addition, long term development pressures are anticipated as a result of growth from the City of Indianapolis as well as the planned new-town development Anson at I-65. Anson will stimulate the development of homes, offices, retail, and light manufacturing that will likely trickle down the corridor from Boone County.

Because much of this 4 mile segment is not likely to face immediate development pressures, it was determined that the land use plan should promote the long term vision of the corridor, while still allowing flexibility in its use designations. Two land use plans have been developed based on the current and anticipated development pressures along these portions of the corridor.

LAND USE PLAN: 56TH Street to 750N

The first land use plan extends from 56th Street to 750N. This area, because of its proximity to I-74, is facing more immediate development pressures than areas further to the north. The plan calls for an institutional campus at the site of future schools, a commercial node at 56th Street, natural areas, and some residential developments which have been slated to occur. This land use plan for areas south of 750N is illustrated in the figure below.

FIGURE A4.1: Land Use Plan- 56th Street to 750N

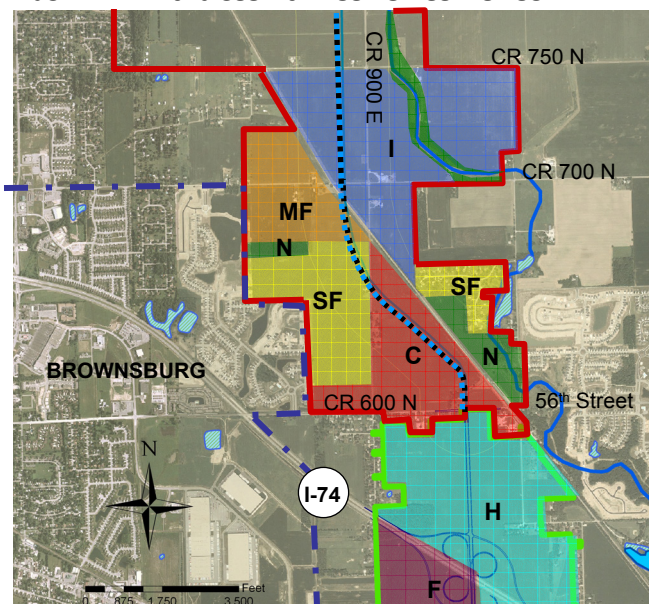

Land Uses:

- C Commercial
- SF Single-family
- I Institutional/Office/School Campus
- N Natural Areas/ Park
- MF Multi-family
- H Hospitality
- F Flex

LONG TERM VISION PLAN: 750N to COUNTY LINE

Land use planning north of 750N focuses on a bigger picture vision. Because of the lack of immediate development pressures, this scheme was developed to allow more flexibility. The long term vision for areas north of 750N to the County line is illustrated to the right. This plan designates land uses in the broader terms of regional employment areas and residential communities. Guidelines have been set for each type of land use designation.

Some portions have been set aside as residential communities in order to meet a demand for residential growth pressures from Brownsburg. In addition, residents will benefit from close proximity to local schools and convenient access to I-74. In keeping with the goals of the master plan, no low density residential development will be permitted in these areas.

The bulk of the corridor is designated as regional employment areas. These areas will provide lower-intensity development such as low scale office, warehouse, and flex space. This decision is in keeping with the goal of the master plan to establish a premier economic address along the corridor. All new residential uses will be excluded in these areas.

- 1 REGIONAL EMPLOYMENT AREAS**
 - Encourage non-residential lower-intensity development such as low scale office, warehouse, flex-space
 - Exclude all new residential uses
 - Promote economic development that supports the goals of the master plan

- 2 RESIDENTIAL COMMUNITIES**
 - Helps to meet a demand for residential growth pressures from Brownsburg
 - Convenient access to I-74
 - Encourage medium density residential development (no low density development)
 - Establish connection to schools and Greenways

- POTENTIAL PARKS/ NATURAL AREAS**

FIGURE A4.2: Long-Term Vision Plan- 750N to County Line

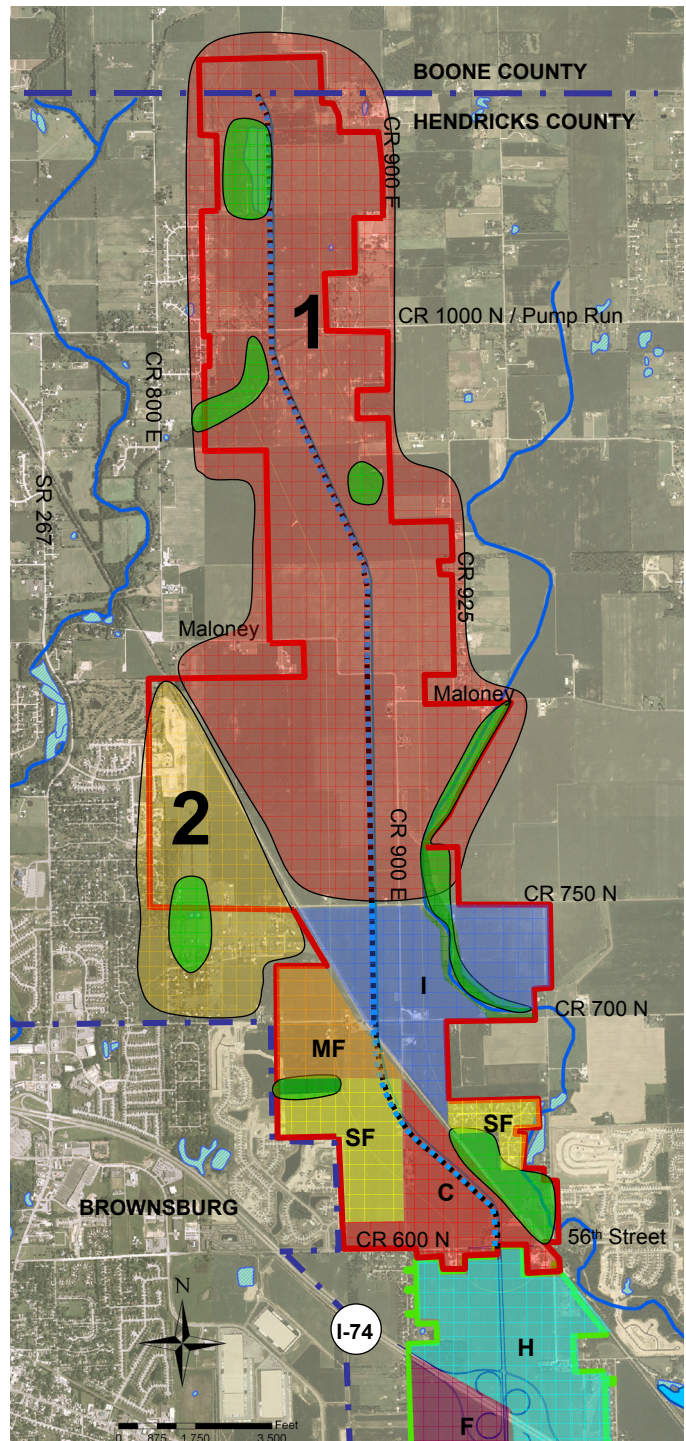

LAND USE RECOMMENDATIONS: 56TH ST. TO HENDRICKS/BOONE CO. LINE

During the master planning process, Hendricks County Commissioners met with the Boone County Commissioners about extending the roadway to Interstate 65 north of Hendricks County. In response, the design team was tasked with preparing a 4 mile extension of the project which focused on land use planning for the 4 miles north of 56th Street at the northern end of the study limits to the Hendricks County line. This exercise focused on developing a land use plan that supports the goals of the Ronald Reagan Master Plan by promoting the corridor as a premier business address and the continuation of design standards set forth in the Ronald Reagan Corridor Master Plan. It is anticipated that these planning efforts will eventually continue and future studies will examine the connections extending further into Boone County and connecting to I-65.

The future planning of this four mile extension is important because development pressures are anticipated in the long term, and proper planning will help to ensure a corridor that meets the goals and needs of the local communities. Immediate development pressures from Brownsburg will drive much of the development likely to occur up to 750N and eventually further north along the corridor. In addition, long term development pressures are anticipated as a result of growth from the City of Indianapolis as well as the planned new-town development Anson at I-65. Anson will stimulate the development of homes, offices, retail, and light manufacturing that will likely trickle down the corridor from Boone County.

Because much of this 4 mile segment is not likely to face immediate development pressures, it was determined that the land use plan should promote the long term vision of the corridor, while still allowing flexibility in its use designations. Two land use plans have been developed based on the current and anticipated development pressures along these portions of the corridor.

LAND USE PLAN: 56TH Street to 750N

The first land use plan extends from 56th Street to 750N. This area, because of its proximity to I-74, is facing more immediate development pressures than areas further to the north. The plan calls for an institutional campus at the site of future schools, a commercial node at 56th Street, natural areas, and some residential developments which have been slated to occur. This land use plan for areas south of 750N is illustrated in the figure below.

FIGURE A4.1: Land Use Plan- 56th Street to 750N

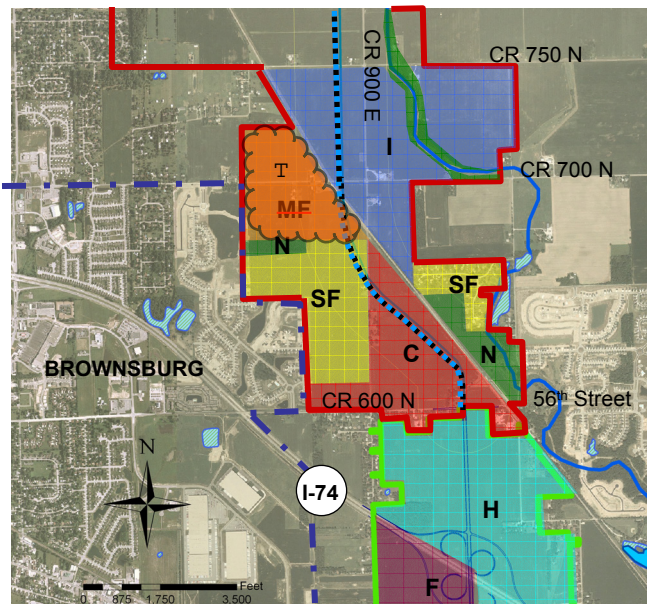

Land Uses:

- C** Commercial
- SF** Single-family
- I** Institutional/Office/School Campus
- N** Natural Areas/ Park
- T MF** Multi-family Transitional
- H** Hospitality
- F** Flex

LONG TERM VISION PLAN: 750N to COUNTY LINE

Land use planning north of 750N focuses on a bigger picture vision. Because of the lack of immediate development pressures, this scheme was developed to allow more flexibility. The long term vision for areas north of 750N to the County line is illustrated to the right. This plan designates land uses in the broader terms of regional employment areas and residential communities. Guidelines have been set for each type of land use designation.

Some portions have been set aside as residential communities in order to meet a demand for residential growth pressures from Brownsburg. In addition, residents will benefit from close proximity to local schools and convenient access to I-74. In keeping with the goals of the master plan, no low density residential development will be permitted in these areas.

The bulk of the corridor is designated as regional employment areas. These areas will provide lower-intensity development such as low scale office, warehouse, and flex space. This decision is in keeping with the goal of the master plan to establish a premier economic address along the corridor. All new residential uses will be excluded in these areas.

- 1 REGIONAL EMPLOYMENT AREAS**

 - Encourage non-residential lower-intensity development such as low scale office, warehouse, flex-space
 - Exclude all new residential uses
 - Promote economic development that supports the goals of the master plan

- 2 RESIDENTIAL COMMUNITIES**

 - Helps to meet a demand for residential growth pressures from Brownsburg
 - Convenient access to I-74
 - Encourage medium density residential development (no low density development)
 - Establish connection to schools and Greenways

- POTENTIAL PARKS/ NATURAL AREAS**

FIGURE A4.2: Long-Term Vision Plan- 750N to County Line

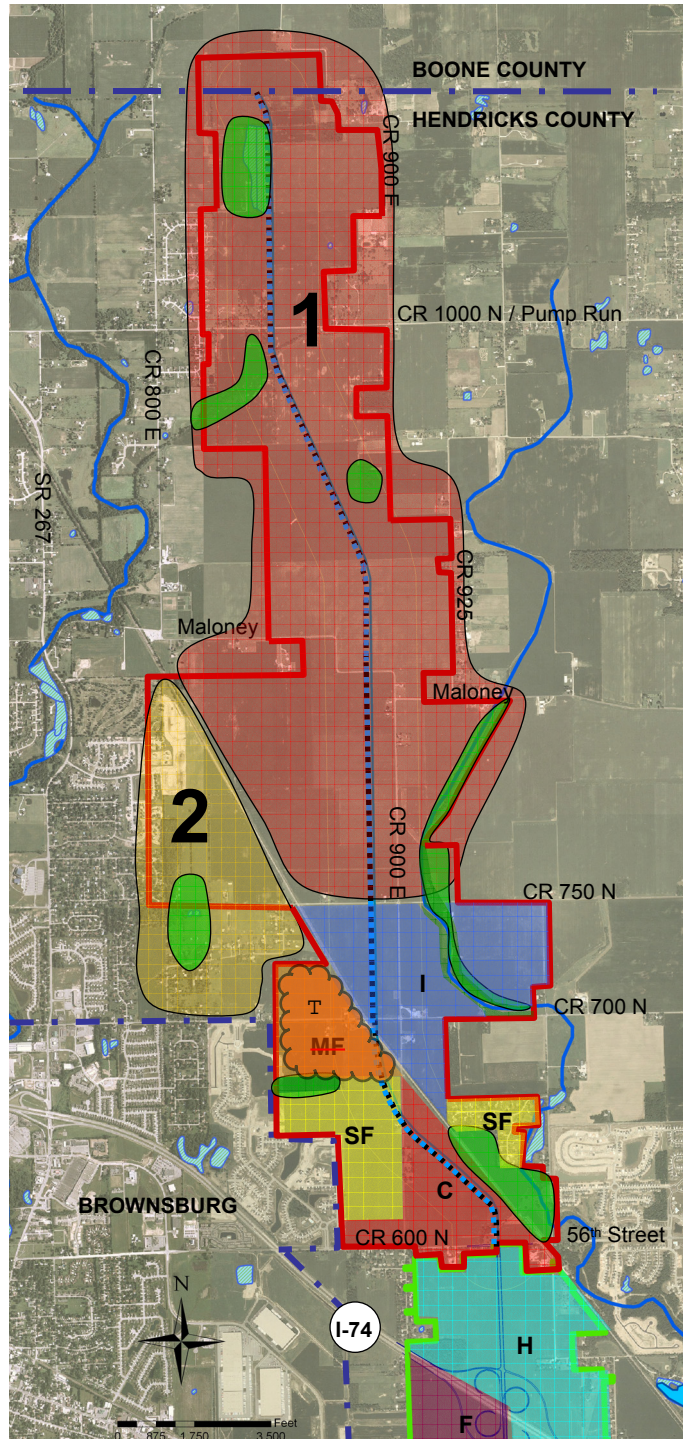

**Model Ordinance
Ronald Reagan Corridor Overlay District**

Purpose, Intent and Authority

It is the purpose of the Ronald Reagan Corridor Overlay District (herein referred to as the “Overlay District”) to promote and protect the public health, safety, comfort, convenience and general welfare by providing for the consistent and coordinated treatment of the properties bordering the Ronald Reagan Parkway in Hendricks County, Indiana.

The Plan Commissions, Town Councils, and County Commissioners, in establishing this district, are relying on IC-36-7-4-600 et. seq. and IC 36-7-4-1400 et. seq. This overlay district is, intended to serve as a tool for implementing the development policies and guidelines set forth in the Ronald Reagan Corridor Master Plan. The Ronald Reagan parkway is a limited access highway and an important economic development corridor to the Towns of Avon, Plainfield, and Brownsburg and Hendricks County. The Ronald Reagan corridor is a premier location and employment center whose viability, quality, and character are important to the community as a whole, adjacent residents, employees, business owners and taxing districts. Therefore, it is the further purpose of the Ronald Reagan Corridor Overlay District:

- To preserve the integrity of the road function through access management planning;
- To maximize the opportunity to create high level development through sound land use planning; and,
- To create a premier economic address in Hendricks County and the Towns of Avon, Plainfield, and Brownsburg through the development of aesthetic standards which make the corridor appear as a planned twelve-mile campus.

A. District Boundaries

The boundaries of the Overlay District are hereby established as shown on the attached map for Hendricks County, in the State of Indiana. The study area shall include the parkway alignment running north and south through Hendricks County, and adjacent properties within approximately 1000 feet on either side of the proposed parkway centerline as shown on Figure 1, District Boundary.

The Official Zone Maps for the Town of Avon, the Town of Plainfield, the Town of Brownsburg, and Hendricks County, in the State of Indiana are officially amended by the adoption of this Ordinance to include the Overlay District per the boundaries set forth.

If a portion of a parcel should fall within this identified boundary, the whole parcel shall be subject to the master plan and overlay district standards set forth for the corridor.

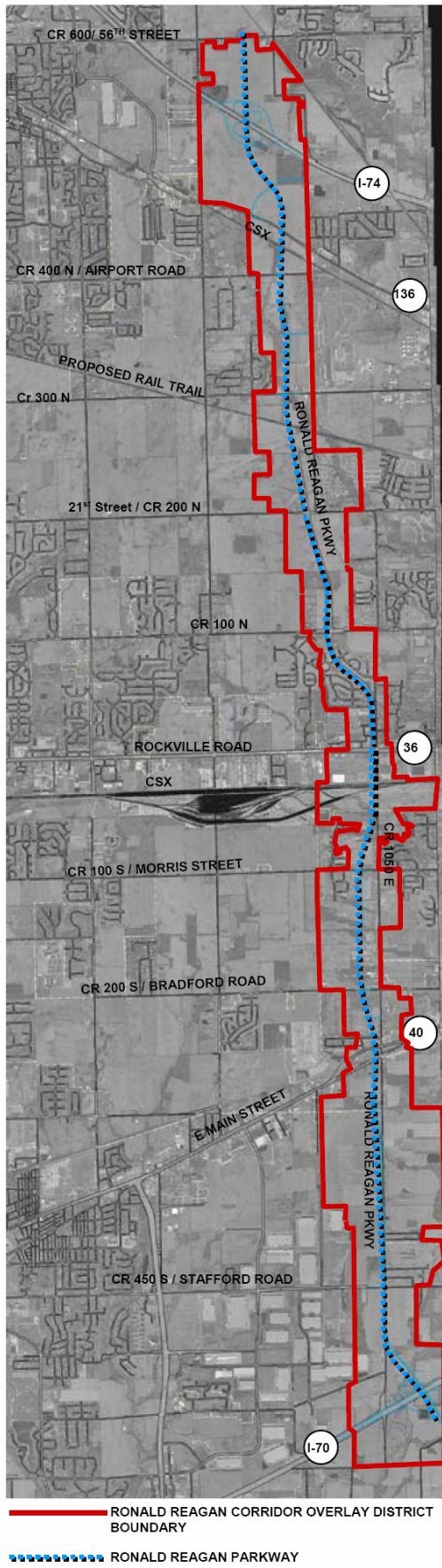

Figure 1: District Boundary

B. Plan Commission Approval

The appropriate Plan Commission body must approve, approve with conditions, or disapprove the development plan for any tract of land in the Overlay District per the provisions of this Ordinance. All development plans should adhere to the requirements set forth by the appropriate jurisdiction.

1) Application Procedure

See the appropriate local zoning ordinance for application requirements.

2) Findings for Approval by the Plan Commission

The appropriate Plan Commission may approve a Development Plan upon finding that:

- a. The Development Plan complies with all applicable Development Standards of the underlying district in which the site is located;
- b. The Development Plan complies with all applicable provisions of the appropriate Subdivision Control Ordinance;
- c. The Development Plan complies with all applicable provisions of the Overlay District;
- d. The proposed development is appropriate to the site and its surroundings; and
- e. The proposed development is consistent with the intent and purpose of this Ordinance and the Ronald Reagan Corridor Master Plan.

3) Validity of Approval of the Application by the Plan Commission

An approved development plan petition shall be valid for two (2) years from the date of approval. If construction of the building(s) has (have) not started at the end of the two (2) year period, the development plan request shall be re-submitted to the appropriate Plan Commission for consideration and disposition.

4) Removal of a District

Nothing in this Ordinance shall be deemed to deny the appropriate Plan Commission the power to remove an Overlay designation from one or more parcels in the proper case by the rezoning process described in the local zoning ordinance. Such removal may be done by rezoning the property to the underlying district classification “without the Ronald Reagan Corridor

Overlay District,” and may be subject to such conditions as may be voluntarily proffered and approved pursuant to local Ordinance.

C. Overlay Applicability

This district is created as a special overlay district to be superimposed on base districts by approval of the Town Councils and County Commissioners as appropriate. Boundaries of this overlay are shown on the zoning district map for each jurisdiction. Development standards provided herein are intended to supplement those permitted in the underlying zoning classification and in most cases may be more restrictive than those of the underlying zoning classification. When the requirements of the underlying zoning district or a local overlay district and the Overlay District appear to be in conflict, the more restrictive shall apply.

D. Definitions

Build-to line – An alignment established a certain distance from the right-of-way line to a line along which the building shall be built. Front porches and handicap ramps shall be exempt from build-to line requirements, and must occur behind the property line.

Façade – That portion of any exterior elevation on the building extending from grade to top of parapet, wall, or eaves and the entire width of the building elevation.

Flex Space – A building, usually prefabricated, that provides the appearance of a “store front” with a designated use and generally includes an additional use located within the back of a building. Typically these buildings are designed to be multi-functional containing office or retail space in the front of the building along the “store front” while other uses including office, retail, warehousing or light manufacturing are located in the rear of the building, hidden by the “store front” use.

Development Plan – Also referred to as Site Development Plan or Site Plan. A detailed plan, prepared in accordance with the rules and regulations of the appropriate jurisdiction, and submitted to the Plan Commission or other designated body or authority for review and approval. The plan shall illustrate the proposed development or alterations of a site.

Green Space Area – That portion of the front yard of a lot that is immediately adjacent and parallel to the street right-of-way of the Ronald Reagan Parkway and all other Roads within the identified boundaries.

Major Gateways - Regional gateways where major traffic thoroughfares intersect with the Ronald Reagan Parkway. For purposes of this project, these are located where the parkway meets the interchanges at I-70 and I-74.

Median Nose - The tip of a median at its terminus of traffic opening.

Overlay District – A district established by ordinance to prescribe special regulations to be applied to a site in combination with the underlying or base district.

Parapet – That portion of a wall which extends above the roof line.

Ronald Reagan Corridor – A 16 mile limited access highway and economic development area running north and south through Hendricks County, Indiana beginning at I-70, connecting the Towns of Avon, Plainfield, and Brownsburg to the Boone County Line. The corridor incorporates adjacent properties radiating out approximately 1000 feet on either side of the proposed parkway centerline.

Ronald Reagan Parkway – A 16 mile roadway alignment running north and south through Hendricks County, Indiana, beginning at I-70 connecting the Towns of Avon, Plainfield, and Brownsburg to the Boone County Line.

Secondary Gateways - Entries to public and private establishments and/or developments.

Sign, free standing – A sign anchored directly to the ground or supported by one or more posts, columns or other vertical structures or supports, and not attached to or dependent on support from any building.

Sign, monument – A free standing sign supported primarily by an internal structural framework and has its sign face or base on the ground with no air space, columns or supports visible between the ground and the bottom of the sign. Monument signs are also referred to as secondary gateways.

Sign, off-premise – A sign that directs attention to a business, commodity, service, or entertainment to a separate location not related to the premises where such sign is located or to which it is affixed.

Sign, unified centers - One sign which contains multiple smaller signs integrated into a free standing sign indicating the presence of multiple tenants on a property being constructed or managed as a single development. Such developments include, but are not limited to: shopping centers, strip malls, office parks and industrial parks.

Sign, wall – A sign mounted flat against and projecting less than fourteen (14) inches from, or painted on the wall of, a building or structure with the exposed face of the sign in a plane parallel to the face of the wall. This does not include window signs.

E. Permitted Uses

All uses which are permitted in a given site's underlying primary zoning district, except those uses expressly excluded in Section G of this Ordinance, are permitted in the Overlay District.

F. Permitted Special Exceptions

All special exceptions, which are permitted (upon obtaining the grant of a special exception from the appropriate Board of Zoning Appeals) in the underlying primary zoning district(s), except the uses expressly excluded in Section G, of this Ordinance, are permitted in the Overlay District.

G. Excluded Uses

The following uses are prohibited in the Overlay District.

1. Adult Business;
2. Amusement park/ go-cart track;
3. Automotive graveyard;
4. Bulk storage of petroleum products not used for on-site manufacturing;
5. Car rental agencies;
6. Cell towers and other wireless communication facilities;
7. Commercial Car and truck washes as a principal use;
8. Confined feeding operations;
9. Explosives manufacturing;
10. Fertilizer manufacturing, stock yards, slaughtering, leather curing and tanning;
11. Filling stations;
12. Garbage disposal plant/sanitary landfill;
13. Incineration for reduction of refuse;
14. Jail;
15. Junk or salvage yard;
16. Long-term surface parking;
17. Manufactured home dwelling sales;
18. Mineral extraction;
19. Mobile home park;
20. Ordinance products;
21. Outdoor sales;
22. Outdoor storage, with the exception of propane tanks. Propane tanks shall not be in the front yard between the roadway and the building unless otherwise screened with plant materials.
23. Penal or correctional institution;
24. Petroleum refining;
25. Reclaiming processes involving materials or chemicals that are considered dangerous to the health, safety, and welfare of the general public as determined by the State Board of Health or by the Hendricks County;

26. Refining or manufacturing of asphalt, cement, gypsum, lime, or wood preservatives;
27. Refining or manufacturing of petroleum products;
28. Roadside sales stand;
29. Sand and gravel extraction or sales;
30. Single-family residential uses;
31. Storage or disabled vehicles;
32. Vehicle sales; and
33. Waste transfer stations.

H. Accessory Buildings and Uses

All accessory buildings and uses which are permitted in the underlying zoning district(s) shall be permitted, except that any detached accessory building in any development plan shall be architecturally compatible with the primary building(s) with which it is associated.

I. Minimum Lot Area

The minimum lot area required within the Overlay District is 10,000 square feet for non-residential uses with sewer and 24,000 square feet for non-residential uses without sewer. All lots within the Overlay District shall be subject to development plan approval. For lots located only partially within the Overlay District, a development plan shall be submitted to the appropriate Plan Commission for the entire tract to be developed.

If a parcel of land or subdivision lot was recorded prior to the effective date of this Ordinance, and said parcel of lot does not contain the minimum lot area required by this paragraph, said parcel or lot ("Undersized Lot") may be used for any use permitted in the Overlay District provided that:

- a. At the time of recordation of the undersized lot or on the effective date, the undersized lot met the requirements for minimum lot area then in effect for a lot in the underlying primary zoning district(s).
- b. The owner of the undersized lot must include, up to the minimum tract size, any adjoining vacant land (not separated by a street or public way) owned, or owned by an affiliate, on or before the effective date or at the time of application which, if combined with the undersized lot, would create a tract which conforms, or more closely conforms, to the minimum tract size requirements of this Paragraph; and,
- c. Other Development Requirements Applicable to the Overlay District

This Paragraph does not preclude the sale or other transfer of any parcel of land within a tract after the approval of a development plan for the entire tract. However, the development of the parcel must still conform to the development

plan for the entire tract as approved or amended by the appropriate Plan Commission, and all other applicable requirements contained in this Ordinance.

J. Development Requirements

1. Build-To Line

All lots located within the Overlay District that contain lot frontage adjacent to the Ronald Reagan parkway shall have their principal building located on the Build-To Line. The Build-To Line is a invisible line parallel to the Ronald Reagan Parkway that shall allow for a uniform setback and view of the corridor along the parkway. The Build-To Line shall be one hundred (100) feet from the edge of the Ronald Reagan Parkway Right-of-Way as illustrated in Figure 2, Build-To Line.

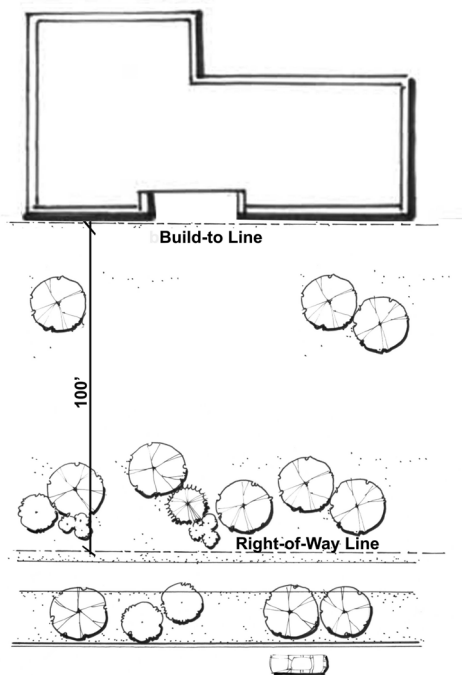

Figure 2: Build-To Line

2. Green Space Area

All lots within the Overlay District shall contain a Green Space Area. Refer to Section M, Subsection 2.a. of this ordinance for specific requirements.

3. Remodel, Expansion or Improvement of Existing Structure or Parcels

If a parcel fronts the Ronald Reagan Parkway and is improved or an existing structure is expanded or remodeled within the Overlay District, then that parcel or structure shall be subject to the regulations contained in this Ordinance.

K. Architectural Design Requirements – Commercial and Industrial

In reviewing the architectural design of commercial and industrial building(s) proposed to be built in the Overlay District, factors to be considered by the appropriate Plan Commission shall include but are not limited to the following:

1. Context

All buildings shall be designed with respect to the general character of the Ronald Reagan Corridor as defined in the Ronald Reagan Corridor Master Plan and, particularly, with due consideration to buildings located on the lots that abut the project site.

2. Massing

- a. A single, large, dominant structure mass shall be avoided in new buildings and, to the extent reasonably feasible, in development projects involving changes to the mass of existing buildings.
- b. Changes in mass shall be related to entrances, the integral structure and/or the organization of interior spaces and activities and not merely for cosmetic effect. False fronts or parapets create an insubstantial appearance and are prohibited.

3. Façade Treatment

- a. Facades along the Ronald Reagan Parkway frontage shall add architectural interest and variety and avoid the effect of a single, long or massive walls with no relation to human scale. No wall that faces a street or connecting walkway shall have a blank, uninterrupted length exceeding fifty feet without including, but not be limited to, at least two of the following:
 - 1) Change in plane,
 - 2) Change in texture or masonry pattern,
 - 3) Windows, trellis with vines, or
 - 4) An equivalent element.
- b. Facades greater than one hundred feet in length, measured horizontally, shall incorporate wall plane projections or recesses having a depth of at least three percent of the length of the façade and extending at least twenty percent of the length of the façade. No interrupted length of any façade shall exceed one hundred horizontal feet.
- c. Horizontal masses shall not exceed a height to width ratio of 1:3 without substantial variation in massing that includes a change in height and projecting or recessed elements.

- d. Building facades must include a repeating pattern that includes any one or more of the following elements.
 - 1) Color changes
 - 2) Texture change; and/or
 - 3) Material module change
- e. Facades shall have an expression of architectural or structural bays through a change in plane no less than twelve inches in width, such as an offset, reveal or projecting rib.
- f. Facades shall have at least one of the elements of subsections 3. a, b, c or d of this section that repeat horizontally. All elements shall repeat at intervals of no more than thirty feet, either horizontally or vertically.

4. Roofs

All facades shall have a recognizable “top” consisting of at least one element below:

- a. Parapets concealing flat roofs and rooftop equipment all or partially from public view. The average height of such parapets shall not exceed fifteen percent of the height of the supporting wall and such parapets shall not at any point exceed one-third of the height of the supporting wall. Such parapets shall feature three-dimensional cornice treatment;
- b. Overhanging eaves, extending no less than three feet past the supporting walls;
- c. Sloping roofs that do not exceed the average height of the supporting walls, with an average slope of greater than or equal to one foot of vertical rise for every three feet of horizontal run and less than or equal to one foot of vertical rise for every one foot of horizontal run; or
- d. Three or more roof slope planes.

5. Entryways

Use creative entry treatments and other focal points such as canopies, awnings, cornice treatments or atriums.

6. Building Elements & Accessory Structures

- a. Separate building elements or accessory structures should be designated as an integral part of the building design.

- b. Use signs that are complementary to and integrated with building design so that they do not dominate facades or appear tacked on.
 - c. Screen appurtenances or design them as integral parts of the buildings so that they are not visible from the street.
 - d. Screen docks, garage doors and service areas to minimize their visibility from adjacent streets.
7. Site Design and Relationship to Surrounding Community
- a. Building sites shall contribute to the establishment or enhancement of community and public spaces by providing at least two of the following:
 - 1) Patio/seating area;
 - 2) Pedestrian plaza with benches;
 - 3) Water feature, except in the area south of US 40 where water features are discouraged because they may attract wildlife to airport-related areas;
 - 4) Clock tower;
 - 5) Or other such deliberately shaped area and/or a focal feature of amenity that, in the judgment of the appropriate decision-maker, adequately enhances such community and public spaces.
 - b. Any such areas shall have direct access to the public sidewalk network and such features shall not be constructed of materials that are inferior to the principal materials of the structure and landscaping.

8. Landscape Design

Design of proposed landscaping in relation to structures. Landscaping shall be in conformance with Section M, Landscaping, of this Overlay District.

L. Open Space Requirements

1. Open Space Requirements

All sites shall provide for 15 percent open space on the lot. The required green space area can be counted towards the open space requirements.

2. Use of Open Space

In its review of the development plan, the appropriate Plan Commission shall consider how the location of open space within the development meets the following criteria:

- a. The protection of unique topographical features such as slopes, streams, and other natural water bodies;
- b. The protection of wooded areas, individual trees of significant size, wetlands or other environmentally sensitive features;
- c. A more efficient use of land, including the reduction of land area disturbed for utility lines and motor vehicular access;
- d. The minimization of the alteration of natural site features through the design and situation of individual lots, streets and buildings;
- e. Diversity and originality in lot layout;
- f. The relationship of the development to the surrounding properties; and
- g. Implementation of the greenways, pathways and trail recommendations of the Ronald Reagan Corridor Master Plan, and the appropriate jurisdictions Parks and Recreation Plan and/or Comprehensive Plan.

3. Standards for Open Space

- a. All open space shall be accessible by way of road, bikeway, sidewalk or foot path. Such access shall not be through private property or by way of an easement over private property.
- b. Areas dedicated as open space shall be a minimum of thirty (30) feet wide in their smallest dimension.
- c. Areas dedicated as open space shall be free of all structures and buildings except for structures directly related to the purpose of the open space such as patio/seating areas, gazebos, pedestrian plaza's, decks and bridges.
- d. Bodies of water may have fifty percent (50%) of their total acreage counted as open space.

4. Ownership and Maintenance of Open Space

Unless otherwise agreed to by the Plan Commission, the cost and responsibility of land dedicated as open space shall be borne by the property owner.

5. Open Space Plan

An open space plan shall be submitted along with the development plan in accordance with the appropriate jurisdictions rules and procedures.

M. Landscaping Requirements

In reviewing the landscape requirements proposed to be constructed in the Overlay District, factors to be considered by the appropriate Plan Commission shall include but are not limited to the following:

1. Landscape Plan

The applicant shall submit a landscape plan to the appropriate Plan Commission as part of the development plan application, per this Ordinance. Appendix 3: Recommended Plant Species of the Ronald Reagan Corridor Master Plan, lists the plant material recommended for use in the landscaping of a property in the overlay district.

2. Areas to be Landscaped

a. Green Space Area

A thirty (30) foot green space required for all property fronting the parkway within the Overlay District shall be composed of plantings as per the requirements in the Ronald Reagan Design Guidelines Manual and Section M.5 of this Ordinance. The incorporation of walkways and bikeways into the design is encouraged; however, no parking areas, through roads, buildings, accessory structures, etc. shall be established within this area.

b. Foundation

Foundation plantings shall be included along the front and any side of buildings that is visible from the Ronald Reagan Parkway or has primary pedestrian access.

c. Parking Lots

Parking lots shall be designed per the parking lot standards specified in the local zoning ordinance for the underlying district.

d. Screening Areas

All air conditioning units, HVAC systems, exhaust pipes or stacks, overhead doors, legally non-conforming outside storage areas, and satellite dishes shall be integrated into the overall building design or screened from the Ronald Reagan Parkway and adjoining land uses, by means of walls, fencing, parapets, penthouse screens, landscaping, berms, camouflage or other approved method.

e. Medians

Medians shall be landscaped per the standards specified in Section M.8 of this Ordinance.

3. Landscaping Standards

a. Plant Standards

All plant material proposed to be used in accordance with any landscape plan shall meet the following specifications:

- 1) Shade trees: A minimum of two and one-half (2 ½) inch caliper.
- 2) Ornamental trees: A minimum of one and one-half (1 ½) inch caliper.
- 3) Evergreen trees: A minimum height of eight (8) feet.
- 4) Deciduous shrubs: A minimum height of eighteen (18) inches.
- 5) Evergreen shrubs: A minimum height of eighteen (18) inches.

b. Design Standards

- 1) Wherever possible native species shall be used in the landscaping throughout the Ronald Reagan Corridor.
- 2) The placement of shade trees in pedestrian areas shall be sited to provide the optimum amount of shade to pedestrians.
- 3) Landscaping shall conform to the local sight triangle standards set forth in the zoning ordinances for Hendricks County, and the Towns of Avon, Plainfield, or Brownsburg as appropriate.

4. Protection of Existing Trees

- a. To the greatest extent possible, existing trees shall be saved upon development of a property unless it can be demonstrated that the site design restrictions necessitate their removal.
- b. The determination of which trees shall be saved shall be guided by the following principles:
 - 1) The practicability of arranging site plan components around existing features. In general, plans for groups of structures should be designed so as to preserve tree masses, individual tree specimens, and small stands of trees. Natural woodland areas shall be protected wherever feasible.
 - 2) The condition of the vegetation with respect to continued vitality.
 - 3) The practical and economic possibility of designing the location and grades of proposed structures and paving to preserve existing vegetation.
 - 4) The desirability or lack thereof a particular tree or species by reason of its appearance, historic or ecological significance, botanical characteristics, and the function the vegetation would fulfill as a site plan component.
 - 5) The potential for interference with utility services or with passage or visibility along roads or walkways.
 - 6) The possibility of preserving the vegetation while meeting the development needs through pruning rather than removal.
- c. Development Plans for sites with existing trees or stands of trees in the Overlay District should make reasonable efforts to protect and incorporate them into the overall site design.
- d. Prior to the approval of the development and the issuance of an Improvement Location Permit, the developer shall inventory trees on the site which have a caliper of eight (8) inches or greater, following the “American Standard for Nursery Stock” standards that are intended to be saved. The inventory shall contain the location, size, and common name of an existing stand-alone tree, areas of dense trees or shrubs, and other natural features. Existing trees saved in the development of the site shall be credited toward the landscaping requirements as identified in sub-subsection e below.
- e. To encourage tree preservation, each tree preserved greater than eight (8) inch caliper shall convert as credits for required landscaping. Credits for each preserved eight (8) inch caliper tree shall be:

- 1) Two (2) required shade trees or
 - 2) Four (4) ornamental trees
- f. Barriers will be used to protect trees during the development of the site. Substantial barriers shall be specified on the landscape plan and shall be placed at or beyond the dripline of trees to be protected. These barriers shall remain in place during heavy construction on the site and no vehicles, machinery, tools, chemicals, construction materials, or temporary soil deposits may be permitted within the barriers, nor may any notice or other object be nailed or stapled to protected trees.

5. Green Space Area

The following standards in this Section shall apply to all lots located within the Overlay District and have frontage on the Ronald Reagan corridor. The primary landscaping materials used in the thirty (30) foot green space area, shall be shade trees, ornamental trees, shrubs, ground covers and grass. See Figure 3, Green Space Area Requirements.

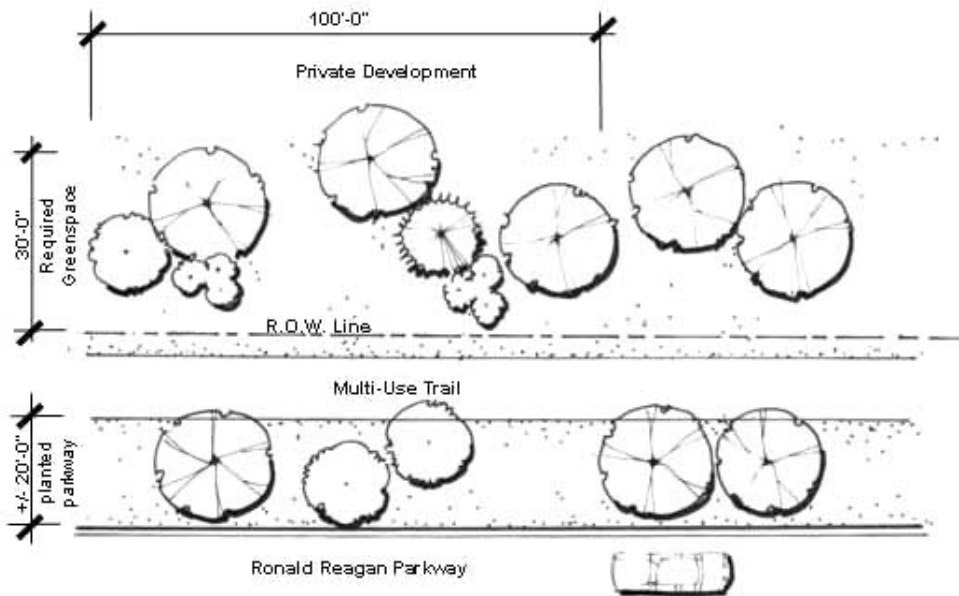

Figure 3: Green Space Area Requirements

- a. A minimum of three (3) shade trees, two (2) ornamental or evergreen trees, and six (6) shrubs shall be provided per one hundred (100) linear feet of green space area.
- b. Trees planted within the green space area parallel to the Ronald Reagan Parkway shall contribute to the overall natural character of the corridor. Trees

made be placed linearly or clustered in groups, with priority on natural patterns and clusters.

- c. Earthen mounds are required to screen parking lots fronting the Ronald Reagan Parkway. The earthen mound shall be covered with groundcover and shall have a minimum of three (3) shade trees, two (2) ornamental or evergreen trees, and six (6) shrubs per one hundred (100) linear feet and shall be parallel the Ronald Reagan Parkway as illustrated in Figure 4, Earthen Mound Requirements. The earthen mound shall be a maximum of five feet above surrounding grade and have rounded flanks. The mounds and landscape patterns shall maintain the natural appearance and character of the corridor.

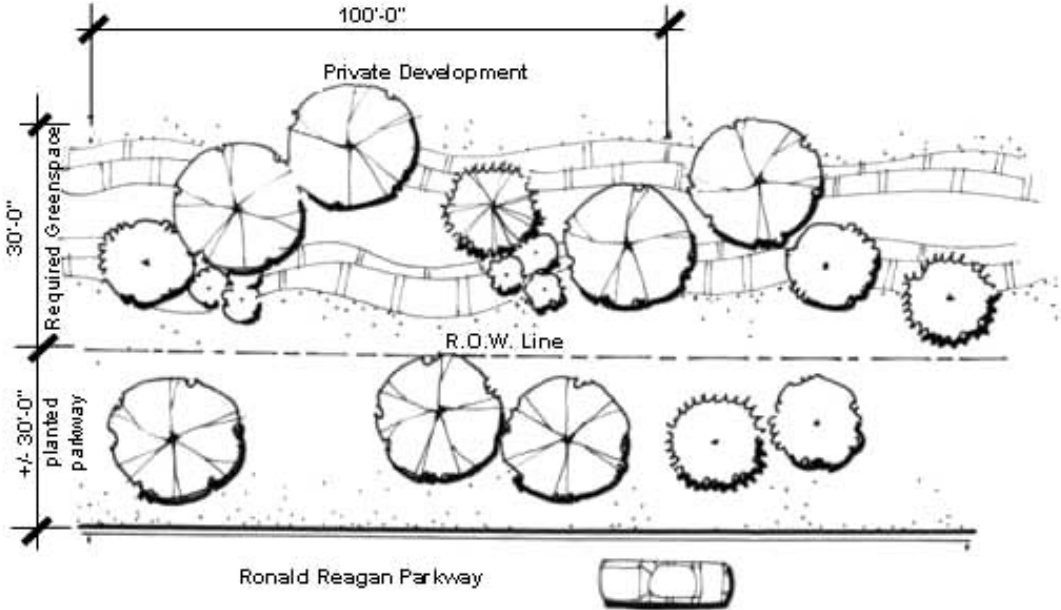

Figure 4: Green Space Area Requirements



Figure 5: Example of Earthen Mound

6. Foundation Plantings

- a. The primary landscaping materials used adjacent to buildings shall be shrubs, ground covers and ornamental grasses. Ornamental trees and perennials are also encouraged as accent plantings.
- b. The minimum width of the foundation planting area shall be five (5) feet, except that when adjoining a parking area located in the front yard adjoining the Ronald Reagan Parkway, the minimum width shall be ten (10) feet.
- c. In this foundation planting area, there shall be a minimum of twenty-five (25) shrubs per 100 lineal feet of planting strip. Shrubs can be placed linearly or clustered.

7. Parking Lots

a. Parking Lot Interior Planting

Where commercial, office, and industrial parking lots are located within the Overlay District, are located in the front or side yards of the building, and are visible from the Ronald Reagan Parkway:

- 1) A minimum of one (1) shade tree and two (2) shrubs shall be planted within each parking lot for every seven (7) spaces provided, or ten (10) trees per acre of parking, whichever is greater as illustrated in Figure 6, Interior Parking Lot Planting.



Figure 6: Interior Parking Lot Planting

b. Parking Lot Perimeter Planting

- 1) A six (6) foot wide perimeter planting area shall be provided along the front and sides of the entire parking lot as shown in Figure 7, Example Perimeter Planting Area.

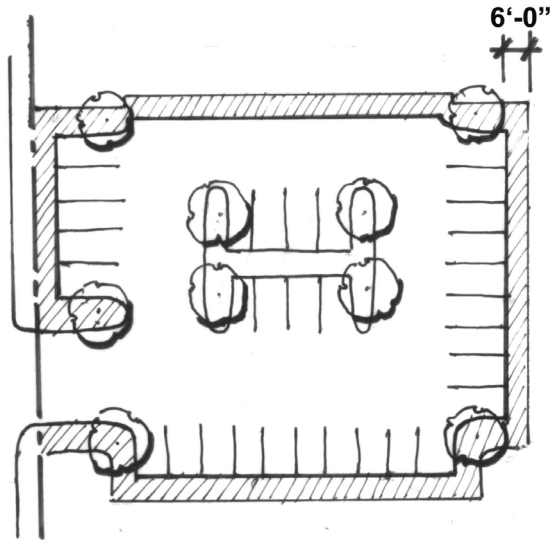

Figure 7: Example Perimeter Planting Area

- 2) If an earthen mound is used to screen the parking from the Ronald Reagan Parkway, additional perimeter planting shall not be required on the side that contains the earthen mound. However, the three (3) remaining sides shall be landscaped in accordance with the provisions set forth in this subsection.
- 3) The perimeter planting area shall be provided in addition to the green space area.
- 4) The required planting unit for this area shall include three (3) shade trees, two (2) ornamental or evergreen trees, and six (6) shrubs per one hundred (100) linear feet.

8. Median Landscaping Guidelines

These standards apply to all medians not located within the Ronald Reagan Parkway. All medians shall be a minimum of five (5) feet.

a. Plantings

- 1) Groundcover shall be incorporated into all median plantings. All medians shall be landscaped with a mixture of trees, shrubs, perennials, groundcovers, and annuals.
- 2) As a minimum there shall be one (1) tree and one (1) shrub per forty (40) linear feet.
- 3) The median plantings shall maintain the natural appearance and character of the corridor.

b. Sight Triangle

Sight triangle for visibility around median plantings shall be maintained in accordance with the local zoning ordinance requirements.

c. Paving materials

Paving accents such as brick or decorative pavers shall be incorporated into the median noses in a consistent manner with the Ronald Reagan Corridor Design Guidelines and Master Plan.

9. Landscaping Installation and Maintenance

a. Installation

All landscaping approved as part of the landscape plan portion of a development plan approval shall be installed prior to the issuance of a Certificate of Occupancy. If it is not possible to install the required landscaping because of weather conditions, the property owner shall post a bond prior to the issuance of the Certificate of Occupancy for an amount equal to 125 percent of the total installed cost of the required landscaping.

b. Maintenance

It shall be the responsibility of the owners and their agents to insure proper maintenance of all trees, shrubs and other landscaping approved as part of the landscape plan portion of development plan approval in accordance with the standards set by this Ordinance. This is to include, but is not limited to, replacing dead plantings with identical varieties or a suitable substitute approved by the appropriate jurisdiction enforcement official, irrigation and mulching of planting areas, and keeping the area free of refuse, debris, and weeds.

All dead plant material shall be replaced within one year or by the next planting season of their death or upon written notice of condition, except that during adverse weather conditions a longer period.

c. Changes after Approval

No landscaping which has been approved by the appropriate Plan Commission may later be materially altered, eliminated or sacrificed, without first obtaining further Plan Commission approval. However, minor alterations in landscaping may be approved by the appropriate jurisdiction enforcement official in order to conform to specific site conditions.

d. Inspection

The appropriate jurisdiction enforcement official or his/her designee may visit any tract within the Overlay District to inspect the landscaping and check it against the approved plan on file.

N. Parking Requirements

In reviewing the parking requirements proposed to be constructed in the Overlay District, factors to be considered by the appropriate Plan Commission shall include but are not limited to the following:

1. Parking Spaces required, and the dimensions of those Parking Spaces: See the appropriate standards from the local zoning ordinance.
2. Landscaping Standards: See Section M, 7 above for standards.
3. Parking requirements and design:
 - a. The required number of parking spaces is established in the local zoning ordinance for the underlying district.
 - b. There shall be an appropriate number of parking spaces reserved for use by handicapped individuals, per State and Federal requirements.
 - c. Direct, articulated pedestrian access shall be provided from the side street and parking area to the building's primary entrance.
 - d. Above grade, structured parking facilities shall have on all sides architectural features that are compatible with the principal building(s) with which they are associated.
4. Parking Lots shall be designed to provide coordinated access to parking areas on adjoining tracts or parcels within the Overlay District. As part of the development plan submission, the petitioner shall provide a site circulation plan that illustrates to the appropriate Plan Commission how coordinated access will occur relative to the overall Ronald Reagan corridor.
5. All parking areas and drives (including existing residential driveways) shall be paved with asphalt or concrete. Brick pavers or other decorative pavements may be used as accents in parking area design. Cast-in-place concrete curbs shall be used.

O. Signs

In reviewing the sign requirements proposed to be constructed in the Overlay District, factors to be considered by the appropriate Plan Commission shall include but are not limited to the following:

1. Signage Plan

The applicant shall submit a signage plan to the appropriate Plan Commission as part of the development plan application, per this Ordinance.

2. General Requirements

- a. In the Overlay District, signage shall be designed as an integral part of the architectural and landscaping plans. The colors, materials, and style of signage shall be architecturally compatible and accentuate the buildings and landscaping on the site. The colors, materials, and lighting of every sign shall be restrained and harmonious with the building and site to which it principally relates.
- b. Off premise signs shall be prohibited in the Ronald Reagan Overlay District Corridor, unless as otherwise specified in Section O, 3.
- c. All lettering or logos shall be prohibited on any awning in the Overlay District.
- d. Private traffic direction signs and pavement markings for the direction and control of traffic into, out of, and within the site shall conform to the Manual of Uniform Traffic Control Devices as published by the Indiana Department of Highways.
- e. The integration of development signage, particularly the sharing of signs to identify multiple businesses, is encouraged within the Overlay District. The appropriate Plan Commission shall have the authority to approve off-premise signage should it determine that such signage would promote the intent and purposes of the Ronald Reagan Corridor Overlay District. Any signage shall conform with the character of the corridor as outlined in the Ronald Reagan Corridor Master Plan.
- f. Every sign shall conform to the design regulations as specified in the Ronald Reagan Design Guidelines Manual.

- g. The number of graphic elements on a sign shall be held to the minimum needed to convey the sign's major message and shall be composed in proportion to the area of the sign face.
- h. Identification signs of a prototype design and corporation logos shall conform to the criteria for all other signs.

3. Off-Premise Sign Regulations

Off-premise signs shall only identify a building, business, profession or industry within the overlay district boundaries not fronting on the Ronald Reagan Parkway. Off-premise signs shall only be permitted by right for unified centers such as business parks, office parks, industrial parks and shopping centers under the provisions contained herein in the Overlay District. Only one such sign shall be displayed for each unified center.

Off-premise signs shall meet the following requirements:

- a. Such signs shall not exceed thirty-two (32) square feet in sign area for a sign mounted flat on a building, thirty-two (32) square feet for a monument sign, and thirty-two (32) square feet for a free-standing sign.
- b. Landscaping for unified center signs shall be in accordance with the standards in sub-subsection d, Sign Landscaping, below.
- c. Unified center signs shall resemble the character as depicted in Figure 8, Unified Center Sign.

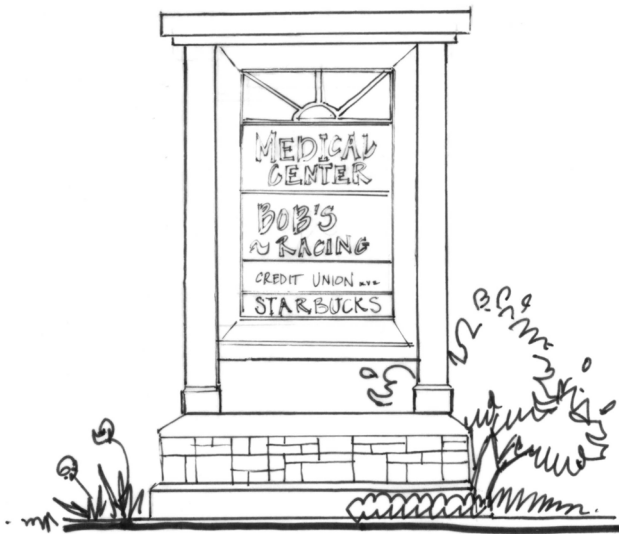

Figure 8: Unified Center Sign

d. Sign Landscaping

- 1) The landscaping plan for any signs shall be created, as follows:
 - a) A defined landscaped area shall be placed at the base of the sign in a method harmonious with the landscape concept for the whole site. Landscaping should be an attractive and dense cluster equally attractive in the winter and summer. The required landscaped area shall be parallel to the face of the sign.
 - b) Formal plantings shall be required at the base of all secondary gateway (monument) and unified center signs. These shall be a minimum three feet (3') wide planting bed along both sides of signs containing a mixture of ground cover, shrubs, perennials, and annuals arranged as illustrated in Figure 9, Sign

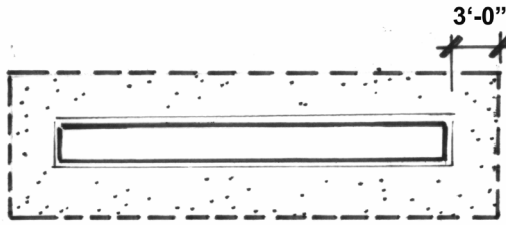

Figure 9: Sign Landscaping

- c) A landscaped area shall contain shrubs or perennials. The area shall be maintained to keep it free of weeds, debris, and brush.
 - d) Detailed drawings of the sign and landscaped area shall be submitted with the sign permit application for review.
 - e) Secondary gateway signs shall contain the Longshadow prairie planter and shall be landscape in accordance with the standards specified in the Ronald Reagan Design Guidelines Manual.
4. Wayfinding Signage
- a. Wayfinding signage shall be used to direct vehicular traffic to destinations in and near the Ronald Reagan Corridor. Parkway wayfinding signage shall be located within the right-of-way and shall meet the following criteria:
 - 1) Signs shall be free standing and located near intersections where they provide direction to local destinations for vehicular travelers. The signs shall not interfere with pedestrian accessibility.

- 2) Signs shall conform to the theme of the Ronald Reagan Corridor Master Plan. See Figure 10, Example Wayfinding Signage, as an example of approved signage. Signs shall be in accordance with the standards specified in the Ronald Reagan Design Guidelines Manual.



Figure 10: Example Wayfinding Signage

5. Gateway Signage

a. Locations

- 1) Major gateways shall be identified as the I-70 interchange, the Rockville Road/US 36 intersection, and the I-74 interchange.
- 2) Secondary Gateways shall mark entrances to public and private establishments.

b. Major Gateways

- 1) Major gateway signage shall be sited at Major gateways along the Ronald Reagan Parkway.
- 2) The major gateway signage shall incorporate the Ronald Reagan Parkway into its design.
- 3) Major gateway signage shall be constructed of natural materials consistent with the character of the Corridor as specified Ronald Reagan Corridor Master Plan and in accordance with the standards set forth in the Ronald Reagan Corridor Design Guidelines Manual illustrated in Figure 11, Example of Major Gateway.

- 4) Major gateways shall be of a scale appropriate for vehicular traffic as set forth in the Ronald Reagan Corridor Design Guidelines Manual.
- 5) Major gateways shall incorporate ornamental plantings, flags, and sculptural elements in accordance with the standards set forth in the Ronald Reagan Corridor Design Guidelines Manual.
- 6) Major gateways shall maintain appropriate line-of-sight as determined by local ordinance.

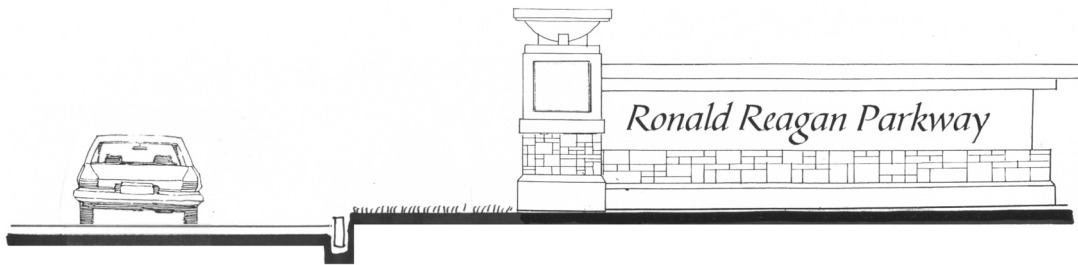

Figure 11: Example Major Gateway

c. Secondary Gateways

- 1) Secondary gateway signage shall be constructed of natural materials consistent with the character of the Corridor in accordance with the Ronald Reagan Corridor Design Guidelines Manual as shown in Figure 12, Example of Secondary Gateway.
- 2) Special accent plantings shall be used to highlight the gateway as a distinct area in accordance with the Ronald Reagan Corridor Design Guidelines Manual.
- 3) The signage shall be located within the thirty (30) foot green space area and shall maintain appropriate sight triangle regulations in accordance with local ordinance.

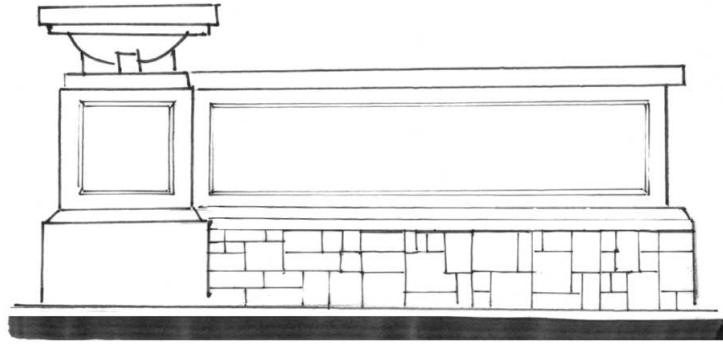

Figure 12: Example Secondary Gateway

P. Intersection Enhancements

1. All intersection enhancements shall be in accordance with the standards specified in the Ronald Reagan Corridor Design Guidelines Manual.
2. Pedestrian signals shall be installed at each intersection with a marked crosswalk.
3. Signalized intersections shall have marked crosswalks.
4. Marked crosswalks are strongly encouraged at non-signalized intersections.
5. Decorative paving and/or tactile surfaces are strongly encouraged at intersections and shall be in accordance with all Federal and State American Disabilities Act Standards.

Q. Bridge/Wall Treatments

1. Major Bridge
 - a. Bridges shall have enhancements including special wall treatments, parkway signage visible from the underpass, corridor lighting, and decorative railings and planters as specified in the Ronald Reagan Corridor Design Guidelines Manual and as illustrated in Figure 13, Example of Special Bridge Enhancements.
 - b. The bridge shall be well lit and shall contain a safe pedestrian passage in accordance with the standards specified in the Ronald Reagan Corridor Design Guidelines Manual.

- c. Bridges shall include a multi-use path at least twelve feet (12') in width. For additional multi-use path standards, see Section T and the standards specified in the Ronald Reagan Corridor Design Guidelines Manual.

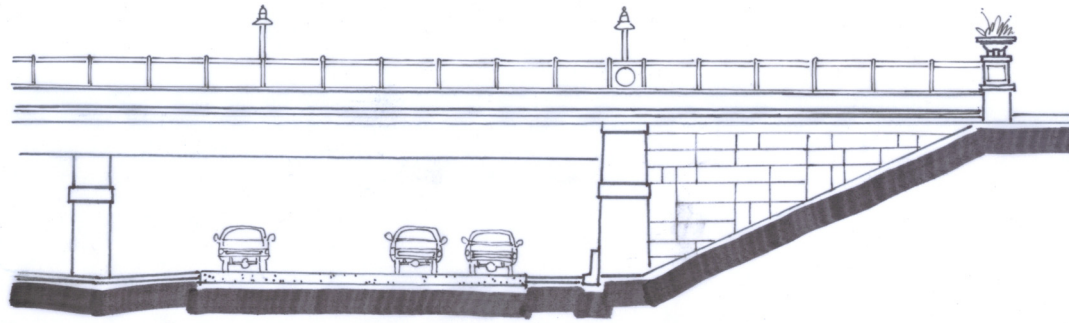

Figure 13: Example Special Bridge Enhancements

2. Minor Bridges

- a. The CSX bridge shall receive minor bridge treatments including corridor lighting consistent with the lighting standards of this Ordinance, decorative railings and planters developed in accordance with the standards specified in the Ronald Reagan Corridor Design Guidelines Manual.
- b. The bridge shall be well lit and shall contain a safe pedestrian passage in accordance with the standards specified in the Ronald Reagan Design Guidelines Manual.
- c. Bridges shall include a multi-use path at least twelve feet (12') in width. For additional multi-use path standards, see Section T and the standards specified in the Ronald Reagan Design Guidelines Manual.

3. Retaining Walls

- a. Retaining walls shall be utilized at entry drives for public and private establishments.
- b. Walls that are connected to buildings shall conform to the character of the building.
- c. Retaining walls that are not connected to buildings shall conform to the character of the Corridor as established in the Ronald Reagan

Corridor Master Plan and Design Guidelines by utilizing limestone and/or sandstone.

R. Lighting Requirements

A. Lighting Plan

A lighting plan for the proposed development within this Overlay District shall be filed as part of the development plan application, per Section B of this Ordinance.

B. Design

1. Lighting shall be configured in a manner that will not cause a false image of an aircraft runway. Where applicable and if in conflict with lighting standards for the airport or airport planning area, all FAA lighting standards shall prevail.
2. All lighting standards, including those on buildings, security lights and architectural lights within the Overlay District shall be of uniform design and material.
3. Parking lot and street lights shall also be of a uniform height not to exceed thirty (20) feet.
4. Lighting column foundations shall not extend more than 4" above the finished grade.
5. All fixtures with the exception of motion detector activated lighting shall be full cutoff and fully shielded.
6. Luminaries for such lights shall be in proportion to the pole diameter and height.
7. Lighting styles and designs shall be consistent with standards specified in the Ronald Reagan Design Guidelines Manual.

C. Intensity

All areas containing lighting shall limit light spillage onto adjacent property when measured at any point along a property line in accordance with the standards set forth below:

1. Lighting shall not cause illumination beyond any residential lot line or road right-of-way line in excess of 0.1 foot candles of light.

2. Lighting shall not cause illumination beyond any non-residential tract or parcel line or road right-of-way line in excess of 0.3 foot candles of light.
3. Compliance shall be achieved by utilizing fixture shielding, directional control designed into fixtures, fixture location, height, aim, or a combination of these or other factors.

S. Access to Individual Tracts

A. Access Restrictions

1. Consistent with the Ronald Reagan Corridor Master Plan, it is the intent of this ordinance to maximize safety and minimize disruption of traffic flow on the Ronald Reagan Parkway by directing access from abutting properties to existing or planned public streets that intersect with the Parkway.
2. Direct access to the Ronald Reagan Parkway shall be considered only where physical limitations and/or traffic impact studies show that there is no feasible option.
3. All median openings and traffic signals, if warranted, shall be at least one-half (1/2) mile apart in accordance with intersection space restrictions stated in the Ronald Reagan Corridor Master Plan.
4. Other access points, if approved, will be “right turn only” with no median opening.
5. The Ronald Reagan Parkway shall be an access managed highway, and access to individual tracts along this highway shall be gained by access roads if access does not exist.
6. In the Overlay District, common entrances shared by several properties and developments shall be required at the discretion of the Plan Commission.
7. In those cases where tracts can be accessed via connection to a primary or secondary arterial street as identified in the appropriate thoroughfare plan, a local street, or an adjoining parking lot, curb cuts shall not be established on the Ronald Reagan Parkway.
8. In order to preserve the aesthetic benefits provided by the green space area, access roads shall be provided at the rear of all tracts, whenever possible.
9. Access roads to contiguous tracts shall be coordinated so as to form one main access road serving adjoining developments. These roads should be designed so as to funnel traffic onto major arterial roads rather than into residential areas and roads that may adjoin or be near this Overlay District.

10. Access roads shall be designed to align with one another, where feasible.
11. The Plan Commission shall encourage maximum distances between curb cuts to the Ronald Reagan Parkway.

B. Traffic Impact Studies

Traffic Impact Studies shall be required for all new development proposed within the corridor that are expected to generate 100 or more new peak direction trips to or from the site. Traffic Impact studies shall meet the requirements of the local zoning ordinance. Specific traffic impact analysis requirements for individual developments shall be established with the Planning Director or his or her designee, with input from the County Engineer.

C. Design Standards

The design of drives, auxiliary (turn) lanes, tapers, paving blisters and other roadway elements shall be in compliance with local requirements for principal or primary arterials as identified in the local thoroughfare plan or Subdivision Control Ordinance. Entryways on cross streets shall comply with local requirements for the classification of the roadway being accessed.

T. Multi-Use Trail

1. A multi-use pathway shall be provided on the west side of the Ronald Reagan Parkway. The path shall be a minimum of twelve feet (12') in width and have a minimum twenty foot (20') buffer between the path and the roadway unless such a buffer is not feasible due to site constraints
2. The trail shall be designed and constructed in accordance to the standards specified in the Ronald Reagan Corridor Design Guidelines Manual and as shown in Figure 14, Section of Corridor with Multi-Use Path.
3. The path shall be connected to other planned or existing pathways to maximize opportunities for pedestrian circulation throughout the corridor. Pocket plazas associated with commercial or industrial uses are encouraged to establish links to the multi-use path. Mid-block pedestrian crossings are prohibited.
4. The multi-use path shall make accommodations for wheelchairs, bicyclists, strollers, and shall be in accordance with all applicable Federal and State American with Disabilities Standards. Decorative paving and/or tactile surfaces are encouraged at curb ramps and intersections.

5. Lighting along the multi-use path shall be pedestrian in scale and shall be in accordance with the standards specified in the Ronald Reagan Corridor Design Guidelines Manual. Wherever possible, shade trees shall be oriented to provide shade for the trail and pedestrian friendly elements such as water fountains, seating, and rest spots should be incorporated into the pathway.

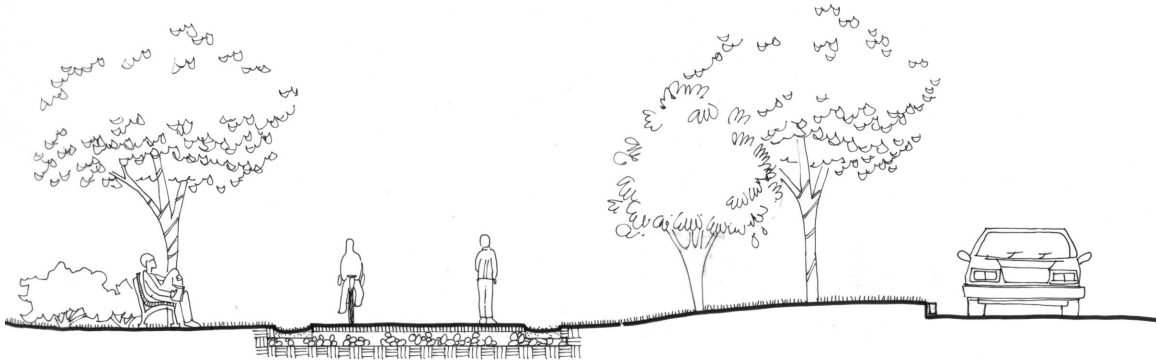

Figure 14: Section of Corridor with Multi-Use Path

U. Emergency Access

All emergency access areas and facilities shall be shown on the Site Plan and reviewed by the Fire Chief of the appropriate jurisdiction.

V. Other Requirements

In reviewing the other specified requirements identified below to be constructed in the Overlay District, the following factors shall be considered by the appropriate Plan Commission but are not limited to the following:

1. Outside Storage of Refuse
 - a. Unenclosed storage of refuse (whether or not in containers) or display of merchandise shall not be permitted on any property.
 - b. Refuse collection and recycling areas shall be in the rear of all buildings and limited from view by traffic along the Ronald Reagan Corridor. Trash receptacles shall be screened on three sides with a minimum six foot opaque wall consistent in materials with the primary structure or opaque plant materials as shown in Figure 15 and Figure 16, Screened Refuse Area.
 - c. All refuse collection containers shall be architecturally compatible with the principal building.

- d. No outside storage shall be permitted between an established Build-To Line and the Right-of-Way for the Ronald Reagan Parkway.



Figure 15: Screened Refuse Area



Figure 16: Screened Refuse Area

2. Loading Areas

- a. Loading areas are required per the regulations in the appropriate jurisdictions local ordinance and shall be identified on the development plan.
- b. Loading spaces and overhead doors shall be located at the rear or side of a building and shall be screened from view from the Parkway.
- c. Loading areas shall be screened using masonry wall(s), plant material, or a combination thereof as shown in Figure 17 and 18, Examples of Loading Area and, subject to Technical Review.



Figure 17: Example Loading Area



Figure 18: Example Loading Area

PREFERRED LAND USE SCENARIO

The final land use plan for the Ronald Reagan corridor utilizes some components of each of the various alternative development scenarios presented. During the creation of the preferred scenario, the local market was weighed against the goals of the County for economic development and the aesthetic character of the parkway. The alternative development scenarios were utilized in an exercise with the steering committee to invoke discussion and to provide a decision-making platform to establish the preferred land uses and characteristics that should be implemented in the final development scenario. Components of each scenario were discussed, and the result of this exercise was the development of the final scenario with consensus of the committee. The preferred land use scenario illustrated in **FIGURE 5.10** illustrates the outcome of this exercise and the final land use decisions made by the committee. The result is a land use plan that restricts residential development to areas in which it already exists, locates commercial development in concentrated nodes, emphasizes the need for hospitality uses in connection with local tourism and the airport, reserves land for professional office development, and provides land for a wide variety of industrial uses, including bulk warehousing and distribution. The preferred land use scenario is illustrated in **FIGURE 5.10** to the right, and larger scaled maps are illustrated in **FIGURE 5.11**, **FIGURE 5.12**, and **FIGURE 5.13**. Each land use is described below in the sections to follow.

Residential Land Use

The final land use plan restricts new residential development within the corridor study area. Existing neighborhoods under development will be permitted to continue to build out, but no new residential developments, whether single or multi-family, should be created. The land use plan for the corridor is intended to develop the land along the parkway for the purpose of economic development. Residential development would not only consume valuable commercial and industrially suited land, it would create new areas of conflict between residential and non-residential land uses.

FIGURE 5.10: Preferred Land Use Scenario

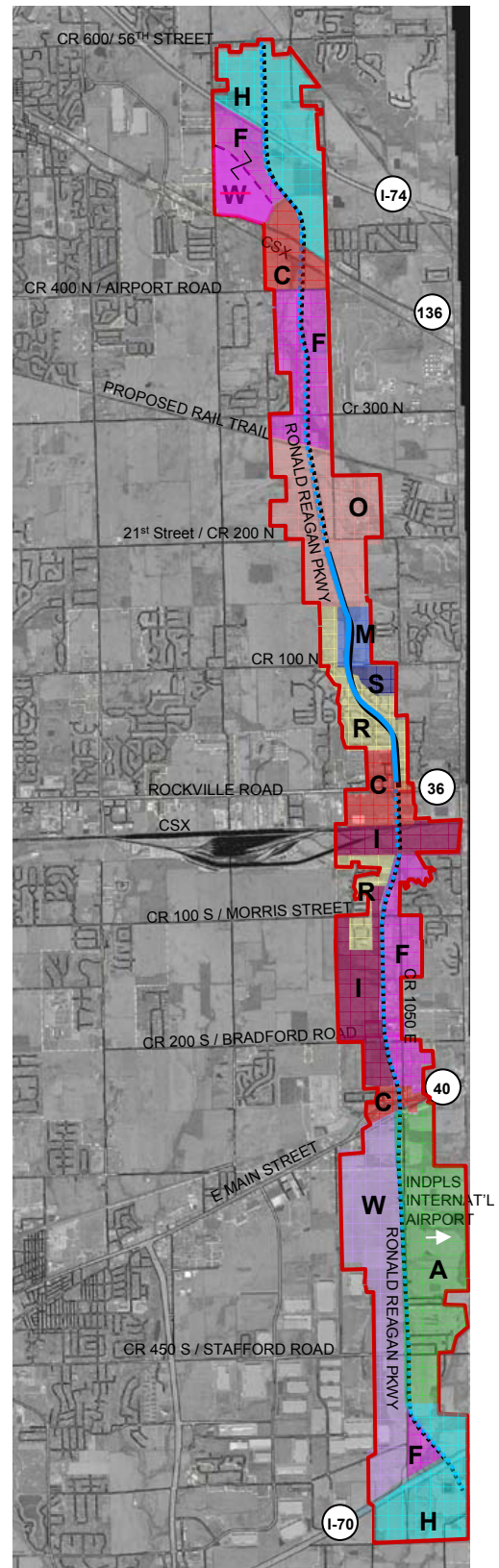

FIGURE 5.11: Preferred Land Use Scenario- North

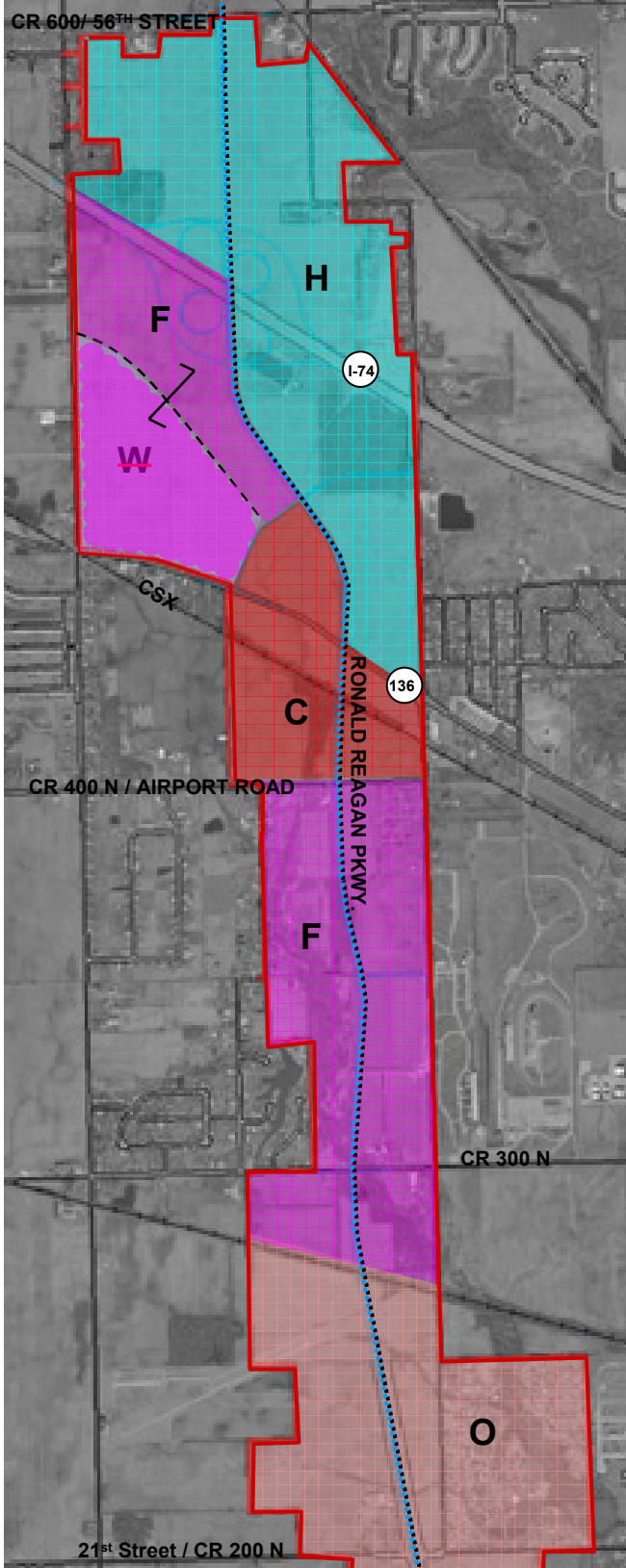
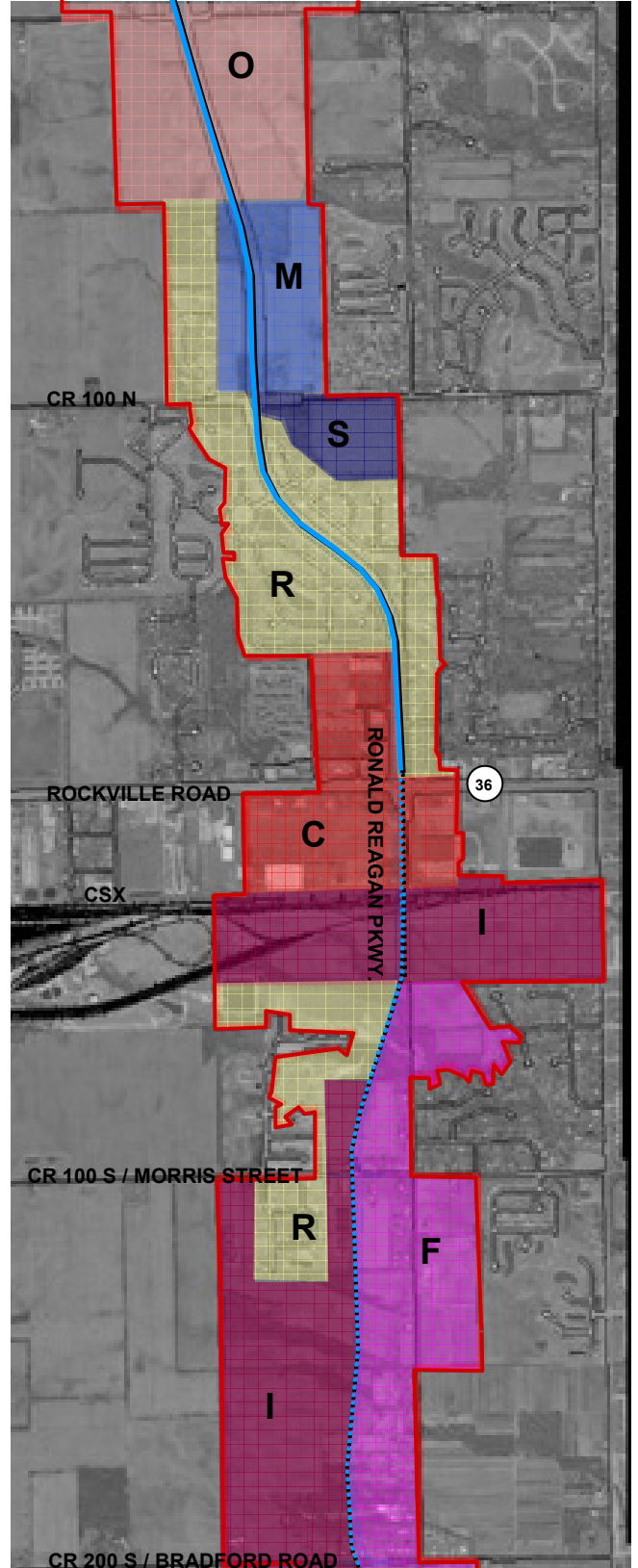

FIGURE 5.12: Preferred Land Use Scenario- Center



LAND USE RECOMMENDATIONS: 56TH ST. TO HENDRICKS/BOONE CO. LINE

During the master planning process, Hendricks County Commissioners met with the Boone County Commissioners about extending the roadway to Interstate 65 north of Hendricks County. In response, the design team was tasked with preparing a 4 mile extension of the project which focused on land use planning for the 4 miles north of 56th Street at the northern end of the study limits to the Hendricks County line. This exercise focused on developing a land use plan that supports the goals of the Ronald Reagan Master Plan by promoting the corridor as a premier business address and the continuation of design standards set forth in the Ronald Reagan Corridor Master Plan. It is anticipated that these planning efforts will eventually continue and future studies will examine the connections extending further into Boone County and connecting to I-65.

The future planning of this four mile extension is important because development pressures are anticipated in the long term, and proper planning will help to ensure a corridor that meets the goals and needs of the local communities. Immediate development pressures from Brownsburg will drive much of the development likely to occur up to 750N and eventually further north along the corridor. In addition, long term development pressures are anticipated as a result of growth from the City of Indianapolis as well as the planned new-town development Anson at I-65. Anson will stimulate the development of homes, offices, retail, and light manufacturing that will likely trickle down the corridor from Boone County.

Because much of this 4 mile segment is not likely to face immediate development pressures, it was determined that the land use plan should promote the long term vision of the corridor, while still allowing flexibility in its use designations. Two land use plans have been developed based on the current and anticipated development pressures along these portions of the corridor.

LAND USE PLAN: 56TH Street to 750N

The first land use plan extends from 56th Street to 750N. This area, because of its proximity to I-74, is facing more immediate development pressures than areas further to the north. The plan calls for an institutional campus at the site of future schools, a commercial node at 56th Street, natural areas, and some residential developments which have been slated to occur. This land use plan for areas south of 750N is illustrated in the figure below.

FIGURE A4.1: Land Use Plan- 56th Street to 750N

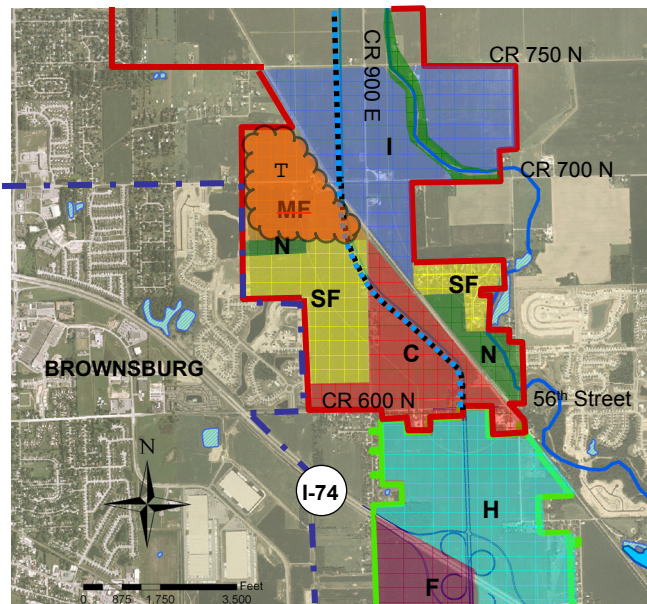

Land Uses:

- C** Commercial
- SF** Single-family
- I** Institutional/Office/School Campus
- N** Natural Areas/ Park
- T MF** Multi-family Transitional
- H** Hospitality
- F** Flex

LONG TERM VISION PLAN: 750N to COUNTY LINE

Land use planning north of 750N focuses on a bigger picture vision. Because of the lack of immediate development pressures, this scheme was developed to allow more flexibility. The long term vision for areas north of 750N to the County line is illustrated to the right. This plan designates land uses in the broader terms of regional employment areas and residential communities. Guidelines have been set for each type of land use designation.

Some portions have been set aside as residential communities in order to meet a demand for residential growth pressures from Brownsburg. In addition, residents will benefit from close proximity to local schools and convenient access to I-74. In keeping with the goals of the master plan, no low density residential development will be permitted in these areas.

The bulk of the corridor is designated as regional employment areas. These areas will provide lower-intensity development such as low scale office, warehouse, and flex space. This decision is in keeping with the goal of the master plan to establish a premier economic address along the corridor. All new residential uses will be excluded in these areas.

- 1 REGIONAL EMPLOYMENT AREAS**
 - Encourage non-residential lower-intensity development such as low scale office, warehouse, flex-space
 - Exclude all new residential uses
 - Promote economic development that supports the goals of the master plan

- 2 RESIDENTIAL COMMUNITIES**
 - Helps to meet a demand for residential growth pressures from Brownsburg
 - Convenient access to I-74
 - Encourage medium density residential development (no low density development)
 - Establish connection to schools and Greenways

- POTENTIAL PARKS/ NATURAL AREAS**

FIGURE A4.2: Long-Term Vision Plan- 750N to County Line

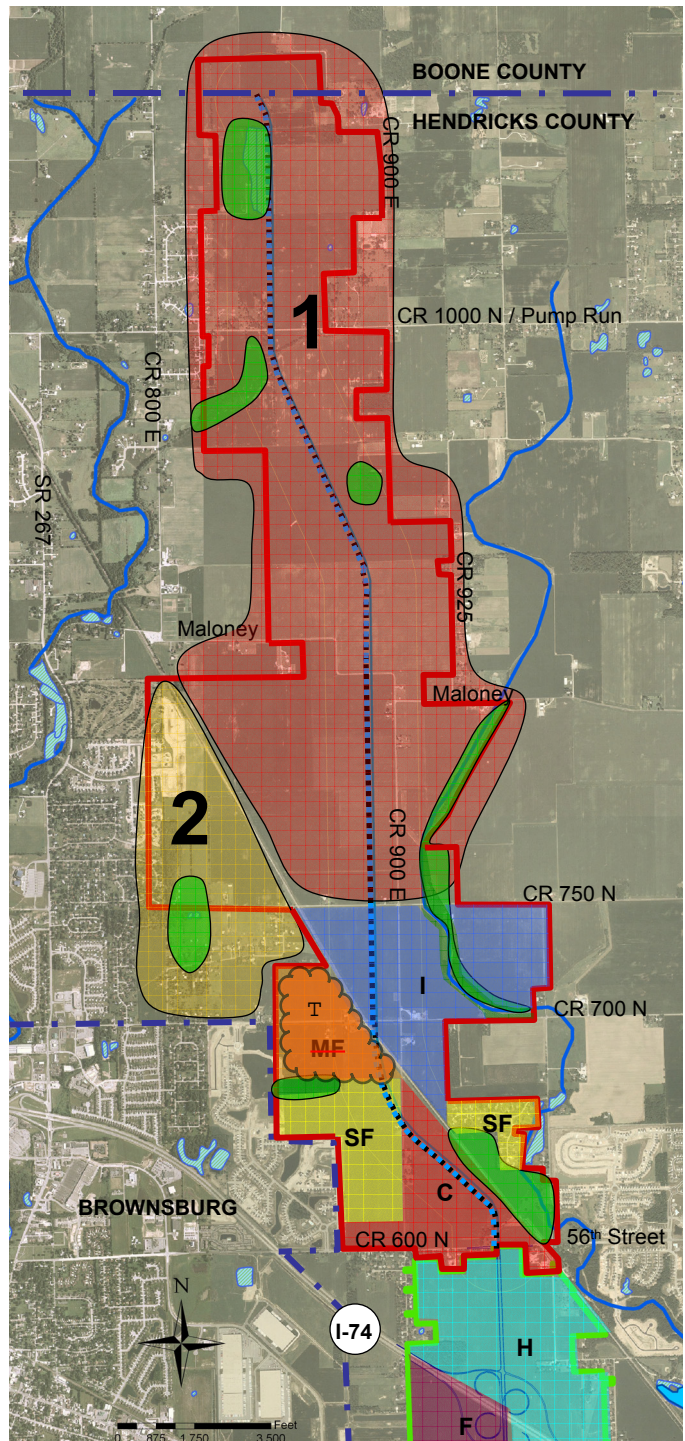

RESOLUTION

BY THE BOARD OF COMMISSIONERS OF HENDRICKS COUNTY, INDIANA, THE TOWN OF AVON, INDIANA, THE TOWN OF BROWNSBURG, INDIANA, THE TOWN OF PLAINFIELD, INDIANA, AND THE INDIANAPOLIS AIRPORT AUTHORITY

REGARDING THE INTER-GOVERNMENTAL AGREEMENT CONCERNING THE RONALD REAGAN CORRIDOR MASTER PLAN

This agreement between Hendricks County, Indiana, herein referred to as "County," and the Towns of Avon, Brownsburg, and Plainfield, Indiana, herein referred to as "Towns" and the Indianapolis Airport Authority, herein referred to as "Airport".

WHEREAS, the County, Towns, and Airport have collaborated over the past two decades in developing a long-term vision for the critical north-south roadway between Interstate 70 and Interstate 74, known as the Ronald Reagan Parkway; and

WHEREAS, the collaborative vision of this corridor recommends that this area be a premier economic development corridor with high-quality development standards; and

WHEREAS, more stringent planning controls are recommended to ensure the preservation of the corridor's accessibility and development quality; and

WHEREAS, the County, Towns, and Airport have an interest in the same geographic area referred to as the Ronald Reagan Corridor as illustrated in Exhibit 1; and

WHEREAS, portions of the Ronald Reagan Corridor are within the jurisdictions of the Hendricks County Plan Commission, the Avon Plan Commission, the Brownsburg Plan Commission, the Plainfield Plan Commission, and the Indianapolis Airport Authority;

WHEREAS, development along the Ronald Reagan Parkway impacts future development within the County;

WHEREAS, the County, Towns, and Airport want to make the development process as efficient as possible without compromising quality; and

WHEREAS, Indiana Code does not provide a mechanism that allows both the County and the Towns to review developments within an AREA OF COMMON INTEREST (ACI), herein referred to as ACI, but does allow Counties and Towns to enter into inter-governmental agreements.

NOW THEREFORE, in consideration of the mutual agreements set forth herein, the County, Towns, and Airport agree as follows:

1. THAT, the AREA OF COMMON INTEREST (ACI) shall be defined as the Ronald Reagan Corridor as shown in Exhibit 1.
2. THAT, all parties agree to adopt the Ronald Reagan Corridor Master Plan as the long range vision for this area, subject, however, to the qualifications contained in the Indianapolis Airport Authority's letter of August 4, 2004, a copy of which is attached hereto as Exhibit 2.
3. THAT, all parties agree to participate in a steering committee meeting as required, but not less than (1) once a year, to review the progress of the Ronald Reagan Corridor Master Plan. All parties agree to appoint at least one representative to the Ronald Reagan Parkway Steering Committee.
4. THAT, all parties will agree to utilize the model overlay ordinance contained in the Master Plan as a **BASE** document which they will then **REVIEW AND MODIFY FOR**

LOCAL CONDITIONS and adopt as an amendment to their zoning ordinance, if applicable.

5. THAT, the individual Plan Commissions, in order to maximize coordination, will route for comment any petition or development in the ACI that requires a hearing (rezoning, variance, special exception, conditional use, subdivision of land, development plan review, etc...) to the other Plan Commissions in the ACI and the Indianapolis Airport Authority as soon as possible. The Ronald Reagan Corridor Steering Committee shall conduct a series of workshops with the collective Plan Commissions and Indianapolis Airport Authority or designees thereof to establish a procedure for distributing, reviewing, and commenting on any petition described above within the ACI.
6. THAT, the local governments will use the standards identified in the Master Plan for construction of the various improvements within the right-of-way of the Ronald Reagan Corridor. This includes the suggested standards for the road cross section, landscaping, trails/sidewalks, median treatment signage, and other enhancements. Notwithstanding the foregoing the Indianapolis Airport Authority reserves the right to act in accordance with the Exhibit 2 qualifications and limitations contained therein.
7. THAT, all parties will agree to formulate a committee comprised of at least two (2) representatives from each jurisdiction that has participated in this agreement, with the intended purpose of developing an agreement between the jurisdictions with respect to the funding and maintenance of the Parkway and it's enhancements although it is acknowledged by all parties that participation of the Indianapolis Airport Authority in such an agreement may be limited due to the terms and conditions of the Federal Aviation Administration's Final Policy and Procedures Concerning the Use of Airport Revenue dated February 16, 1999.

NOW THEREFORE, such Inter-Governmental Agreement is passed and approved on this 12th day of April, 2005, by the following:

HENDRICKS COUNTY BOARD OF COMMISSIONERS,

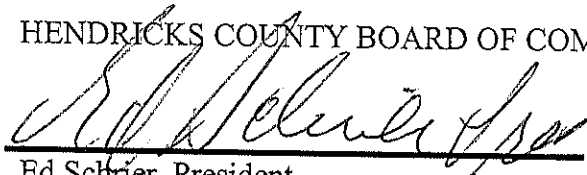

Ed Schrier, President

Sonya Cleveland, Member



Phyllis Palmer, Vice President

ATTEST:



Nancy Marsh, Auditor

NOW THEREFORE, such Inter-Governmental Agreement is passed and approved on this ___ day of April, 2005, by the following:

AVON TOWN COUNCIL,

Eva Yackey, President

Kathryn Miller, Member

Dave Jackson, Vice President

Mike Rogers, Member

David Cox, Member

ATTEST:

Sharon Howell, Clerk Treasurer

NOW THEREFORE, such Inter-Governmental Agreement is passed and approved on this ___ day of April, 2005, by the following:

BROWNSBURG TOWN COUNCIL,



Jeanette Baker, President

William Guarnery, Member



Robert Waggoner, Vice President



Charles E. Ratliff, Member



Michael J. Green, Member

ATTEST:



Jeanette M. Brickler, Clerk Treasurer

NOW THEREFORE, such Inter-Governmental Agreement is passed and approved on this ____ day of April, 2005, by the following:

PLAINFIELD TOWN COUNCIL,

Robin G. Brandgard, President , President

Daniel W. Fivecoat, Member

Kent McPhail, Member

Edmond L. Gaddie Jr., Member

Bill Kirchoff, Member

ATTEST:

Juliana Mitchell, Clerk Treasurer

NOW THEREFORE, such Inter-Governmental Agreement is passed and approved on this ____ day of April, 2005, by the following:

INDIANAPOLIS AIRPORT AUTHORITY,

Lacy M. Johnson, President

N. Stuart Grauel, Member

H. Patrick Callahan, Vice President

Shirley Haflich, Member

Alfred R. Bennett, Member

Robert H. Voorhies, Member

Kelly J. Flynn, Member

Michael W. Wells, Member

ATTEST:

Exhibit 1

RONALD REAGAN CORRIDOR

AREA OF COMMON INTEREST



Exhibit 2



Indianapolis Airport Authority • Indianapolis International Airport
managed by **BAA Indianapolis LLC**

Patrick F. Dooley
Airport Director

2901 S. High School Road
Indianapolis, IN 46224-4341
(317) 487-8884
www.indianapolisairport.com

August 4, 2004

Ron L. Taylor, ASLA, RLA
HNTB Urban Design
111 Monument Circle Suite 1200
Indianapolis, IN 46204

Dear Ron:

It has been my pleasure to serve on the Steering Committee for the Ronald Reagan Corridor Master Plan. We appreciate the opportunity to offer input and advice to the local governmental agencies that are coordinating this project.

We reviewed the draft Ronald Reagan Corridor Zoning Overlay District draft Ordinance with the Airport Authority Board and we discussed its impact on the Airport. It has been acknowledged by those on the Steering Committee that the Authority has the statutory power to exclusively determine the use of its property and therefore is not subject to local zoning Ordinances. However, it has been the policy of the Airport Authority to reasonably cooperate with local development standards as may be appropriate without compromising the ability of the Airport to maximize its ability to develop and function as efficiently as possible. Therefore, in the spirit of cooperation, the Authority's Board approved the following position statement with respect to the draft Ordinance and Master Plan:

As it pertains to development of Airport owned properties adjacent to the Ronald Reagan Parkway by the Indianapolis Airport Authority, the Indianapolis Airport Authority intends to reasonably cooperate with the spirit of the Ronald Reagan Corridor Overlay District subject to the exercise of best management practices for traditional airport development and management. The Authority advises that development of properties within the vicinity of the airfield may be constrained by statutory and operational considerations such as height restrictions on structures and vegetation, lighting layouts, the attraction of wildlife due to bodies of water and/or vegetation, noise impacts and various regulatory safety requirements to which airport operators are subject.

We are sharing this information with you and hope that you can incorporate it into the study records, and pass it on to the Steering Committee members as appropriate. Should you or others wish to discuss this further, please contact me at (317) 487-5306 and I will be happy to discuss it. We are available if any additional information or



Exhibit 2

participation is needed, and we look forward to the Corridor's development into a successful economic development tool and cohesive connector for the local communities.

Sincerely,

A handwritten signature in cursive script that reads "Lori Dunlap".

Lori Dunlap

CC: James Lemons, BAA Planning Manager
Dave Fleet, BAA VP of Planning and Engineering